



MPAC128 and MPAC128-ATEX

Megger Professional Acoustic Imager

User Guide

Register →
megger.com/register



 User Guide →
Firmware updates



Support →
megger.com/support



This document is copyright of:

Megger Limited, Archcliffe Road, Dover, Kent CT17 9EN. ENGLAND
T +44 (0)1304 502101 F +44 (0)1304 207342 www.megger.com

Megger Instruments Limited reserves the right to alter the specification of its products from time to time without notice. Although every effort is made to ensure the accuracy of the information contained within this document it is not warranted or represented by Megger Limited to be a complete and up - to - date description.

For Patent information about this instrument refer to the following web site:
megger.com/patents

This manual supersedes all previous issues of this manual. Please visit the Megger website to ensure that you are using the most recent issue of this document. Destroy any copies that are of an older issue.

Declaration of Conformity

Hereby, Megger Instruments Limited declares the MPAC128 and MPAC128-ATEX professional acoustic cameras have been built in conformity with the following European Directives where they apply:

2011/65/EU

2014/30/EU

2014/34/EUh

Hereby, Megger Instruments Limited declares that radio equipment manufactured by Megger Instruments Limited described in this user guide is in compliance with Directive 2014/53/EU. Other equipment manufactured by Megger Instruments Limited described in this user guide is in compliance with Directives 2014/30/EU and 2014/35/EU where they apply.

The full text of Megger Instruments EU declarations of conformity are available at the following internet address:

megger.com/eu-dofc

1. Introduction	6
1.1 Product description	6
1.2 Company website	6
2. Safety warnings and standards	7
2.1 Warnings, cautions and notes	7
2.2 Explosion-proof note clause MPAC128-ATEX	7
2.3 Safety warnings	7
2.3.1 Installation category definitions:	8
2.4 Safety, hazard and warning symbols on the instrument	8
3. Instrument overview	9
3.1 Instrument layout	9
3.2 Software interface	9
3.4 MicroSD card slot	10
3.5 USB-C communication socket	10
3.6 Tripod	10
3.7 Hand straps and shoulder strap	11
4. Operation	12
4.1 Dynamic range	12
4.2 Test frequency range	12
4.3 Function menu bar	12
4.4 Menu icons	13
4.4.1 Focus	13
4.4.2 Photo and video	14
4.4.3 Playback	14
4.4.4 Tagging	16
4.4.5 Acoustic	19
4.4.6 Display	20
4.4.7 System	20
4.5 More functions	23
4.5.1 Gas leak	23
4.5.2 Estimation of gas leakage	24
4.5.3 Partial discharge	24

5. Measurement advise	25
5.1 Capture sound source	25
5.2 Reflected sound	25
5.3 Noise interference	25
6. Maintenance	26
6.1 General maintenance	26
6.2 Cleaning	26
7. Battery information	27
7.1 About the battery	27
7.2 About charging the battery	27
7.3 Charge the battery	27
7.4 Optimising the battery life	28
8. Specifications	29
9. Accessories and equipment	31
9.1 Included accessories	31
10. Terminology	32
11. Calibration, repair and warranty	33
11.1 Return procedure	33
12. Decommissioning	34
12.1 WEEE directive	34
12.2 Battery disposal	34
13. Worldwide sales offices	35

1. Introduction

This guide explains how to use the Megger professional acoustic cameras MPAC128 and MPAC128-ATEX.

Please read the guide carefully before you start using the cameras.

1.1 Product description

MPAC128 and MPAC128-ATEX are hand-held professional acoustic imagers that support both audible and ultrasonic frequencies. The MPAC128-ATEX has a **II 3G Ex ic IIC T5 Gc** explosion-proof rating.

The cameras use microphone array beamforming technology to acquire, measure and visually display the sound source data, overlaid on a real time high definition video image. By integrating the sound source data with the video image, the changing sound source is dynamically displayed on the screen in the form of a “sound map”.

Both the MPAC128 and MPAC128-ATEX Professional Acoustic Cameras aid the detection of air or gas leaks in both compressed and vacuum systems, even in noisy industrial environments. When used in power systems, they can help to safely and quickly identify partial discharge where dielectric breakdown is occurring.

The cameras are designed and built for use in industrial applications where both moisture and dust may be encountered, with the case built from a strong and durable machined aluminium alloy.

The instruments are simple and convenient to operate. They require adjustment of only two parameters: the measurement frequency range and the dynamic range. They offer both picture and video capture modes, making data recording easy and flexible. Test results are can be downloaded from the removable microSD card, or via the USB-C port, to allow for analysis and report generation.

Please ensure all the safety warnings within this manual are read and understood before operating the cameras.

1.2 Company website

Occasionally an information bulletin may be issued via the Megger website. This may concern new accessories, new usage instructions or a software update. Check on the Megger website for anything applicable to your Megger instruments.

www.megger.com

2. Safety warnings and standards

These safety warnings must be read and understood before the instrument is used. Retain for future reference. The cameras should only be operated by suitably trained and competent people.

2.1 Warnings, cautions and notes

This user guide follows the internationally recognised definition of warnings, cautions and notes. These instructions must be adhered to at all times.

Description
WARNING : Indicates a potentially dangerous situation which, if ignored, could lead to death, serious injury or health problems.
CAUTION : Indicates a situation which could lead to damage of the equipment or environment.
NOTE : Indicates important instructions to be followed to perform the relevant process safely and efficiently.

2.2 Explosion-proof note clause MPAC128-ATEX

- This equipment is explosion-proof, its grade is **II 3G Ex ic IIC T5 Gc**. It must be used in accordance with the explosion-proof marks in explosive environments.
- When using in an explosive environment, do NOT remove or replace batteries or recharge the battery pack.
- In an explosive environment, do NOT connect any USB devices, external power supplies, chargers or other peripherals
- In an explosive environment, ensure that the silica gel baseplate stays firmly in place.
- Do NOT insert or remove the microSD card or connect the headset in an explosive environment.
- The electrical accessories provided with the MPAC128-ATEX are not to be used in an explosive atmosphere.

2.3 Safety warnings

- If the equipment is used in a manner not specified by the manufacturer, the protection provided by the equipment may be impaired.
- There are no user-serviceable parts inside the cameras; all servicing must be referred to Megger approved service centres.
- Check the camera for damage before use. The camera must NOT be used if any part of it is damaged.
- The camera must NOT be used in the case of malfunction or abnormal heat.
- Do NOT place or store the camera near a heat source, flame or in a high temperature environment.
- This camera contains a Lithium-ion battery.
 - The battery is NOT user serviceable. All servicing must be referred to Megger approved service centres.
 - Do NOT charge the battery in a high temperature environment (over 45 °C).
 - In the event of a battery cell leaking, do not allow the released fluid to come into contact with the skin or eyes.
 - If contact has been made, wash the affected area with plenty of water and seek medical advice immediately.

Safety warnings and standards

2.3.1 Installation category definitions:

CAT IV - Measurement category IV: Equipment connected between the origin of the low-voltage mains supply and distribution panel.







CAT III - Measurement category III: Equipment connected between the distribution panel and electrical outlets.

CAT II - Measurement category II: Equipment connected between the electrical outlets and user's equipment.

Measurement equipment may be safely connected to circuits at the marked rating or lower. The connection rating is that of the lowest rated component in the measurement circuit.

2.4 Safety, hazard and warning symbols on the instrument

This paragraph details the various safety and hazard icons on the instrument's outer case.

Icon	Description
	Conforms to the European Explosive Atmospheres (ATEX) directive (MPAC128-ATEX model only)
	Caution: Refer to user guide.
	UK conformity. This equipment complies with current UK legislation.
	EU conformity. Equipment complies with current EU directives.
	Conforms to relevant Australian Safety and EMC standards.
	Do not dispose of to landfill, in sewage systems or by fire.

3. Instrument overview

3.1 Instrument layout

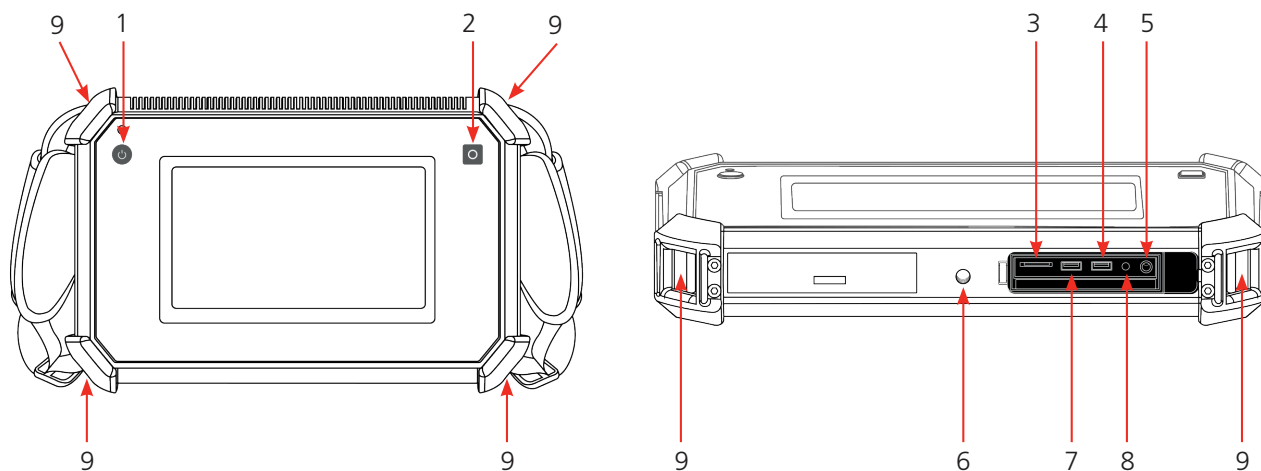

Item	Description	Item	Description
1	Power button	5	Headphone socket
2	Hot key	6	Threaded tripod mount
3	MicroSD card slot	7	USB-C Communication socket
4	USB-C Charging socket	8	Charging indicator LED
		9	Hand straps and shoulder strap points

3.2 Software interface

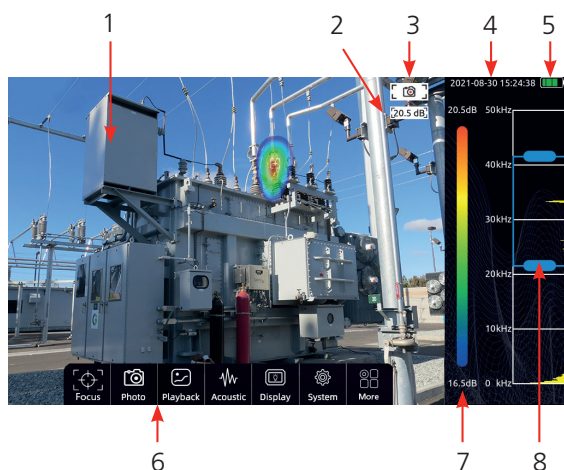

Item	Description	Item	Description
1	Video image display	5	Battery status indicator
2	Sound pressure level	6	Function menu bar
3	Photo/Video mode icon	7	Dynamic range quick setup
4	System time and date	8	Spectrum and frequency range box

3.4 MicroSD card slot

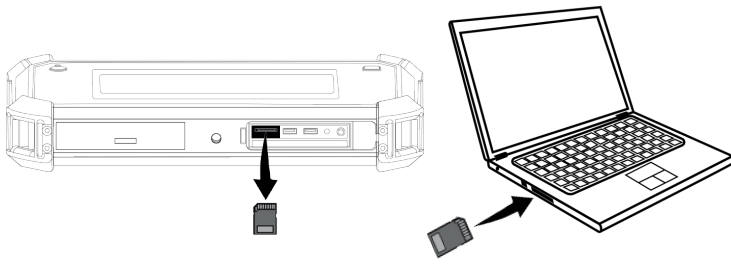

- Do not remove or insert the microSD card when video recording.
- After taking photos and recording videos, wait until the data is saved successfully before inserting the microSD card.
- Do not remove or insert the microSD card when browsing and marking data in the playback menu. Test data may not be correctly identified and displayed in the playback menu.

3.5 USB-C communication socket

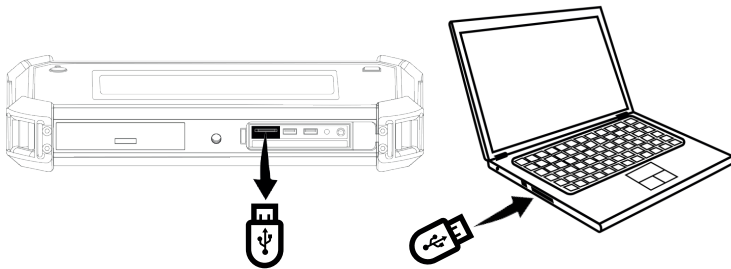

- Do not remove or insert the USB-C flash drive when video recording.
- After taking photos and recording videos, wait until the data is saved successfully before inserting the USB-C flash drive.
- Do not remove or insert the USB-C flash drive when browsing and marking data in the playback menu. Test data may not be correctly identified and displayed in the playback menu.
- Inserting either the USB-C flash drive or microSD card will initiate an automatic transfer of the images and videos stored in the camera's internal memory.
- The stored files can be transferred to the Acoustic Analysis software or downloaded for storage on a PC or laptop.

3.6 Tripod

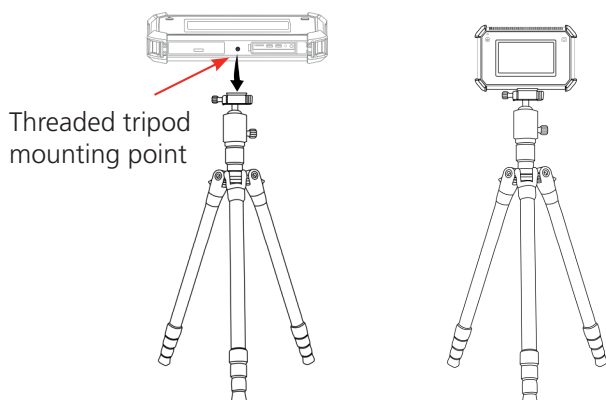

CAUTION : Ensure tripod and mount screws are tight and secure before use.

3.7 Hand straps and shoulder strap



Caution: ensure all strap connections are fitted correctly and secure before use.

4. Operation

4.1 Dynamic range

Tap the colour dB bar on the main interface to toggle the dynamic range slider bar on and off

Dynamic range slide bar will stay visible for about 5 seconds. Touch and move the slider to adjust the dynamic range.

Tap the colour dB bar to close

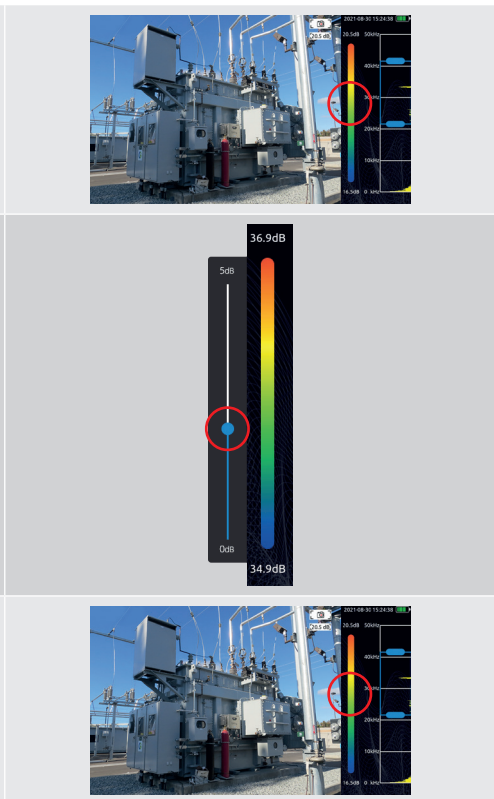

4.2 Test frequency range

Define the upper and lower limit of the frequency range by touching and sliding either of the box handles.

Maximum spread: 20 kHz

Touch and slide the centre of the selection box to move the defined range into position.

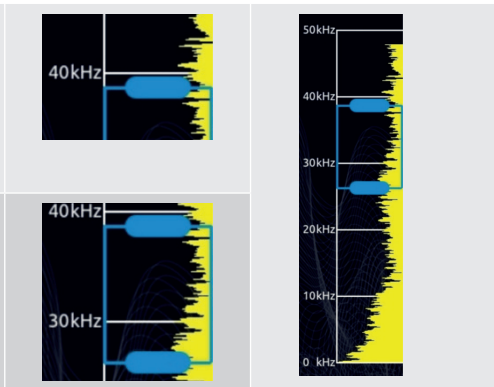

4.3 Function menu bar

- Tap the video display area of the screen to reveal the function menu bar.
 - If untouched, the menu will stay visible for about 5 seconds





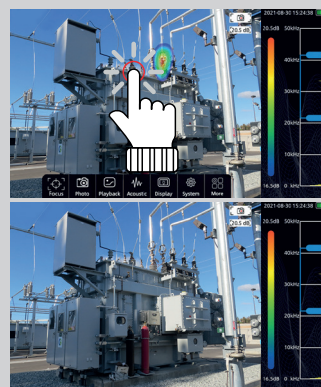



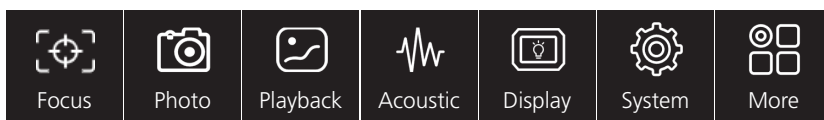

2. Tap the video area to toggle the function menu bar on and off.



4.4 Menu icons



Item	Description	Item	Description
 Focus	Turns on focus mode 4.4.1 Focus on page 13	 Acoustic	Acoustic settings menu 4.4.5 Acoustic on page 19
 Photo	Toggle photo/video modes 4.4.2 Photo and video on page 14	 Display	Display settings menu 4.4.6 Display on page 20
 Video		 System	System settings menu 4.4.7 System on page 20
 Playback	Playback: access stored videos and images 4.4.3 Playback on page 14	 More	Gas leak and partial discharge modes 4.5 More functions on page 23

4.4.1 Focus

When the measurement environment is noisy or there are multiple gas leaks/partial discharge occurrences, the focusing function can be used to display data on measurements within the focus ring only, eliminating interference.

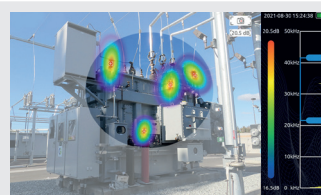

Double-tap the centre of the focus ring to reduce the size for pinpoint location.

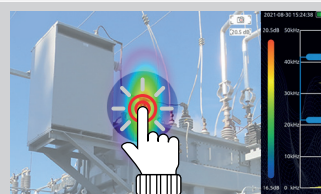

Double-tap again to restore the focus ring to its initial size. Focus is switchable in partial discharge mode and always on in gas leak mode.



Operation

4.4.2 Photo and video

Tap the **photo/video** button on the function menu bar to switch between photo (still picture) mode and video mode.

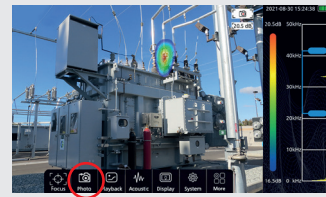
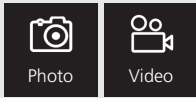

The icon in the upper right corner of the video image display indicates the current mode selected.



- In Photo mode, press the hot key (right) to save the displayed image
- In Video mode, press the hot key (right) to start recording and press again to stop; video recording will automatically stop after 5 minutes, the video is automatically saved.



During video recording, the elapsed time of the recording is visible next to the video icon.



Saved photos and videos are named by date and image number for that day.

4.4.3 Playback

Pictures and recorded videos can be viewed, deleted or have details added or deleted in the playback window.

Tap a photo or video to load the full-size image or play the video.



Tap **multi-select** (left), followed by the **list icon** (right) to select all the videos or photos. All will become highlighted. Individual photos and videos can be de-selected by tapping them individually.



To delete all selected images and videos, tap the **delete (bin) icon** in the top right hand corner.



To add detail information to selected images, tap the **pen icon**. A separate details box will appear. Tap the **save icon** to save the updated details.

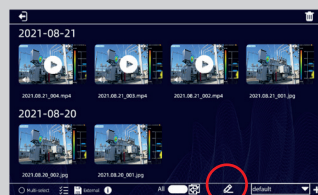

Tap the **information icon** to display used and available storage space.



The current file directory is shown on the screen. The arrow next to the directory name will bring up a list of available directories that can be selected. Files can then be accessed or saved to this directory.



The **+** icon, next to the directory name, allows a new directory to be created. A box will appear that allows the directory name to be entered, along with other details relating to the site. Tap the **save icon** to save the updated details.



Toggle the **All** slider to allow all new photo and video files to be copied into a new folder (the **'All'** folder) created on the microSD card. This makes accessing the individual photo or video files easier when downloading. Any photos or videos taken before this will need to be copied individually (see below).

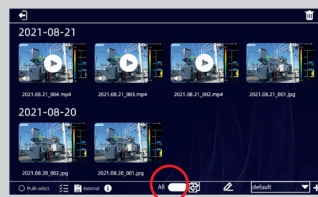

The **Copy** icon allows either individually selected photo or video files to be copied to the **'All'** folder, created on the microSD card.

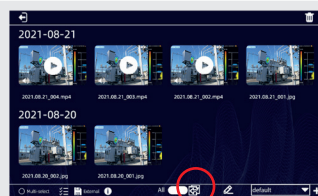

Picture playback

With a photo or video selected and displayed on the screen, pressing the **<** or **>** arrows will display the previous or next file.



Double tapping a photo will activate the zoom feature.

After enlarging, touch and slide the zoomed image to view specific parts of the original image; double-tap the picture again to restore it to its original size.

The zoom feature only operates with saved photo images.



Operation

Video playback

With a photo or video selected and displayed on the screen, pressing the < or > arrows will display the previous or next file.



Select a video file from the playback main screen.

Video playback starts automatically. Tap the screen to stop or restart playback.

Slide the progress bar below the video to navigate the playing position.

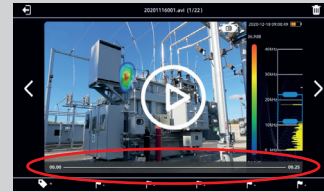

4.4.4 Tagging

Photo and video tagging

In Playback mode, tap a video or photo to bring up the tagging menu across the bottom of the screen.



Tap the **label icon** on the far left to add or edit the electrical or gas related parameters, relating to the file.

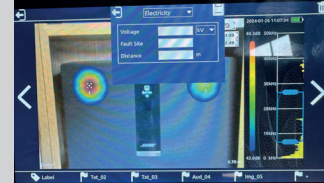

Tap a **flag icon** to mark a video or picture for tagging with an image, an audio recording or text.



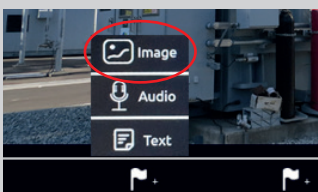
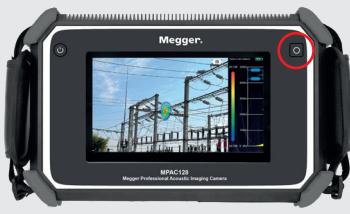
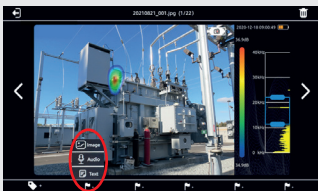
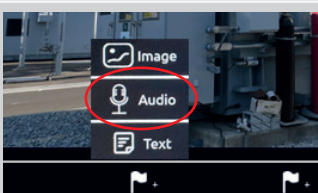

Image tagging

When tagging a photo, it is possible to add another image into the tag content, the image can be something that relates to the photo, such as a nameplate, warning sign or character tag, etc.

<p>Tap a flag icon to select the image markers.</p>	
<p>Tap Image. The visible light camera becomes active and the image is displayed.</p>	
<p>Press the hot key to take the photograph. This can then be saved, retaken or discarded by tapping the return icon.</p>	

Audio tagging

Audio tag can record an audio file as the tag content.

<p>Tap a flag icon to select the audio markers.</p>	
<p>Tap Audio. Ensure the microphone array is close to the source to improve quality of sound recording.</p>	
<p>Press the hot key on the right to record an audio using the front microphone array. Recorded audio files can be played back using the provided headphones. Press the hot key to save the audio file.</p>	

Operation

Text tagging

Tap a **flag icon** to select the text markers.



Tap **Text** and then tap the **keyboard icon**.



Text tag can be used to input a description. The instrument supports keyboard input and the two-dimensional code scanning.

Tap the input box to display the keyboard and type relevant information to be saved.

Tap the **Save icon** to save the content

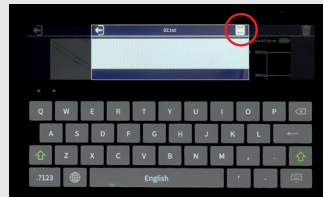

QR Code tagging

Tap a **flag icon** to select the QR code markers.



Tap **Text** and then tap the **two-dimensional code scan icon**.

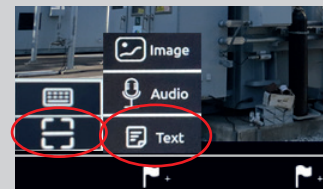

The device will start the camera to scan the QR code automatically.

When scanned successfully, the contents from the scanned QR code will be displayed.

Tap the **Save icon** to save the content or tap "Rescan" to scan the code again



4.4.5 Acoustic

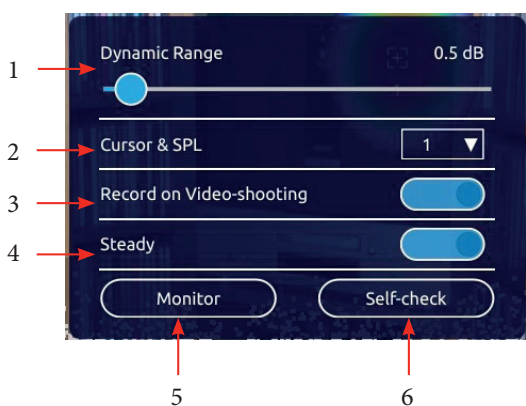

Item	Description	Item	Description
1	Dynamic range setting	4	Steady setting (On/Off)
2	Cursor and SPL setting	5	Monitor: ultrasonic monitoring settings
3	Record sound while recording video (On/Off)	6	Self-check settings

Dynamic range

Use the slider or touch the palette bar on the right of the screen to adjust the dynamic range.

Cursor and SPL (Sound Pressure Level)

Up to three cursors can be made active at the same time.

The Cursor and SPL function is displayed on the default Acoustic menu. Between 1 and 3 cursors can be selected to be displayed on the video screen with their cursor numbers below. The image energy at each cursor position will be displayed to the upper right: the sound pressure level at cursors 1, 2 and 3 will be displayed from top to bottom.

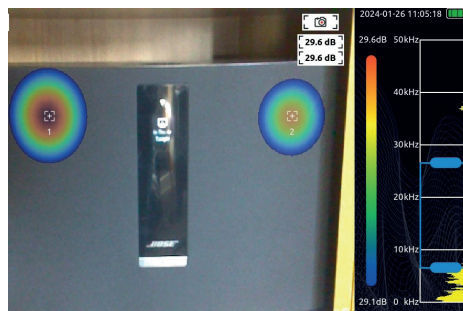

Record sound while recording video

Touch the **Record on Video-shooting** button to toggle audio on or off while recording video.

Steady

Touch the **Steady mode** button to toggle the steady mode on or off.

When the steady mode is turned off, the sound processor increases the response time to ensure transient signals are captured and fast changes of sound source can be identified. It is particularly suitable for locating rapidly changing partial discharge sound sources. With the steady mode on, the sound processor has a dampened response to ensure changing sound sources are displayed as a relatively stable images. This helps pin-point location of stable sound sources.

Monitor: ultrasonic monitoring

The equipment can modulate ultrasonic signals into the audible frequency band. The signal can be monitored as an audible sound using the headphones.

Tap Monitor to display the modulation controls. Tap the Switch button to turn the modulation on or off. Touch and move the reference frequency slider to find the best audible signal. It is recommended to use a frequency of about 38.6 kHz for near modulation and monitoring.

Self-check

The MPAC cameras have a built in self-test. This checks internal measurement components and the correct operation of the microphone array. In the event of any issue, contact a Megger Approved Service Centre. It is recommended the self-check is run on a regular basis to ensure optimum performance.

Operation

4.4.6 Display

The Display icon opens the display settings menu.

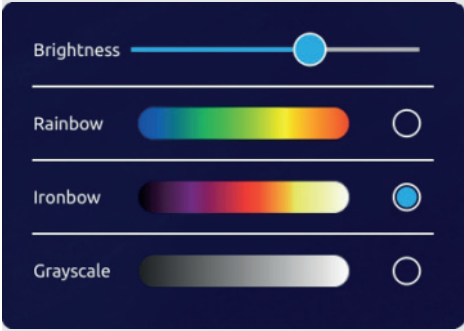
	Brightness	The brightness can be adjusted using the slider along with the colour palette. When used outdoors, it is recommended to increase the brightness for better visual clarity. When used indoors, reduce the brightness for a longer battery life.
	Rainbow	To change colour palette, select one of the 3 options available.
	Ironbow	to use rainbow palette.
	Grayscale	to use ironbow palette.

4.4.7 System

The System icon opens a range of settings that can be adjusted:



Item	Description	Item	Description
1	Language on page 20	4	Tool on page 21
2	Time on page 21	5	About on page 22
3	Lock on page 21		

Language

Multiple languages are supported by the MPAC cameras.

Tap the **Language icon** from the System menu bar to display the current languages.

The current language is displayed. Tap to view the drop-down list of available languages.

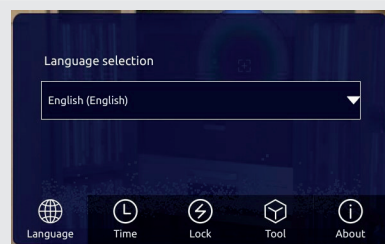

Tap the required language.

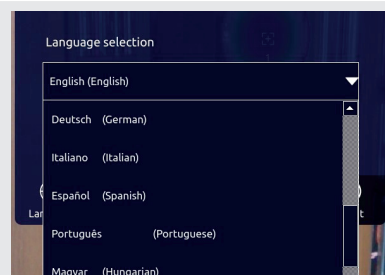

Time

The date and time is user-adjustable using simple scroll wheels

Tap the **Time icon** from the System menu bar to display the adjustable scroll wheels.

Touch and move the scroll wheels up and down to change the date and time in turn.

Tap **Update Time** to save.

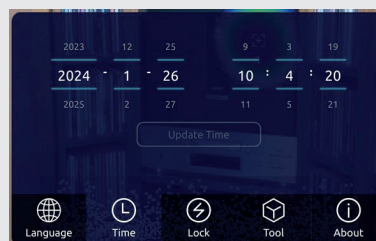

Lock

The lock menu opens the settings for **Auto sleep** and **Auto shutdown** functions. These can be turned on to save battery. When the auto sleep is active, the power indicator will flash.

Tap the **Lock icon** from the System menu bar to display the auto sleep and auto shut down options.

Select a time setting from the **Auto sleep** drop down menu. The device will automatically enter sleep mode if there is no user input for the specified time.

Press the power button to exit sleep mode.

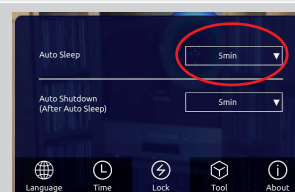

Select a time setting from the **Auto shutdown** drop down menu. The device will automatically shutdown if there is no user input for the specified time.

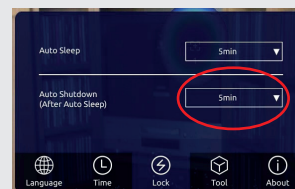

Tool

Tap **Export** and confirm **OK** to export the equipment operation log to the microSD card. The equipment operation log is used by the manufacturer to diagnose the equipment status, and users generally do not need to use it.

The **Threshold** setting is used to avoid low level interference. For example, if you set **Threshold** to 30dB, only sound sources with an SPL exceeding 30dB will be detected and imaged. The decibel level is adjusted by moving the slider.

High sensitivity is used for detecting minor faults by increasing the sensors sensitivity. However, activating this mode reduces the device's resistance to interference, so it is generally recommended to use it only in a quiet environment and when the fault point is close to the MPAC unit.

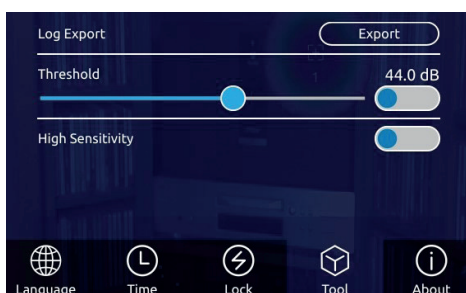

Operation

About

This displays the device model, serial number, software version and licence manufacturer information.



IP Address:

Press **IP**, to show the static IP address of the camera.

Using a USB-C to Ethernet cable, the camera can be connected directly to the PC/laptop to access the stored files.

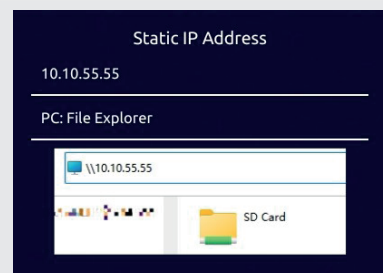

Update:

Download updates from the Megger website.

Save the updates to an external storage device (USB-C flash drive/microSD card).

Insert the external storage device into the MPAC.

Tap **Update** in the about icon to see the available packages saved on the external storage device and update the unit.



NOTE : Updates are released via the Megger website and can be downloaded free of charge.

Licence:

A user licence for the camera, if required, can be imported using an external storage device. If a licence has expired, the internal licence can be exported to the external storage device to be sent to Megger for authorisation.

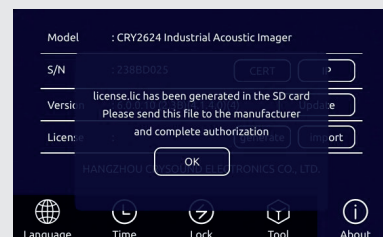

NOTE : Visit Megger website for downloading Analysis software or for firmware update.

4.5 More functions

The **More** menu function allows the user to switch between gas leak and partial discharge measurement modes

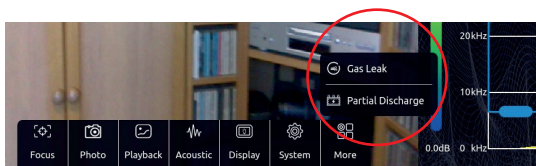

4.5.1 Gas leak

Tap the **Gas Leak** tab to bring up the gas leak menu.

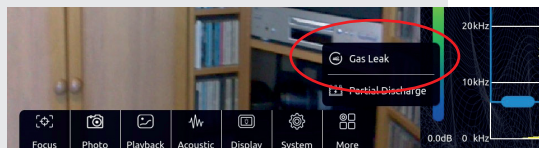

All displayed variables for gas leakage measurement and calculation can be edited.

See [4.5.2 Estimation of gas leakage on page 24](#) for more details



Setting different leakage correction values can make the measurement of leakage more accurate.

Tap the **Advanced** button to bring up the leak correction variable box, to correct the leakage amount

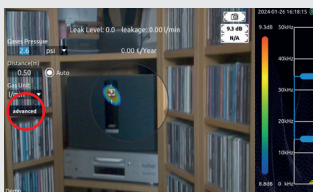

The default unit is ml/s. This can be changed under the **Gas Unit** drop down menu.

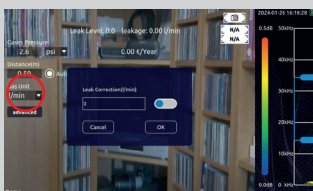

To set different leakage correction value, tap the button on the right to confirm and write the leakage value.

For example, if the device measures a leakage of 2 ml/s and the standard data is 5 ml/s, a more accurate measurement can be achieved by writing a correction value of 5 ml/s.

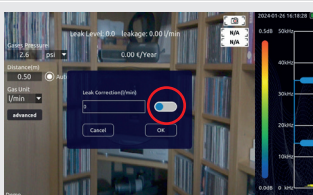

Operation

4.5.2 Estimation of gas leakage

Tap **Gas Leak** from the **More** option on the function menu to open the gas leak setting menu.

NOTE : Selecting **Gas Leak** will turn on **Focusing** by default to avoid interference.

Tap the **Gas Leak** button to select. Completing the input variables shown will allow the camera to carry out volume and cost calculations for the measured leak.

When measuring gas leaks, there are options to input the gas pressure and distance to the leak. The user needs to input the gas pressure and select measurement units and set the distance (in meters) to the measured leak, or set distance to Auto. The software will calculate and display the leakage level, leak rate and approximate cost per year. The gas leakage levels are divided into 7 levels and the corresponding leakage ranges for reference are shown:

Leakage Level	Leakage Range (Unit: ml / s)		Leakage Range (Unit: L / min)	
0	<0.167 ml/s		<0.01 L/min	
1	>0.167 ml/s	<1.667 ml/s	>0.01 L/min	<0.1 L/min
2	>1.667 ml/s	<16.667 ml/s	>0.1 L/min	<1 L/min
3	>16.667 ml/s	<166.667 ml/s	>1 L/min	<10 L/min
4	>166.667 ml/s	<1666.667 ml/s	>10 L/min	<100 L/min
5	>1666.667 ml/s	<16666.67 ml/s	>100 L/min	<1000 L/min
6	>16666.67 ml/s	<166666.7 ml/s	>1000 L/min	<10000 L/min

The actual leakage level displayed on the device is not an integer. Ceiling rounding method is used for the leakage levels provided in the above table.

For example, if a measured Leakage Level at a certain point is 2.1, with a leakage of 1.15 l/min, the corresponding standard Leakage Level would be 3 according to the table.

4.5.3 Partial discharge

Tap the **Partial Discharge** icon from the **More** menu bar to bring up the partial discharge menu.

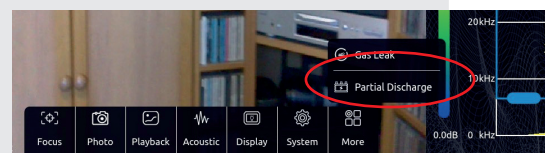

Tap the **PRPD (Phase Resolved Partial Discharge) Graph** toggle button can be switched on or off.

The **Sync Frequency** can be selected as 50 Hz or 60 Hz.



Partial discharge spectrum

Tap the **PRPD Graph** button to open and display the partial discharge spectrum.

The partial discharge spectrum is as shown in the image. Observing the characteristics of the spectrum can help users identify the discharge type. The internal algorithm will calculate and display discharge types when identified: Surface, Corona, etc.

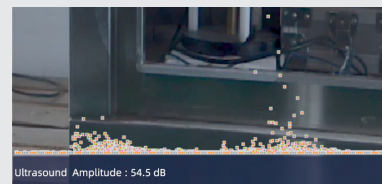

5. Measurement advise

5.1 Capture sound source

Observe whether there are prominent spectral signals or spectral spikes in the spectrum diagram. If there are, move the select box to include the frequency range where the prominent spectral signal or frequency spike is, and then observe if any sound source appears in the cloud image.

Adjust the dynamic range to a larger value, the device may simultaneously capture more than one sound source in the screen. When the SPL of multiple sources in the picture differ significantly, the relatively small dynamic range parameter may cause the larger sources to drown out the smaller one.

5.2 Reflected sound

When unable to determine if the sound source is an actual sound source or a reflection, move to view the sound source from different test positions. If the sound source remains steady, this indicates an actual sound source. A reflection may move or disappear when measured from different angles.

5.3 Noise interference

It is easy to be disturbed by environmental noise in the low frequency band. If possible, it is recommended to use mid to high frequency signals to identify the location of sound source.

A relatively narrow band range is always recommended to minimise or eliminate interference noise.

6. Maintenance

NOTE : There are no user replaceable parts within this product.

6.1 General maintenance

Keep acoustic sensor holes clean and prevent dust accumulation; if the holes have dust, blow air gently to clean using a lens cleaner blower/brush or similar.

When not in use for a long period of time, charge the battery and store at room temperature in the supplied carry case.

Regular inspection and charging can effectively increase service life of the battery.

6.2 Cleaning

Disconnect from mains power/charger.

Wipe the instrument with a clean cloth dampened with either water or isopropyl alcohol (IPA).

Do not use abrasive cleaners as damage may occur.

7. Battery information

7.1 About the battery

The MPAC128 series has an internal, 6600 mAh Lithium-ion rechargeable battery, which currently provides the best performance for your device. These batteries are lighter, charge faster, last longer compared to traditional batteries, and have a higher power density for more battery life. The MPAC128 will last about four hours use from a fully charged battery.

7.2 About charging the battery

The battery icon in the top-right corner shows the battery level or charging status.

All four bars lit up in the battery icon show its fully charged, as the battery discharges these bars will indicate the battery charge level.



If the battery is very low on power, it may display an image of a nearly depleted battery, indicating that it needs to be charged. If the battery is extremely low you may have to charge it for several minutes before you can use the MPAC128 again.

7.3 Charge the battery

1. Ensure the MPAC128 is switched off before and during charging.
2. Connect MPAC128 to a power outlet using the charging cable and USB-C power adapter (included) or other compatible power adapter (sold separately).

NOTE : You can also use third-party power adapters, the device supports the USB Power Delivery (USB PD) quick charging protocol through USB-C cable. It is recommended to use a power adapter or power bank that supports 12 V to 20 V voltage output and the minimum output power is not less than 15 W to charge the device.

3. When the battery is fully charged, battery icon in the top-right corner will show four solid bars on the battery symbol.
4. It is recommended to remove the charge cable from the MPAC128 when it is fully charged.

WARNING : If you suspect there may be liquid in the charging port of MPAC128, don't plug the charging cable into it.

7.4 Optimising the battery life

- Do not charge the device for more than 24 hours.
- If it is not used for a long time, please charge the battery regularly.
- If being stored without use, charge the device every two months to 80% (three bars).
- If used regularly, charge the device every week.
- For daily use, charge the device when battery level is below 30%.
- It is recommended to store the device within -20 °C to +45 °C.

NOTE : The battery has limited recharge cycles and may eventually need to be replaced. Battery life and charge cycles vary by use and settings. If you find yourself charging your device more frequently, it might be time for a new battery. The batteries should be serviced by Megger or an authorised service provider, do not disassemble the device. See the service contact section at the end of the user guide for more details.

8. Specifications

Specification	Detail
Acoustic Specification	
Microphone array	128 channels MEMS microphone
Effective test bandwidth	2 kHz – 48 kHz
Dynamic range	User adjustable, 0.5 dB to 12 dB
Test sound pressure level range	25.7 – 132.5 dBA
Auto max/min dB gain	User adjustable, minimum test bandwidth 1 kHz
Number of digits	24 bit
Sound image FOV	Horizontal: 62° Vertical: 48°
Sound image frame rate	At least 25 FPS
Detect distances	0.3 m – 120 m
Leak detection rate	1 m 7 bar 0.37 ml/s 10 m 7 bar 0.7 ml/s
Camera	
Camera FOV	Horizontal: 62° Vertical: 48°
Camera focal length	3.04 mm fixed focal length
Camera pixel	8 million pixel
Display	
Resolution	1024 x 600 pixels
Size	7 inch
Touch screen	Capacitive touch screen
Brightness	Adjustable
Photo notes	Up to 5 photos notes for reference
Source	Show single or multiple sources
Standard palettes	3: Grayscale, Ironbow, Rainbow
Playback function	View photos, videos anytime, and add notes or tags
Storage	
Internal storage	Up to 8 Gb
External storage	MicroSD card, USB-C memory stick, at least 64 Gb, expandable to 256 Gb
Data storage format	.jpg Picture, .mp4 Video .wav Recording
Video length	5 minutes
Digital export	MicroSD card, USB-C memory stick

Specifications

Power	
Battery capacity	1×6600 mAh @ 7.2 V Rechargeable battery
Battery life	~ 4 hours under full load state
Charger	USB Type-C port, USB Power Delivery (USB PD) protocol supported, 15 W
Power consumption	15 W for battery charge 29 W for maximum power consumption
Energy management	Sleep/Auto power off modes
Interface	
USB 3.0 Type-C USB host port	
3.5 mm headphone socket	
Operating Environment	
Operating environment	-20 °C to +50 °C, 10% to 95% no condensation
Storage temperature	-20 °C to +60 °C
Charging temperature	10 °C to +45 °C
General Specification	
Ingress Protection (IP)	IP54
Size	272 mm × 174 mm × 42 mm
Weight	1.7 kg
Warranty	2 years
Self-diagnostic notification	Array-health test function to identify when microphone array needs attention
System	Linux system
Certification	CE, FCC, RoHS-compliant, MSDS, CNEX, ATEX-II 3 G Ex ic IIC T5 Gc
Supported Language	English, Dutch, French, Chinese, German, Hungarian, Italian, Japanese, Korean, Norwegian, Polish, Portuguese, Russian, Spanish, Swedish
Software	
Report types	Gas/Electricity, ISO 50001 compliant
Analysis	Waveform, spectrum, spectrogram, leakage assessment, discharge type discrimination

9. Accessories and equipment

9.1 Included accessories

Item	
Hand straps	
Shoulder strap	
Universal mains charger	
USB-C charge cable	
Headphones	
Hard protective carry case	
8 Gb microSD card	
USB-A microSD card reader	
8 Gb USB-C/USB-A memory stick	
Cleaning tool	

10. Terminology

USB Power Delivery (USB PD)	A power delivery protocol based on USB3.1, which is often used to transmit higher power using a USB interface.
Decibel (dB)	A ratio used to express the magnitude of sound waves compared to a reference level at 0 dB.
Sound Pressure Level (SPL)	A physical quantity used to express the magnitude of sound waves, in decibels (dB). Also expressed as dBSPL.
Audible domain	The frequency range of sound that can be perceived by human ears normally 20 Hz to 20 kHz.
Ultrasonic	Frequencies higher than the human ear can perceive, normally >20 kHz.
Sound image	The two-dimensional data table representing the intensity distribution of sound sources in the space plane after the signal collected by microphone array is calculated by the sound source location algorithm.
Palette	The colour data used in the colour mapping of a sound cloud chart.
Sound cloud image	The sound pressure level data of each resolution point on the sound image is mapped on the palette (according to a conversion formula) to form a colour image, which is superimposed over the visible image to form a sound cloud image.
Test frequency range	When a defined frequency range is selected within the full frequency range supported by the device, the device will measure and display a sound cloud image/sound map that is within the defined range. Sound outside this frequency range will not be displayed.
Frequency peak	Denotes a strong sound energy distribution at a particular frequency.
Dynamic range	The scale of the intensity of the sound source that can be shown on the sound cloud image/sound map.
Field of view	For the camera and the microphone array, the solid angles subtended by the edges of their respective images to the face of the instrument.

11. Calibration, repair and warranty

Warranty Period: Two years from the date of purchase.

Megger operate fully traceable calibration and repair facilities to make sure your instrument continues to provide the high standard of performance and workmanship that is expected. These facilities are complemented by a worldwide network of approved repair and calibration companies, which offer excellent in-service care for your Megger products.

Within two years from the date of purchase, we provide free warranty service for abnormal, and malfunction caused by product quality. Free warranty service does not include the non-product quality problems caused by improper use, accidental drop, etc.

In case of equipment failure caused by improper use or accidental drop, we promise to provide maintenance service at cost price.

The equipment has been calibrated when delivered to the user. However, in the long-term use process, we suggest that you send the equipment to our office every two years for equipment calibration, testing and maintenance.

For service requirements for Megger instruments contact:

Megger Limited
Archcliffe Road
Dover
Kent
CT17 9EN
U.K.
Tel: +44 (0) 1304 502 243
Fax: +44 (0) 1304 207 342

11.1 Return procedure

WARNING : DO NOT remove the battery cells before shipping this instrument. The MPAC can only be shipped via land or sea freight with the Lithium-ion batteries installed. The MPAC cannot be shipped by air freight. Faulty battery modules MUST NOT be shipped to Megger or anywhere else.

1. When an instrument requires recalibration, or in the event of a repair being necessary, a Returns Authorisation (RA) number must first be obtained from one of the addresses shown above. The following information is to be provided to enable the Service Department to prepare in advance for receipt of your instrument and to provide the best possible service to you:
 - Model (for example, MPAC128).
 - Serial number (found on the display in the system/about menu, on the instrument label or on the calibration certificate).
 - Reason for return (for example, calibration required, or repair).
 - Details of the fault if the instrument is to be repaired.
2. Make a note of the RA number. A returns label can be emailed or faxed to you if required.
3. Pack the instrument carefully to prevent damage in transit. Use the original carry case if possible.
4. Before the instrument is sent to Megger, freight paid, make sure that the returns label is attached or that the RA number is clearly marked on the outside of the package and on any correspondence. Copies of the original purchase invoice and packing note should be sent simultaneously by airmail to expedite clearance through customs. In the case of instruments which require repair outside the warranty period, an immediate quotation can be provided when obtaining the RA number.
5. Track the progress on line at www.megger.com.

12. Decommissioning

12.1 WEEE directive



The crossed out wheeled bin symbol placed on Megger products is a reminder not to dispose of the product at the end of its life with general waste.

Megger is registered in the UK as a Producer of Electrical and Electronic Equipment. The Registration number is WEE/ HE0146QT.

For further information about disposal of the product consult your local Megger company or distributor or visit your local Megger website.

12.2 Battery disposal

The crossed out wheeled bin symbol placed on a battery is a reminder not to dispose of batteries with general waste when they reach the end of their usable life.

For disposal of batteries in other parts of the EU contact your local Megger branch or distributor.

Megger is registered in the UK as a producer of batteries (Registration number: BPRN00142).

For further information see www.megger.com.

13. Worldwide sales offices

Sales Office	Telephone	Email
UK	T. +44 (0)1 304 502101	E. UKsales@megger.com
USA – Dallas	T. +1 214 333 3201	E. USSales@megger.com
USA – Valley Forge	T. +1 214 333 3201	E. USSales@megger.com
USA – Dallas	T. +1 214 333 3201	E. USSales@megger.com
DEUTSCHLAND – Aachen	T. +49 (0) 241 91380 500	E. info@megger.de
SVERIGE	T. +46 08 510 195 00	E. seinfo@megger.com
AUSTRALIA	T. + 61 2 9397 5900	
中国	T. +86 512 6556 7262	E. meggerchina@megger.com
中国 - 香港	T. +852 26189964	E. meggerchina@megger.com
ČESKÁ REPUBLIKA	T. +420 222 520 508	E. info.cz@megger.com
AMÉRICA LATINA	T. +1 214 330 3293	E. csasales@megger.com
ESPAÑA	T. +34 916 16 54 96	E. info.es@megger.com
SUOMI	T. +358 08 510 195 00	E. seinfo@megger.com
LA FRANCE	T. +01 30 16 08 90	E. infos@megger.com
ΕΛΛΑΔΑ	T. +49 (0) 9544 68 0	E. sales@sebakmt.com
MAGYARORSZÁG	T. +36 1 214-2512	E. info@megger.hu
ITALIA	T. +49 (0) 9544 68 0	E. sales@sebakmt.com
日本	T. +44 (0)1 304 502101	E. UKsales@megger.com
한국	T. +1-800-723-2861	E. sales@megger.com
ضاي رلا بة رعل	T. +966 55 111 6836	E. MESales@megger.com
ن بة رلة كة لمم	T. +973 17440620	E. MESales@megger.com
NEDERLAND	T. +46 08 510 195 00	E. seinfo@megger.com
NORGE	T. +46 08 510 195 00	E. seinfo@megger.com
POLSKA	T. +48 22 2809 808	E. info.pl@megger.com
PORTUGAL	T. +34 916 16 54 96	E. info.es@megger.com
ROMÂNIA	T. +40 21 2309138	E. info.ro@megger.com
РОССИЯ	T. +7 495 2 34 91 61	E. sebaso@sebaspectrum.ru
SLOVENSKO	T. +421 2 554 23 958	E. info.sk@megger.com
SOUTH AFRICA	T. + 27 (031) 576 0360	E. sales.rsa@megger.com
TÜRKIYE	T. +46 08 510 195 00	E. seinfo@megger.com

Local Sales office

Megger Limited
Archcliffe Road
Dover
Kent
CT17 9EN
ENGLAND
T. +44 (0)1 304 502101
F. +44 (0)1 304 207342

Manufacturing sites

Megger Limited
Dover, ENGLAND
T. +44 (0)1 304 502101
E. uksales@megger.com

Megger AB
Danderyd, SWEDEN
T. +46 08 510 195 00
E. seinfo@megger.com

Megger Valley Forge
Phoenixville, PA USA
T. +1 610 676 8500
E. USsales@megger.com

Megger USA - Dallas
Dallas, TX USA
T. +1 214 333 3201
E. USsales@megger.com

Megger USA - Fort Collins
Fort Collins, CO USA
T. +1 970 282 1200

Megger GmbH
Aachen, GERMANY
T. +49 (0) 241 91380 500
E. info@megger.de

Megger Germany GmbH
Baunach, GERMANY
T. +49 (0) 9544 68 - 0
E. baunach@megger.com

Megger Germany GmbH
Radeburg, GERMANY
T. +49 (0) 35208 84-0
E. radeburg@megger.com

This instrument is manufactured in China.

The company reserves the right to change the specification or design without prior notice.

Megger is a registered trademark.

The Bluetooth[®] word mark and logos are registered trademarks owned by Bluetooth SIG Inc., and are used under licence.