

SMARTFUSE250

Megger[®]
Power on

Monitoring and fault location in the low-voltage grid. Simple. Safe. *Smart.*

- Real-time monitoring and analysis of current and voltage progression
- Early warning of impending grid overload
- Automatic restoration of power supply
- Minimised downtimes
- Cable fault location with households connected
- Modular multipolar design

Available as 1-, 2- and 3-phase system

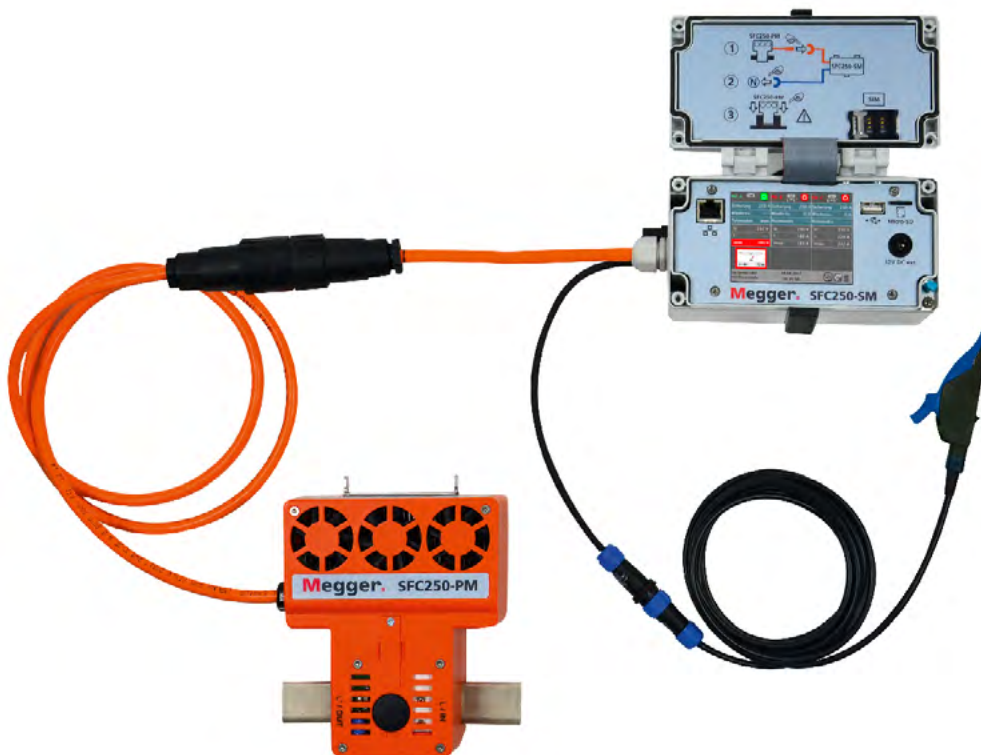

SmartFuse250

The all-in-one solution for low voltage grids

Is it possible to know in advance when a power failure will happen?

Can you reduce outage times to a minimum?

And:

can you locate cable faults at all without disconnecting the consumer from the mains??

YES, Megger can.

And so can you –

with **SmartFuse250** (SFC250).

SFC250, a **multifunctional electronic circuit-breaker system** for load currents up to 250 A is Megger's solution for low voltage power grids.



The SFC250 circuit-breaker system:

- replaces conventional HRC standard fuses and is compatible with NH02 and NH03 fuse holders
- offers the maximum flexibility through modular multipolar design
- monitors the current and voltage progression in real time, continuously records the data and reports events via the mobile phone network (GSM, 3G), WiFi or LAN to the user
- sends the user an early warning if grid overload is threatened
- can be configured to automatically restore the power
- can locate cable faults without the need to disconnect consumers from the mains



Ziement freihalten!

Megger - Streifen

Megger - Streifen

SFC250

Monitoring and fault analysis

The SFC250 consists of up to three **power modules** and one **control module** and is so compact that the distribution cabinet can be closed after installation. Safety circuits are not necessary.

After setting the desired parameters (circuit breaker rating, power restoration sequences, etc.), SFC250 independently and fully automatically takes care of all other tasks:

- The system registers and logs the current strength, the voltage and records all detected faults on the integrated 16 GB SD card.
- Fault events and their frequency are reported by text message or e-mail to the user, who can then identify whether there is a cable fault or whether grid overloads are causing the circuit-breakers to trip.
- No additional server is required.

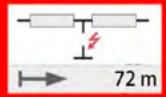
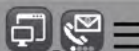
PM-A	PM-B	PM-C
Sicherung 250 A	Sicherung 250 A	Sicherung 250 A
Wiederzu. ---	Wiederzu. 0/6	Wiederzu. 0/6
Pulsmodus auto.	Pulsmodus ---	Pulsmodus ---
U: 232 V	U: 230 V	U: 230 V
I: ---	I: 180 A	I: 229 A
Ipeak 1882 A	I _{max} 183 A	I _{max} 242 A
		
SW Version 1.832 KVS Blumenstraße	29.08.2017 16:35:50	

Event-Protokoll	
14:33:47	PM A: Aus, auto., Ipeak = 290 A
14:33:47	PM A: Ein, man., 204 A
14:33:19	PM A: Fehlerortung, 61 m, Ipeak = 277 A
14:33:19	PM A: Aus, auto., Ipeak = 287 A
14:33:18	PM A: Ein, man., 204 A
14:29:57	PM A: Fehlerortung, 58 m, Ipeak = 280 A
14:29:57	PM A: Aus, auto., Ipeak = 291 A
14:29:57	PM A: Ein, man., 204 A
14:27:45	SM: SFC250 Start
< 2017-08-11 >	



JEAN MULLER LTD
CE

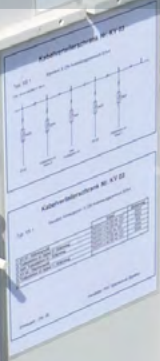

Megger
SF650K

Megger SF6700-5M

Gefahr!

Gefahr!

Gefahr!

JEAN MULLER

JEAN MULLER

JEAN MULLER

JEAN MULLER

3M Scotchlite
Reflective Material

Early warning and automatic restoration of power supply

Early warning

If there is an impending grid overload (e.g. due to increased feed-in from renewable energy sources), conventional fuses blow, which causes grid subsections to go down.

In such cases, the engineer has to attend the site to replace the fuse at the location concerned. And as soon as another overload occurs, the fuse blows again and the engineer has to head back to the site of the fault again.

Such expenditure of time and money can be avoided if the SFC250 is employed as an early warning system.

If the current load reaches a level of, say, 75% of the maximum level, the user automatically receives a warning message. And that means the grid operator has enough time to initiate appropriate measures to avert the threat of a power outage.

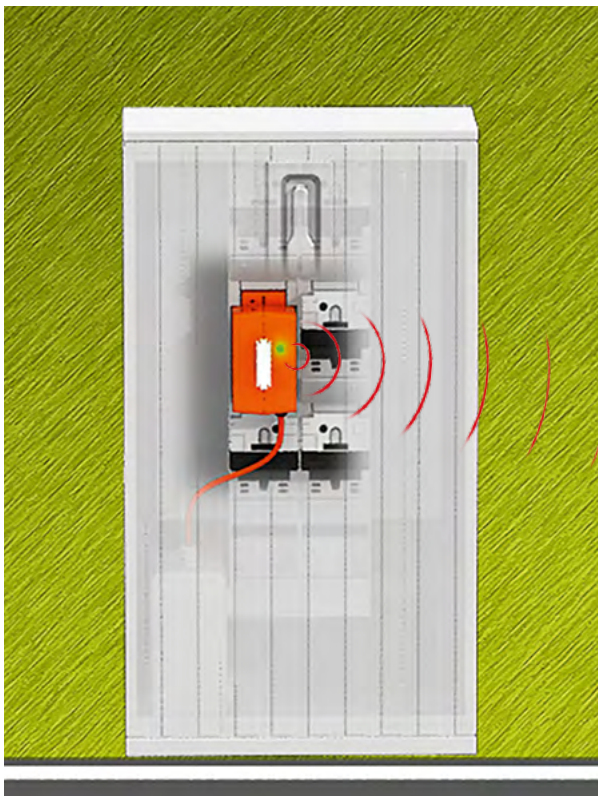

Automatic restoration of power supply

Intermittent faults can often be a source of despair for grid operators and testing engineers. Fuses randomly blow at different times and entire residential areas are left without power. The engineers constantly have to attend the site to replace the fuse before the process of locating the fault can start.

Using SFC250 does away with the need for such unnecessary trips to the fault location. The intelligent circuit-breaker system is designed so that it automatically resets according to the defined configuration and so makes fuse replacement superfluous.

And another advantage: Automatic restoration of the power supply substantially reduces outage times.

The configuration can be specified as required using a range of options:

- Time to reset:
1 to 120 seconds
- Number of reset attempts:
0 to unlimited
- Load current: 10 A to 250 A
- Messaging: E-mail and/or SMS text

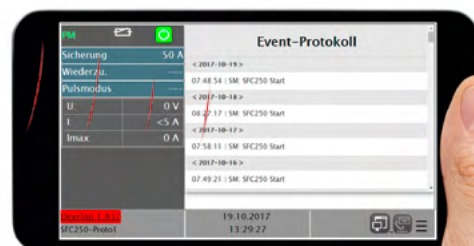

Fault location while households remain connected – SmartFuse makes it possible

Prelocation

While conventional **fault location** in high-voltage grids can only take place once the households have been disconnected from the mains, **SmartFuse250** makes it possible to find cable faults in Low-voltage grids with the aid of an internal fault-location algorithm or an additional connected reflectometer **without cutting off the supply to consumers**. The benefits for the user are clear to see:

- Time-consuming and cost-intensive searching for the connected consumers is no longer necessary.
- Digging up cables to disconnect buildings is dispensed with.
- Excavations are not required until the location of the fault has been found.

Pinpointing

SFC250 offers a number of possibilities for pinpointing in conjunction with other devices.

Pinpointing with surge wave receivers:

Once the SFC250 causes the fault to flash over using the power available in the grid, the fault location can be precisely pinpointed with the aid of a surge wave receiver (e.g. **digiPHONE+**). The multipolar system can simultaneously apply voltage on all conductors.

Sheath fault location using gas sensor

The SFC250 induces burn-off of the insulation at the fault location by repeated reconnection. The gases thus produced can be precisely pinpointed with the aid of a **fault sniffer system**.

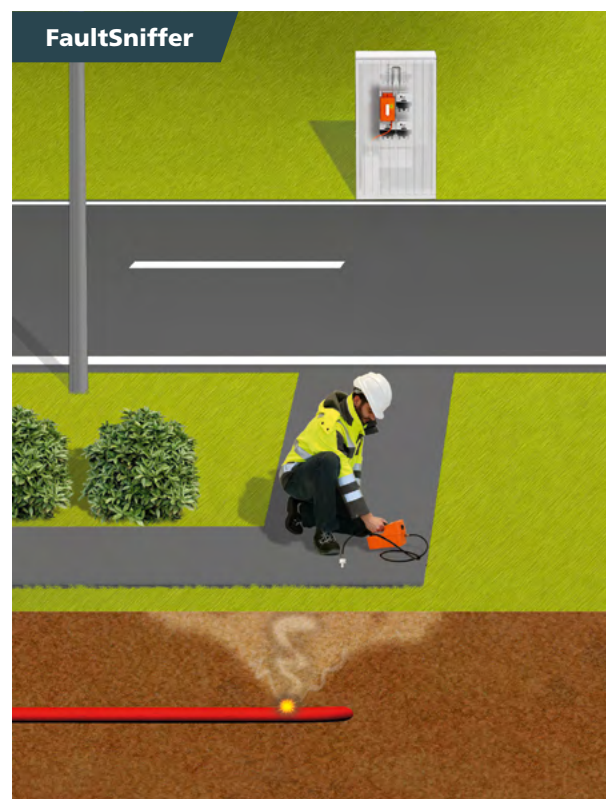

Connection diagram

Setup for a 3-phase system

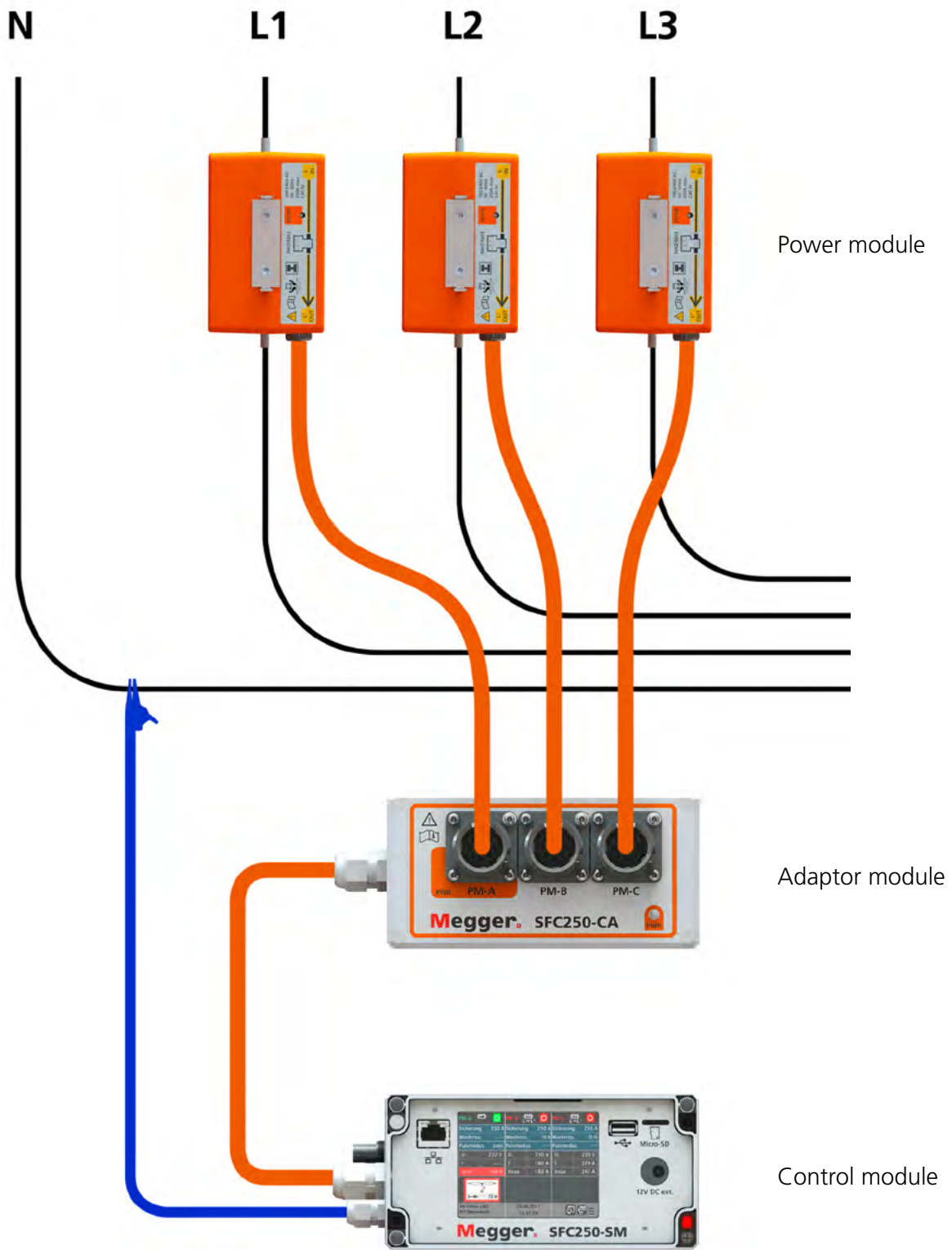

SFC250 – Technical data

General	
Triggering threshold	10 A to 250 A
Restart attempts	0 - unlimited
Waiting time until restart	1 - 120 seconds
Surge energy control	1 - 4 half-waves
Phase angle control in the event of surges	Can be set
Operating and storage conditions:	
Operating temperature	-20 °C to +50 °C
Operating humidity	50% at +40 °C, 90% at +20 °C
Storage temperature	-25 °C ... +70 °C
Memory for mains failure	Non-volatile event memory
Supply voltage for power and control module	Directly via power module 100 V ... 240 V, 50 Hz/60 Hz
Power consumption	20 VA + 1 W/A load current
Overvoltage category	to EN 60664: CAT IV 300 V
Power module	
Load current	max. 250 A continuous current
Short-circuit/surge current	max. 9000 A
Internal fuses	Load circuit: 800 A HC-type; internal supply: 1.25 A F
Cut-out capacity	200 kA
Display	LED for indicating the switching status
Housing dimensions (L x W x H)	130 x 155 x 82 mm (excluding grip lugs)
Weight	3.0 kg
Protection rating	IP 20
Compatibility	Fuse holder NH02 or NH03
Control module	
Control system	Colour touch-screen
Memory	Micro SD card, 16 GB
Display	Illuminated touch Display LED for indicating the operating status (when the cover is closed)
Interface	- GSM/UMTS modem (SIM card required) - Integrated GPS receiver (external optional) - USB 2.0 - WLAN/LAN - Wireless module (remote control activation)
Dimensions (L x W x H)	160 x 103 x 97 mm
Weight	900 g
Protection rating	IP 42
Connections	- Neutral conductor connection - External trigger output - Connection coupling to the power module
Adaptor module	
Protection rating	IP 42
Dimensions (L x W x H)	160 x 80 x 90 mm
Weight (with batteries)	450 g
Remote control	
Power supply	2 alkaline batteries, 1.5 V/LR 6 (AA)
Protection rating	IP 40
Dimensions (L x W x H)	140 x 63 x 30 mm
Weight (with batteries)	150 g

SFC250 – Ordering information



Basic set 1-phase

1 Control module
1 Power module



Extension kit 2-phase

1 Power module
1 Adaptor module



Extension kit 3-phase

2 Power modules
1 Adaptor module

Ordering information

Product	Order number
Smart Fuse 250 1-phase set (without fault location function)	1006509
<i>includes</i>	
- Control module	
- Power module	
- Remote control	
- Neutral conductor connecting lead	
- External power supply (EU plug) (for optional configuration of the device in the office)	
- Carry case	
- Fuse 1.25 A (set of 10)	
Extension kit 2-phase (1 power module, 1 adaptor module)	xxx
Extension kit 3-phase (2 power modules, 1 adaptor module)	xxx
Power module (single)	1005787
Adaptor module (single)	1009649
<i>Optional</i>	
Fault location function	90015840
Handheld control (tablet for remote control)	1008357
Fork Adaptor NH2/NH3 (for fuse holder width < 82 mm)	2009960
External GPS receiver	2007960
Spares	
Backup fuse 800 A	90007524



GERMANY

Megger · Dr.-Herbert-Iann-Str. 6 · D-96148 Baunach
Tel. +49 (0) 95 44 680 · Fax +49 (0) 95 44 - 22 73
team.international@megger.com

UNITED KINGDOM

Megger Limited · Archcliffe Road · Dover CT17 9EN
Tel. +44 (0) 1304 502 101
uksales@megger.com