

Current transformer testing

This application note gives examples on how to perform some typical tests on current transformers (CTs) with SVERKER 900. These tests are common to perform for instance during commissioning.



Important

Read and comply with the safety instructions in the User's manual.

Test procedures

Tests to be done at commissioning

- Wiring check and visual inspection
- Polarity test with DC current or AC voltage
- Burden impedance test
- Magnetization curve test
- Primary injection test with load connected

Other tests

- Secondary resistance test (RCT)
- Primary injection - Ratio test with AC current or voltage (no load connected)

Required equipment for testing

- SVERKER 900



Wiring check and visual inspection

- 1] Check that the primary and secondary side are connected for correct ratio according to system requirements.
- 2] Check the tightness for secondary connections, including grounding and shorting links.
- 3] Check that each core is connected to correct load according to drawings.
- 4] Check that each core are grounded in only one point on secondary side and close to CT location. For CT secondaries connected together the grounding shall be done at relay point, for example cores connected to differential protection.

Current transformer data

CURRENT TRANSFORMER		Type	I	69/115
Ser. N°	921410	Year	2003	OA, WO 300825
U _{in}	69/115 kV	I _{in}	40 kA 1 sec	f 60 Hz
U _{out}	230 / 550 kV	I _{syn}	100 kA	Weight 350 kg
Prim. A	P1 - P2 2000			
Ratio	151-153 151-152 251-253 251-252 351-353 351-352 451-452			
VA	1000/5 500/5 1000/5 800/5 1000/5 500/5 2000/5			
cl	50 50 50 50 50 50 50			
n	20 20 20 20 0.3 B 0.3 B 10 P			
U _{iso} (V)	≥ 20 ≥ 30 ≥ 40 ≥ 40 ≥ 5 ≥ 5			
R _{sc} (Ω)		≥ 400		

Relay core	5P and 10P
Measuring core	0.3 B
n	Accuracy limit factor (ALF) for relay cores
	Safety factor (SF) for measuring cores

Current transformer testing

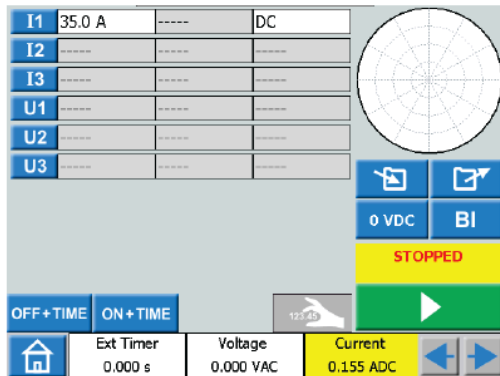

7] Reverse connection on P1 and P2 and check that the value is negative for current.

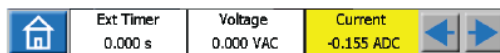

8] Repeat test for all phases and cores.

Note Only make one test for each direction at a time.

Test values including hold values are saved individually in a test file. See "Test file management" in the User's manual.

Secondary resistance test (RCT)



Secondary resistance test is made to verify continuity and the value is used for calculating knee-point.

1] Connect according to picture below.

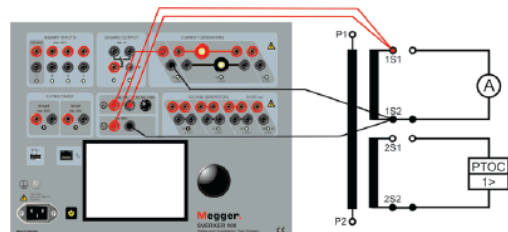

2] Set current to be generated into secondary side of CT. A recommended value is 10% of I_n (1 A or 5 A).

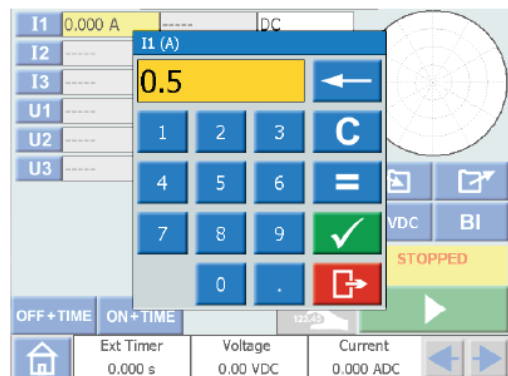

3] Set the VAM-meter for "DC" voltage measuring and activate the "Hold on stop" function.

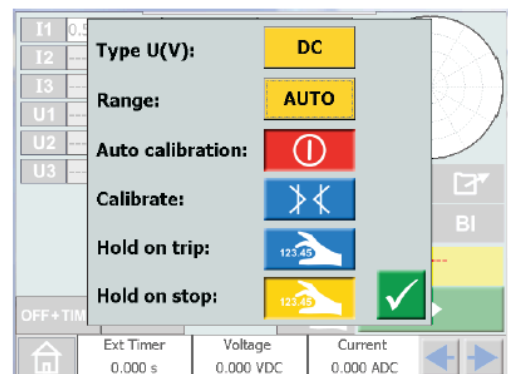

4] Make the same for current, see "Polarity test with DC current".

Current transformer testing

- 5] Inject current until stabilized value is obtained on voltage and current meters.

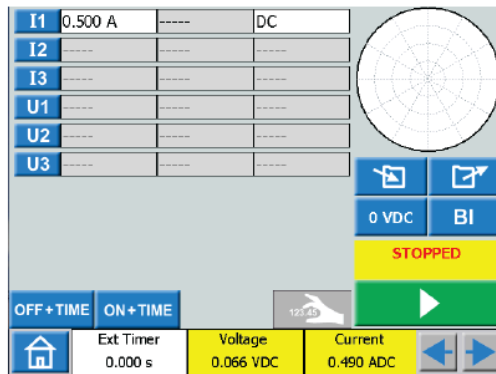

- 6] Read the result and calculate the resistance value.
- 7] Repeat test for all phases and cores.

Test values including hold values are saved individually in a test file. See "Test file management" in the User manual.

Note *If no magnetization curve is to be verified always make a short AC injection manually. See "Demagnetization" on page 7*

Magnetization curve test



A magnetization curve test is made to confirm the magnetization characteristics of a CT.

This test shall be conducted before ratio test and after secondary resistance and polarity test, since residual magnetism left in the core after DC test (polarity, resistance) otherwise gives error in the ratio test.

- 1] Calculate the knee-point level along with the formulas:

Protection core	$V_{slv} = I_s * ALF (R_{ct} + (VA/I_s^2))$
Measuring core	$V_{slv} = I_s * FS (R_{ct} + (VA/I_s^2))$

Where:

I_s	Rated secondary current
R_{ct}	CT secondary resistance
VA	Rated CT burden
ALF	Accuracy Limit Factor
F_s	Safety factor

- 2] Select configuration, parallel or series, of U-gen depending on calculated knee point level.
- 3] Connect as shown below when starting CT-magnetization instrument.
The primary of the CT should be open during test.

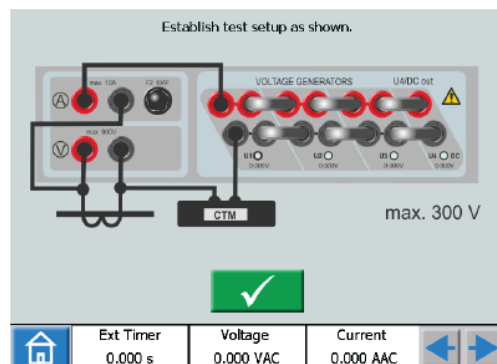

Current transformer testing

Magnetization test

The magnetization test can be made manual or in auto mode.

Manual test

- 1] Press and turn the knob according to arrow symbol. Continue until arrow change direction.

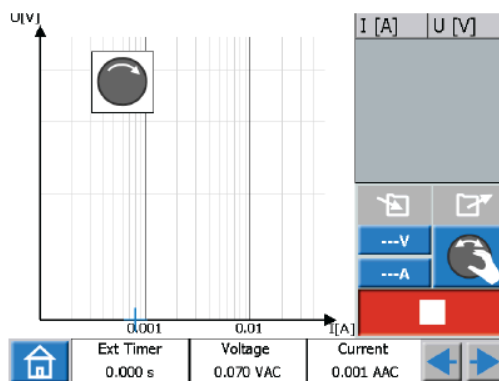

- 2] Now turn the knob anticlockwise (at approximately the same speed as you increased) to start decreasing the voltage down to zero.

Tip *Points can be plotted by pressing the knob.*

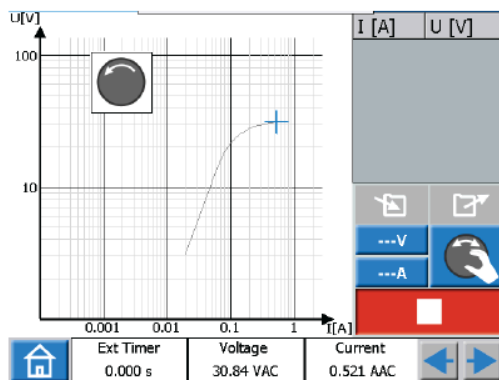

Automatic mode

- 1] Press the knob symbol to change to auto.
- 2] Press and the curve will be automatically plotted.
- 3] Repeat test for all phases and cores.

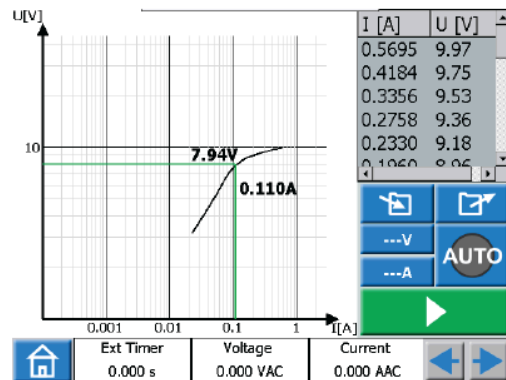

A voltage and current limit can be set , . This can be useful in:

- A] Manual mode to prevent too high injection.
- B] Automatic mode if a higher end value (A) is wanted.

Current transformer testing

Polarity test with AC voltage



Polarity test

1] Connect according to picture below.

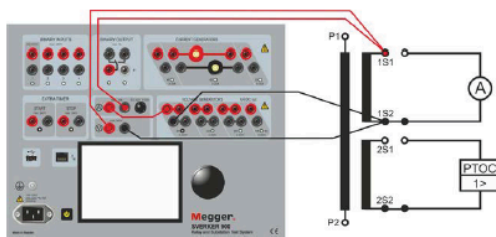

With this connection the angle between voltage and current for secondary side are measured. (see picture below)

2] Set voltage and current for VAM-meter to "Hold on stop".

3] Press twice to display angle value.

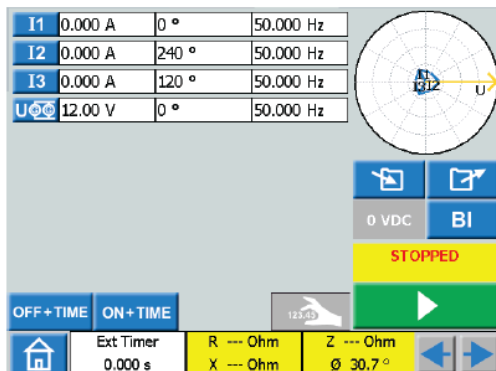

4] Press to start the test.

5] Press on voltage parameter. When it turns yellow, slowly turn knob clockwise to increase voltage.

6] Generate 50% of knee-point voltage, Wait for angle to stabilize and then press .

7] Note the angle value to compare with next test.

Note *After interrupted magnetization always do a demagnetization and shortly ground primary and secondary side of CT.*

8] Make the same test for the connection below, the VAM-meter should show the same value.

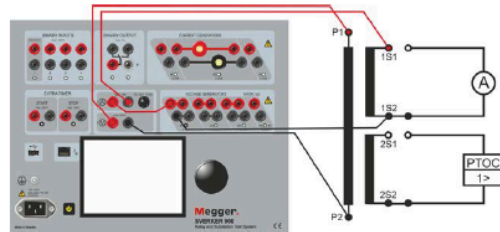

9] Change connection on CT secondary side, see below.

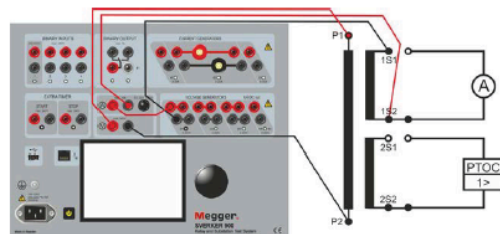

10] Make the same test and check that the angle has changed with 180 degree.

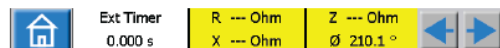

Ratio test with AC voltage

1] In same test connection as above, press twice and read the voltage value.

For voltage injection on CT,s the ratio is inverted $S/P=R$.

In this case $S=12V$, $P=1,2V$, $R=10$

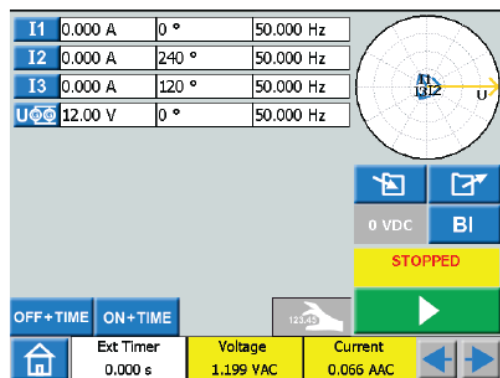

Current transformer testing

Demagnetization

- 1] Connect according to picture below.

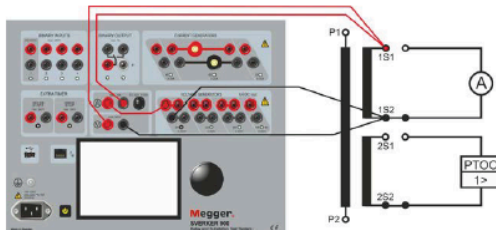

- 2] Press to start the test.
- 3] Press on voltage parameter. When it turns yellow, slowly turn knob clockwise to increase voltage.
- 4] Generate up to knee-point voltage and then slowly turn knob anticlockwise down to zero.

Burden impedance test



A burden test is made to ensure that the load (VA) is not more than specified on nameplate.

- 1] Connect according to picture below.

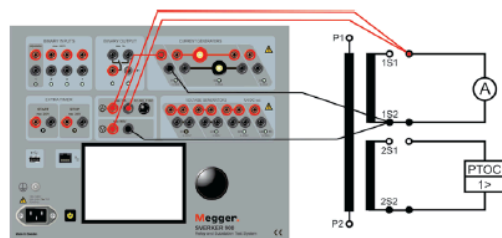

- 2] Inject current into the burden loop. A recommended value is 100% of I_n (1 A or 5 A).

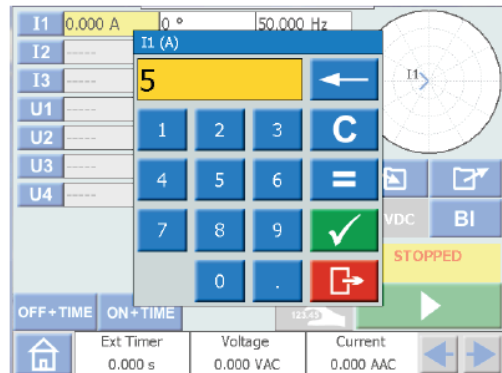

- 3] Set the VAM-meter for "AC" voltage measuring and activate the "Hold on stop" function.

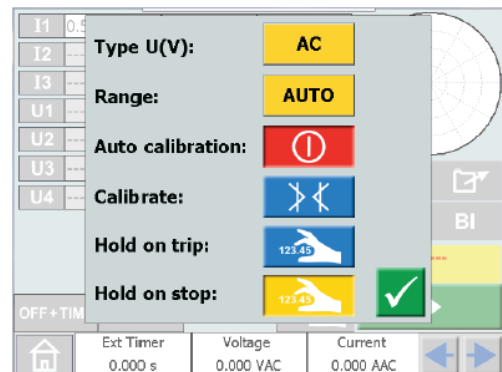

- 4] Make the same for current.

Current transformer testing

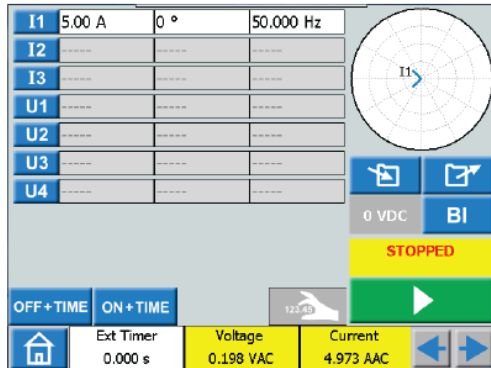

- 5] Inject current until stabilized value is obtained on voltage and current meters.
- 6] Repeat test for all phases and cores.

Test values including hold values are saved individually in a test file. See "Test file management" in the User manual.

Note *High impedance relays shall be shorted during the burden impedance test*

- 7] To see values for R, X and Z press two times on right arrow.

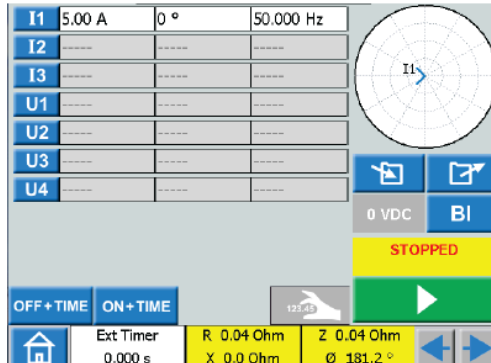

Ratio test - Primary injection no load connected



This test is to verify the turns ratio of the CT.

- 1] Make connections as shown in figure below.

Note *CT-cores not included in test should be shorted.*

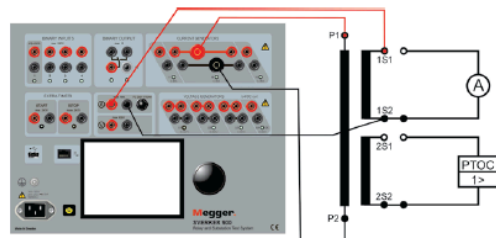

- 2] Select I-gen for parallel configuration.

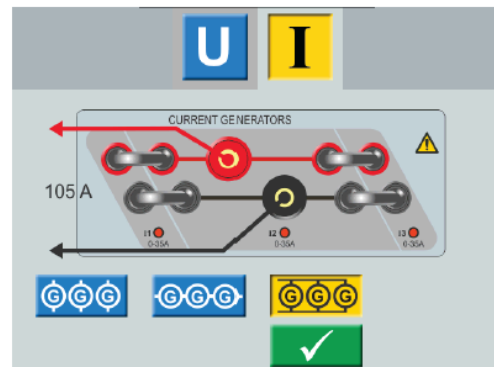

- 3] Set the current in VAM-meter for "AC" and press for "Hold on stop".

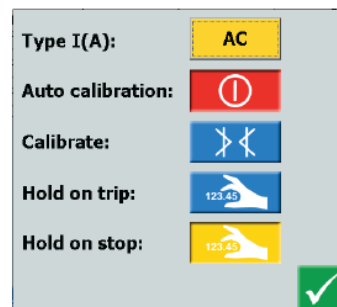

- 4] Inject on primary side of CT a current of minimum 10% of the rated primary current.

Current transformer testing

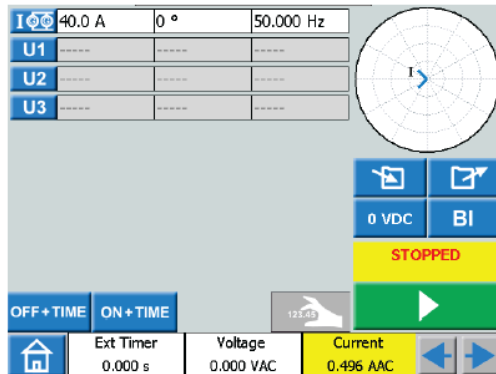

Primary injection test – with load connected



This test is to ensure the CT circuits are properly connected with respected cores and there is no mix up in the circuit (phase identification). The ratio test can also be done here.

Note *High impedance relays shall be shorted during the primary injection test.*

- 5] Check that the obtained turns ratio match with rated on the nameplate.
- 6] Repeat test for all phases and cores.

- 1] Check that all links are closed in secondary circuits for all cores included in test.
- 2] Single point grounding shall be verified for CT circuits, before starting this test.
- 3] Start injection, between L2 phase and earth, at zero current and slowly increase current. Measure in phase L2 for all cores that current is floating and then continue to 10% of rated primary current.

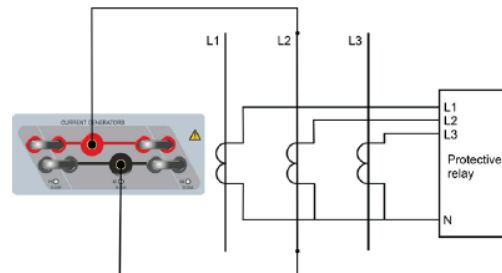

- 4] Measure secondary current at all points of CT circuits (protections and measuring devices).
- 5] Repeat test for connection L1-L2 and L2-L3, see figures below.

Note *Secondary current should only be observed at respective phase and neutral leads during phase to earth injection.
Secondary current should only be observed at respective phases and no current on neutral during phase to phase injection.*

Current transformer testing

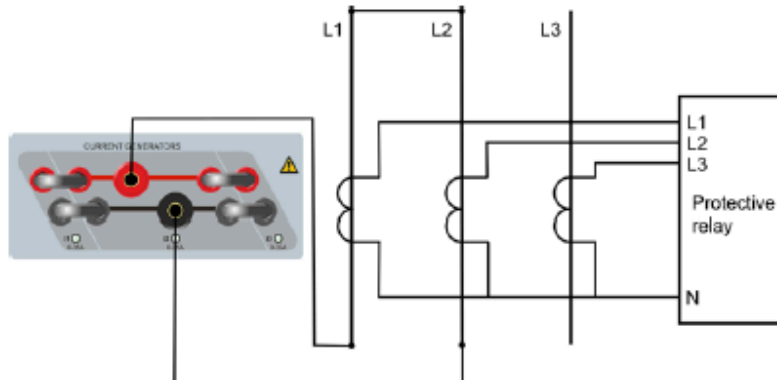

Connection L1-L2

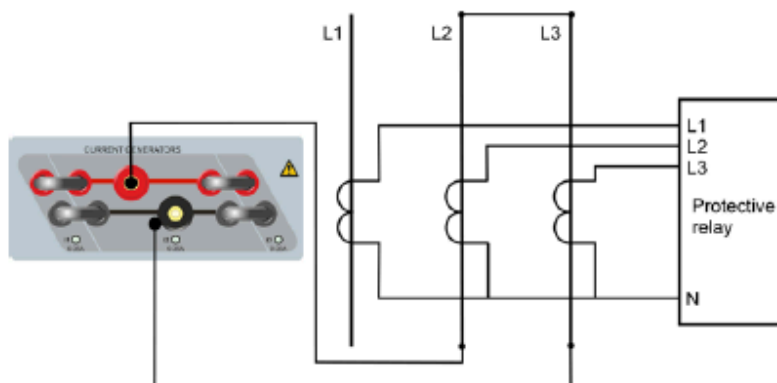

Connection L2-L3

Core identification

When one CT has several cores used for different purposes the cores can be identified during primary injection test.

- 1] Inject 10% of rated primary current between phase to earth (ground) with all burdens connected.
- 2] Short one of the cores at the CT terminal.
- 3] Check that the current to the connected load has been considerable lower or zero.
- 4] Make the same verification for the other cores.