

Megger [□] **The Measure of Excellence in Electrical Testing...**

The industry leader since 1895, Megger offers a comprehensive line of electrical test and measurement products, from portable instruments for use in the field to fully-integrated systems for high voltage systems testing. Megger fulfills a range of requirements found in electric utility, large industrial, electrical apparatus manufacturing, military and governmental applications worldwide.

PORTABLE FIELD TEST EQUIPMENT

Megger's extensive product line includes its well known portable field test equipment, including the Megger® family of Insulation Resistance testers, which indicate the deterioration of electrical insulation; Ground Resistance Testers for installing and maintaining grounding systems; and equipment for locating faults in both power and communications cable.

PRECISION TEST & MEASUREMENT EQUIPMENT

Megger operates a calibration lab traceable to the NIST to insure the quality of its precision products, which includes the DRLO® line of digital low resistance ohmmeters.

HIGH VOLTAGE SYSTEMS TEST EQUIPMENT

Megger is a leading supplier of equipment and systems for High Voltage Systems testing applications, from rigorous QC testing of manufactured power cable to demanding R&D requirements in the Aerospace industry. This range of products includes fully-integrated systems for detecting minute levels of partial discharge to HV power supplies and DC dielectric, transformer turn ratio and capacitance/dissipation factor test sets for use in the field testing of large power apparatus.

No matter whether it's a hand-held Megger® Insulation Tester or a 750kV Partial Discharge Detection Systems, Megger backs it up with a full range of support services:

Application Assistance

Our Application Engineers can demonstrate how Megger can fulfill your testing requirements.

Customer Service

Contact one of Megger's Customer Service Representatives for quick answers to your questions regarding where to buy, order entry, delivery or warranty and repair information. They can also assist you in ordering replacement parts, accessories, operating/service manuals and product/application literature.

Worldwide Network of Authorized Stocking Distributors

Many of our products are readily available through an Authorized Stocking Distributor near you.

AND MORE...

Megger also supports you with expert calibration services traceable to the NIST, full one-year warranty, convenient leasing and much more. Because when you buy Megger, you're getting more than a quality product.

To speak to a Megger Customer Service Representative or for information about any of Megger's products and services, contact us at:

Megger 

Megger
P.O. Box 9007
Valley Forge, PA 19485-1007
1-800-723-2861 ext. 8578
610-676-8578

Shipping Address:
Valley Forge Corporate Center
2621 Van Buren Avenue
Norristown, PA 19403

**Instruction Manual
for
Detex[®] Voltage Detectors and Phasing Testers**

**Catalog Numbers 514242, 514360, 514440,
514500, 510836 Series and Accessories**

**High-Voltage Equipment
Read the entire manual before operating.**

**Aparato de Alto Voltaje
Antes de operar este producto lea este manual enteramente.**

Copyright 2001 by Megger. All rights reserved.

The information presented in this manual is believed to be adequate for the intended use of the product. If the product or its individual instruments are used for purposes other than those specified herein, confirmation of their validity and suitability must be obtained from Megger. Specifications are subject to change without notice.

Megger □

Megger
Valley Forge Corporate Center
P.O. Box 9007
Valley Forge, PA 19485-1007
Tel.: 610-676-8500
Fax: 610-676-8610
www.megger.com

TABLE OF CONTENTS

Section 1 Introduction	1
<i>RECEIVING INSTRUCTIONS</i>	1
<i>GENERAL INFORMATION</i>	1
Section 2 Safety	3
Section 3 Equipment Tabulation and Specifications.....	7
<i>VOLTAGE DETECTORS</i>	7
<i>PHASING TESTERS</i>	7
<i>ACCESSORIES</i>	8
Section 4 Description and Operation of the Detex® Voltage Detectors	9
<i>PRECAUTION</i>	9
<i>ELECTRONIC VOLTAGE DETECTORS</i>	9
<i>LED VOLTAGE DETECTOR</i>	11
<i>OPERATING CONDITIONS</i>	13
Section 5 Description and Operation of the Detex® Phasing Testers	15
<i>PRECAUTION</i>	15
<i>ANALOG-TYPE KILOVOLT PHASING TESTERS</i>	15
<i>LED PHASING TESTER</i>	20
Section 6 Description and Operation of the Piezo Verifier	25
<i>DESCRIPTION</i>	25
<i>OPERATION</i>	25
Section 7 Troubleshooting and Repair	27
<i>TROUBLESHOOTING</i>	27
<i>REPAIR</i>	30
<i>PREPARATION FOR SHIPMENT AND STORAGE</i>	30
Section 8 Technical Data on Phasing Testers	31
<i>Test 1 RESISTOR ELEMENT (REMOVABLE ROD)</i>	31
<i>Test 2 INSULATION OF THE CONNECTING CABLE</i>	32
<i>Test 3 POLE INSULATION</i>	33
<i>Test 4 OPERATING CURRENT</i>	33
<i>Test 5 MAXIMUM FAULT CURRENT CALCULATIONS</i>	34
<i>Test 6 VOLTAGE-ADJUSTING KNOB</i>	34
WARRANTY	37

List of Illustrations

Figure 1	Dextex® Electronic Voltage Detectors.....	10
Figure 2	Dextex® LED Voltage Detector	11
Figure 3	Dextex® Analog-Type Kilovolt Phasing Tester.....	16
Figure 4	Dextex® LED Phasing Tester.....	20
Figure 5	Using the Piezo Verifier to Check LED Detector.....	26
Figure 6	Using the Piezo Verifier to Check LED Phasing Tester ...	26
Figure 7	Test Setup Using Ohmmeter.....	31
Figure 8	Connecting Cable Insulation Test Setup.....	32
Figure 9	Pole Insulation Test Setup.....	33
Figure 10	Operating Current Test Setup	33
Figure 11	Conditions for Maximum Fault Current.....	34

Section 1

Introduction

RECEIVING INSTRUCTIONS

Check the equipment received against the packing list to ensure that all materials are present. Notify Megger of any shortage. Telephone 1-800-723-2861 or 610-676-8578.

Examine the instrument for damage received in transit. If any damage is discovered, file a claim with the carrier at once and notify Megger or its nearest authorized sales representative, giving a detailed description of the damage.

Detex® Voltage Detectors and Phasing Testers have been thoroughly tested and inspected to rigid specifications before being shipped and are ready for use upon receipt. Batteries are not installed prior to shipment in the electronic voltage detectors and in the analog-type kilovolt phasing testers. Refer to Section 7 of this manual for battery installation instructions.

GENERAL INFORMATION

This manual describes Detex® Voltage Detectors and Phasing Testers. The detectors and testers are contact-type devices which indicate the presence of phase-to-ground voltages. Refer to Section 2 of this manual for safety information.

Specifications for the various instruments are delineated in Section 3. Section 4 describes the operation of the detectors and Section 5 describes the operation of the testers. The use of the Piezo Verifier, an accessory for verifying the correct operation of detectors and testers that do not have a self-testing capability, is described in Section 6. Section 7 contains simplified troubleshooting procedures including instructions for battery installation. Refer to Section 8 for additional technical data on phasing testers.

Megger 

Section 2 Safety

Safety is the responsibility of the user.

The purpose of the detectors and testers is limited to use as described in this manual. Do not use the detectors or testers with any device other than specifically described.

The following warning and caution notices are used in this manual where applicable. These notices precede the specific instruction where the hazard is likely to be encountered.

WARNING

Warning, as used in this manual, is defined as a condition or practice which could result in personal injury or loss of life.

CAUTION

Caution, as used in this manual, is defined as a condition or practice which could result in damage to or destruction of the equipment or apparatus under test.

- Use with extreme care. If in doubt, stop.
- Check detectors and testers for correct operation before and after use.
- Ground the circuit under test before working on it.
- These detectors and testers should be used only by personnel familiar with safe methods of approach to live equipment and conversant with safety precautions in performing live line operations.
- Follow all applicable safety rules.

These voltage detectors and phasing testers are intended to be connected to sources of high-voltage electrical energy and all persons making or assisting in the tests must use all practical safety precautions to prevent contact with energized parts of the test equipment and related circuits. If the detectors and testers are operated properly, test personnel need not wear rubber gloves. As a routine safety procedure, however, some users require that

rubber gloves be worn when making connections to high-voltage equipment. Megger considers this an excellent safety practice.

Users of high-voltage equipment should note that high-voltage discharges and other sources of strong electric or magnetic field may interfere with the proper functioning of heart pacemakers. Personnel with heart pacemakers should obtain expert advice on the possible risks before operating this equipment or being close to the equipment during operation.

Attention is drawn to the safety warnings marked on the body of the detectors. In particular, the detectors must be held below the line marking the safe limit for handling when applying to live apparatus, telescopic pole models extended correctly, and detector head models must be attached to a hot line pole, as required by the voltage of the apparatus under test.

WARNING

The test equipment must be held on the power line for a minimum of 3 seconds.

The detectors and testers are contact devices; they are not proximity devices. Therefore, their fork or hook terminals must actually touch the bare conductor being tested for *at least 3 seconds* to work properly.

Voltage detectors are designed to operate only on systems referenced to ground. Erroneous indications will occur when testing ungrounded delta or wye systems. Correct indications by the instruments depend on their being used with the correct system.

Cat. No. 514360-2, 514360-3, 514360-4, 514242-1, 514242-2, 514500-3, 514500-4 instruments (those supplied without integral poles) are showerproof. They are not waterproof and could be rendered inoperative if immersed. When using these detectors and testers in rain or snow, care must be taken to follow all safety precautions as suggested by the manufacturer of the hot line pole being used. In particular, make sure that the hot line pole used has a wet rating at least equal to the voltage of the system under test. Also make sure that it is clean and free from imperfections, such as cracks and chips.

Cat. No. 514440-2, 514360-1, 514500-1, 514500-2, and 510836-1 instruments (those supplied with integral poles) should not be used in rain or snow. They do not have a wet rating.

When checking for the absence of voltage, detectors and testers should be tested both before and after use to make sure they are operating properly. It is best to make this test on a live portion of the same circuit being tested. This will ensure that the sensitivity of the detector is satisfactory for the particular application. As an alternative, make the tests on another circuit of similar rating and in similar lighting conditions.

Before touching or working near de-energized circuits or apparatus, make sure that they are grounded using appropriate safe grounding techniques. Conductors and cables used for grounding must be capable of handling the maximum possible current.

Make sure that the nominal voltage of the apparatus under test is within the voltage range specified on the instrument.

NOTE

The voltage specified on voltage detectors refers to nominal system line voltage. The actual operating voltage range of the detector is the voltage specified, divided by 1.73.

Megger 

Section 3

Equipment Tabulation and Specifications

VOLTAGE DETECTORS

(For ac use only, grounded circuits only)

Cat. No	Type	Operating Range (kV) ph-ph	Style	Weight lb (kg)
514242-1	Electronic	69 to 230	Spline Fitting	1.5 (0.67)
514242-2	Electronic	230 to 500	Spline Fitting	1.5 (0.67)
514360-1	Electronic	2.4 to 6.9	Telescopic Pole 34 to 51 in. (86 to 129 cm)	2.2 (0.99)
514360-2	Electronic	4.16 to 13.8	Spline Fitting	1.1 (0.50)
514360-3	Electronic	12 to 34.5	Spline Fitting	1.1 (0.50)
514360-4	Electronic	24.9 to 69	Spline Fitting	1.1 (0.50)
514440-2	LED	4.16 to 34.5	Telescopic Pole 34 to 49.5 in. (86 to 126 cm)	2.1 (0.95)

Detectors are supplied with vinyl carrying cases.

PHASING TESTERS

(For ac use only, grounded or ungrounded circuits)

Cat. No	Type	Operating Range (kV)	Style	Weight lb (kg)
514500-1	Meter	1 to 7	Two Pole	4.0 (1.8)
514500-2	Meter	4 to 36	Two Pole	4.7 (2.1)
514500-3	Meter	13 to 80	Spline Fitting	4.3 (1.9)
514500-4	Meter	4 to 36	Spline Fitting	4.3 (1.9)
510836-1	LED	2.1 to 36	Two Pole	3.0 (1.4)

Testers are supplied with metal carrying cases.

ACCESSORIES

Cat. No. 512117 Pneumatic Rubber Glove Tester

Size: 5-1/2 in. (14 cm) high; 5 in. (12.7 cm) diameter

Weight: 1-1/2 lb (0.7 kg)

Cat. No. 510005 Piezo Verifier

Size: 7 in. (18 cm)

Weight: 3/4 lb (0.34 kg)

Section 4

Description and Operation of the Detex[®] Voltage Detectors

PRECAUTION

Be sure to read and understand Section 2, Safety, of this manual before operating the voltage detector. Even after determining that a circuit is de-energized by use of the detector, it may still carry an induced voltage, a capacitively coupled voltage, or an applied voltage lower than the operating range of the detector. The circuit under test must be grounded before being touched.

ELECTRONIC VOLTAGE DETECTORS

These single-pole voltage detectors are used to verify the absence of voltage in the detector's range on a line or terminal of any grounded ac electrical system. The presence of ac voltage is detected with respect to ground by making contact between the detector and the live equipment. The three-step procedure of testing the detector, testing for absence of high voltage, and testing the detector again should be strictly observed.

Cat. No. 514360 and 514242 series detectors, see Figure 1, use an electronic detection circuit powered by batteries enclosed in the assembly. The presence of voltage is indicated by an audible signal sounding and by a red light-emitting diode (LED) flashing. Absence of these signals indicates that the conductor or termination under test is free of voltage above the low voltage limit of the detector.

To activate the detector test system, briefly press the red TEST button. The audible signal sounds and the red LED flashes for a short time. The green LED lights for approximately two minutes indicating that the detector is operational and ready for use. The green LED extinguishes when the presence of voltage is detected as indicated by the audible signal sounding and by the red LED flashing. Note that the Cat. No. 514242 series detectors have four red LED's for ease of visibility.

Except for the Cat. No. 514360-1 detector, which is equipped with a telescopic pole, detectors with spline fittings must be attached to a universal

connection on the end of the proper length hot line pole rated for the voltage of the system being tested.

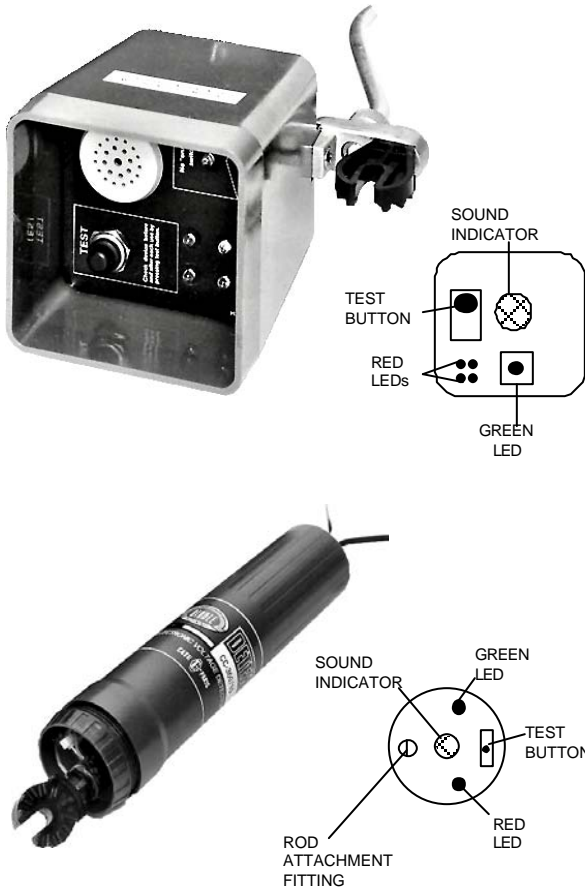

Figure 1: Detex[®] Electronic Voltage Detectors

LED VOLTAGE DETECTOR

The Cat. No. 514440-2 LED voltage detector shown in Figure 2 uses a lamp as the detecting device, with the lamp connected on one side to the contact terminal and on the other side to an external conducting electrode. A small gap is incorporated in series with the lamp. The extremely sensitive lamp is illuminated by a very small current resulting from the capacitive effect between the internal electrode and ground. This detector operates only on grounded ac systems.

The detector has a strong molded thermoplastic housing and a built-in TEST button. On recent models (identified by a green label sticker), the TEST button applies a piezo voltage to check both the lamp and the adjustment of the main spark gap. On earlier models (with a red label sticker) this test only checks the neon lamp.

Complete LED Type Detector
with Telescopic Pole



LED Type Detector Head

Figure 2: Dextex[®] LED Voltage Detector

The overall operation of the detector must be checked by at least one of the following procedures:

Press the TEST button or use an external verifier. The lamps must flash.

WARNING

The test equipment must be held on the power line for a minimum of 3 seconds.

Adjust the pole length to correspond to the system line-line voltage. Touch the forked tip on a known live conductor at the same voltage for *at least 3 seconds*. The lamps must flash.

A three-step procedure should be strictly observed when testing circuits:

1. Test the detector operation as described in the preceding paragraph.
2. Test the unknown line for absence of voltage.
3. Test the detector again as described in the preceding paragraph.

In step 2, during a routine test on grounded systems, the presence of high voltage in the detector's range causes the lamp to illuminate.

The LED detector is equipped with a telescopic pole which is marked with a series of rings graduated in kilovolts, indicating the minimum safe length required for each voltage range. These demarcations assist the user in adjusting the pole to the exact length required by operating conditions.

OPERATING CONDITIONS

WARNING

Keep your hands behind the guards on the poles. Follow all safety precautions for high-voltage equipment. Ground circuit before touching using a safe grounding method.

WARNING

The test equipment must be held on the power line for a minimum of 3 seconds.

The forked terminal must touch the bare conductor under test for proper operation of the detector for *at least 3 seconds*.

The operating parts of the detector are enclosed in an insulated and watertight assembly which protects them from external damage and the effects of humidity. If the detector gets wet, all external surfaces should be dried before normal operations are resumed.

Electronic voltage detectors with Cat. No. 514360-2, 514360-3, 514360-4, 514242-1, and 514242-2 are showerproof. They are not waterproof and could be rendered inoperative if immersed. When using the detectors in rain or snow, follow all safety precautions as directed by the manufacturer of the hot line pole being used. In particular, make sure that the hot line pole used has a wet rating at least equal to the voltage of the system under test. Also, make sure that it is clean and free from imperfections, such as cracks and chips.

Do not use the electronic voltage detector equipped with the telescopic pole (Cat. No. 514360-1) or the LED voltage detector (Cat. No. 514440-2) in rain or snow. They do not have a wet rating.

NOTE

Cat. No. 514440-2 is *not* approved for use on reactors manufactured by Trench Limited.

Megger 

Section 5

Description and Operation of the Detex[®] Phasing Testers

PRECAUTION

Be sure to read and understand Section 2, Safety, of this manual before operating the phasing tester.

ANALOG-TYPE KILOVOLT PHASING TESTERS

Description

These analog-type kilovolt phasing testers (Cat. No. 514500-1, 514500-2, 514500-3, and 514500-4) consist of two insulated poles each equipped with a removable contact antenna and a flexible insulated cable connecting the two poles. See Figure 3.

The antennas include protection resistors and must be screwed onto the pole ends before use. The antennas are not interchangeable. The detection rod and its corresponding antenna each have a red identification dot. Make sure that the antenna with the red dot is screwed onto the pole with the red dot.

NOTE

This type of phasing detector cannot be used for single pole voltage detection.



Figure 3: Detex[®] Analog – Type Kilovolt Phasing Tester

Hand guards are standard on phasing testers with Cat. No. 514500-1, and 514500-2. Cat. No. 514500-3 and 514500-4 testers have universal spline fittings for attachment to hot line poles.

These phasing testers are designed for outdoor testing of grounded and ungrounded systems. Applications for these instruments include checking high-voltage fuses, testing for correct phase connections, and testing for absence of high voltage on de-energized lines or apparatus. Note that the movement of the pointer over the calibrated scale is only an indication of the presence of voltage in the range indicated. Phasing testers are not to be used for determining the exact voltage on the line or apparatus being tested.

The accuracy of the kilovolt indication is such that the nominal system voltage shown by the indicator needle can be identified (either phase to phase or phase to ground). The bandwidth covers the approximate spread of system voltages in that range. Under most circumstances the needle will fall within the appropriate band for the system under test; however, an indication outside of the bands should not necessarily be construed as a false reading. The difference between a phase-to-phase and a phase-to-ground indication is easily discernible.

Operating Conditions - Detex[®] Analog Voltage Detectors**WARNING**

Keep your hands behind the guards on the poles.

WARNING

The test equipment must be held on the power line for a minimum of 3 seconds.

CAUTION

Phasing testers are constructed for intermittent use and should not be left operating on closed circuits beyond the time necessary for the tests, since the protective resistances may be damaged by prolonged operation.

The forked terminal must touch the bare conductor under test for proper operation of the phasing tester for at *least 3 seconds*. Cat. No. 514500-1 and 514500-2 testers should not be used in rain or snow. They do not have a wet rating.

Cat. No. 514500-3 and 514500-4 testers are showerproof. They are not waterproof and could be rendered inoperative if immersed. When using the phasing testers in rain or snow, care must be taken to follow all safety precautions as suggested by the manufacturer of the hot line pole being used. In particular, make sure that the hot line pole used has a wet rating at least equal to the voltage of the system under test. Also make sure that it is clean and free from imperfections such as cracks and chips. Follow all other appropriate safety precautions.

Check operation of the testers before and after each test on a live portion of the circuit under test. Ground circuit before touching using a safe grounding method. Operation of the Cat. No. 514500-1, 514500-2, and 514500-4 testers can be checked using the self-test system. To activate the system, touch the two contact forks together and press the test button. The meter pointer must deflect to the BATTERY TEST position. Refer to Section 7, Troubleshooting and Repair, for complete details.

Voltage Detection - Detex® Analog Voltage Detectors

WARNING

The test equipment must be held on the power line for a minimum of 3 seconds.

Touch for *at least 3 seconds* the contact forks or hooks of the detector element pole and the auxiliary element pole to two conductors or parts to be tested. The meter will respond to the voltage between the two parts. In cases where both the detector and auxiliary element poles are touching different phase conductors of grounded or ungrounded systems, the meter response will be phase-to-phase voltage. If the detector element pole is touched to a conductor and the auxiliary element pole touched to the ground bus of grounded systems, the meter responds to the phase-to-ground voltage. Phase-to-ground voltage is the result of phase-to-phase voltage divided by 1.732 (the square root of 3).

For example,

$$34,500 \text{ V phase-to-phase} / 1.732 = 19,919 \text{ V phase-to-ground.}$$

Testing Phase Connections - Detex® Analog Voltage Detectors

After having checked, by the previously described detection methods, the presence of voltage on each of the conductors of each of the two circuits, use the following method to identify conductors of the same phase.

WARNING

The test equipment must be held on the power line for a minimum of 3 seconds.

CAUTION

Do not attempt to check phasing between two circuits when either or both circuits are ungrounded systems unless both circuits originate from the same supply transformer winding. Meter indication is unpredictable.

First, touch for *at least 3 seconds* the detector element pole to one of the conductors of the first circuit. While maintaining this contact, successively touch the auxiliary element pole to each of the conductors of the second circuit. The conductor, which is at the same phase as the conductor being touched on the first circuit is identified by having no pointer response on the meter, while in the case of the two other phases the meter responds with the phase-to-phase voltage. Use this same procedure on the other conductors to identify them by pairs.

LED PHASING TESTER

Description

The Cat. No. 510836-1 LED phasing tester is designed for use on grounded and ungrounded systems. It consists of two 43 in. long poles with a flexible insulated cable connecting them. Hand guards are provided for safety. The indicator lamp is easily visible in testing situations with poor lighting. Applications include detection using one or two poles, checking high-voltage fuses, testing for correct phase connections, and testing for absence of high voltage on de-energized lines or apparatus. The LED phasing tester is shown in Figure 4.



Figure 4: Detex[®] LED Phasing Tester

Operating Conditions – LED Phasing Tester

WARNING

Keep your hands behind the guards on the poles.

WARNING

The test equipment must be held on the power line for a minimum of 3 seconds.

CAUTION

Do not attempt to check phasing between two circuits when either or both circuits are ungrounded systems unless both circuits originate from the same supply transformer winding because results are unpredictable.

Check operation of the tester before and after each test on a live portion of the circuit under test. Ground circuit before touching using a safe grounding method. The forked terminals must touch the bare conductors under test for *at least 3 seconds* for proper operation of the tester. Do not use the LED phasing tester in rain or snow.

Remember that for correct operation, when testing for the presence or absence of voltage using the single-pole technique or with the auxiliary element touching ground, the system being tested must be referenced to ground. Ungrounded delta or wye systems will give erroneous results.

Voltage-Adjusting Knob – LED Phasing Tester

The correct adjustment of the voltage-adjusting knob is essential to ensure proper operation and particularly to obtain extinction of the lamp when there is contact with two conductors of the same phase or potential. If the adjustment is made for too high a voltage, the lamp may not light. If it is adjusted to a voltage that is too low, there is a risk that it will remain lit due to the capacitance effect, even if the two connectors are at the same potential.

WARNING

The voltage-adjusting knob must not be operated during a voltage test.

Set the voltage-adjusting knob in accordance with the following:

1. For single-pole detection, with the auxiliary element held clear, set the adjusting knob at the system line to the expected ground voltage.
2. For two-pole detection:
 - a. When checking for the presence or absence of voltage with the auxiliary element touching ground, set the adjusting knob at the system line to the expected ground voltage.
 - b. When checking fuses in accordance with the procedure outlined in this section, set the adjusting knob at the system line to the expected ground voltage.
 - c. When testing phase connections in accordance with the procedure outlined in this section, set the adjusting knob at the expected system line to line voltage.

The tester is not a voltage-measuring device, it is only intended to indicate the presence or absence of voltage by methods as described in this section. The use of the voltage-adjusting knob to determine system voltage is not recommended because of the difficulty in interpreting the results.

Single-Pole Detection – LED Phasing Tester

By using the detector element alone, single-pole detection may be carried out by holding the auxiliary element clear. A definite flash rate is obtained with voltages of 3 kV and above. This use is only of limited interest and a higher flash rate is obtained by two-pole detection as well as detection on voltages down to 2 kV with the auxiliary element on the ground bus of grounded systems.

Two-Pole Detection – LED Phasing Tester

Simultaneously touch the contact pieces to the two conductors or parts to be tested. One of them may be a conductor which is connected to earth,

and in this case it is simply a matter of finding out which parts are live. Illumination is obtained for voltages from approximately 2 kV.

Checking High-Voltage Fuses – LED Phasing Tester

This operation is a typical example of the application of the phasing tester. First, while holding the auxiliary element clear, touch the detector element to the live side of each cutout; the flashing of the lamp indicates that voltage is present on the input side of the equipment. Then touch the auxiliary element on the secondary side of the fuse. The extinction of the lamp indicates that the two terminals are at the same potential and that the fuse is intact. If the lamp flashes, then the fuse is defective.

Testing Phase Connections – LED Phasing Tester

After having checked, by simple detection methods, the presence of a voltage on each of the conductors, use the following method to identify conductors of the same phase. First, while holding the auxiliary element clear, touch the detector element to one of the conductors of the first circuit. The lamp lights confirming the presence of a voltage.

While maintaining this contact, successively touch the auxiliary element to each of the conductors of the second circuit. The one which is at the same phase as the conductor being touched on the first circuit is identified because the lamp goes out, while in the case of the two other phases, there is considerable increase in the rate of flash. Use this same procedure on the other conductors to identify them by pairs.

CAUTION

Capacitive effects due to interaction with nearby grounds may give erroneous results. To avoid this, proceed as follows:

Interchange the positions of the auxiliary and display elements and retest all phases. Again, the lamp must go out for each of the same pairs that were previously identified as being in phase. If not, then the system is incorrectly hooked-up and further testing should be done using an analog-type kilovolt phasing tester (Cat. No. 514500-1 or 514500-2, as appropriate) to identify the problem.

NOTE

Since the flash rate increases as the voltage increases, different flash rates are due to the voltage levels that are present. Therefore, a careful observation of the flash rate serves as an additional check for the presence of improper voltages due to incorrect system connections.

Testing for Absence of Voltage Before Starting Work – LED Phasing Tester

Frequently, when a line is separated from the source of supply but not yet grounded there is a relatively high voltage present on the line, resulting from induction due to neighboring lines which are still live. A single-pole voltage detector used under these conditions will give a positive indication which may give the impression that the circuit has not been broken.

Using the voltage-adjusting knob on the LED phasing tester resolves this difficulty. Because there is a large difference between the normal service voltage and the induced voltage, when the tester is set to the service voltage, it will only light when the line is effectively connected to the source of supply. This check having been made, it is then possible, by adjusting the voltage-regulating switch to minimum, to find out if the circuits are live at an induced voltage (down to the threshold of sensitivity of the indicator, approximately 2000 V).

Section 6

Description and Operation of the Piezo Verifier

DESCRIPTION

The Piezo Verifier, Cat. No. 510005, consists of a piezo electric generator of very small dimensions enclosed in a case of insulating material. It is used to verify the correct operation of voltage detectors and phasing testers that do not have a self-testing capability.

On the base of the verifier is a small metal contact designed to be connected to the object under test. A socket on the side is provided for making a connection to ground or for testing a closed circuit with the test lead supplied. The mechanism is operated by squeezing the molded handle. The output is approximately 1800 V when the handle is squeezed at the prescribed rate of three times a second.

WARNING

Although the output of the verifier is not lethal, the jolt that could be received is sufficient to cause an involuntary muscle spasm. Care must be taken to avoid contact with the output terminal, particularly when working on ladders or in a situation where such a reaction could be dangerous.

It is important that the verifier be used in the same lighting conditions as those at the actual test site. A carrying case is provided for protection of the instrument and for storage of the test lead.

OPERATION

To Check LED Voltage Detectors

To check a LED voltage detector, the contact point on the verifier should be contacted either to the test terminal on the side of the detector head or to the forked tip of the detector, as shown in Figure 5. The LED voltage

detector should be held as shown and the verifier operated with the other hand.

It is extremely important to use the Piezo Verifier to check that the LED voltage detector is operating correctly if it is being used to detect the absence of voltage on a conductor, unless other means of checking are used. Refer to Section 2.

To Check LED Phasing Testers

The Detex® Phasing Tester, Cat. No. 510836-1 is checked by connecting a wire from the magneto on the verifier to the other pole of the LED phasing tester which is not in direct contact with the verifier. See Figure 6. Otherwise, the procedure is the same as that for LED voltage detectors. Before each verification, the voltage-adjustment knob of the LED phasing tester must be brought back to zero.

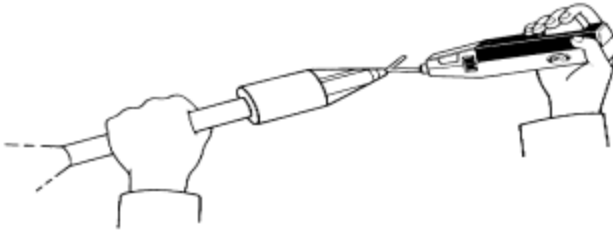

Figure 5: Using the Piezo Verifier to Check an LED Detector

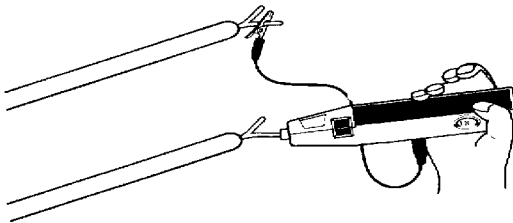

Figure 6: Using the Piezo Verifier to Check an LED Phasing Tester

Section 7

Troubleshooting and Repair

TROUBLESHOOTING

Voltage Detectors

Check operation of the voltage detector on a live portion of the same circuit under test. If there is *no* indication on the detector, check the following:

1. Using a light shield if necessary, confirm that the LED detector is *not* illuminating.

In strong daylight, it is sometimes very difficult to determine if the unit is operating properly and extra light shielding may be required or an electronic detector must be used.

2. Voltage detectors will not work properly on ungrounded circuits since they operate on the very small capacitance current running from the line under test to ground. If ungrounded circuits have to be tested, it will be necessary to use a two-pole phasing tester.
3. Make sure there is sufficient line voltage for operation. For example, the minimum operating voltage for the LED voltage detector is 2100 V to ground such as can be found on a 2400/4160 V grounded wire system. This instrument will not operate properly on a 2400 V delta system even though this system is grounded through a grounding transformer since such a system would have a phase voltage to ground considerably below 2000 V.
4. If the preceding checks have been made and the LED detector still does not illuminate properly, the LED indicator may be faulty, although this is rare. In such cases, it is recommended that the instrument be returned to the factory for repair.
5. With electronic voltage detectors, replace batteries and recheck. If the detector still does not operate properly, consult the factory.

To install batteries in electronic voltage detectors:

For Cat. No. 514242 series detectors:

1. Unscrew the black front ring of the housing.
2. Remove the body of the indicator from the housing.
3. Snap on the battery connection and place the battery in its compartment. Replace only with 9-V Duracell alkaline battery MN1604 (6LR61) because of confined space in the meter housing.
4. Reassemble the body and ring into the housing.
5. Press the TEST button to check instrument is working correctly.

For Cat. No. 514360 series detectors:

1. Remove front probe (if attached), unscrew rear retainer ring, and carefully withdraw the sensor/detector section from its housing.
2. Remove the battery holder from its compartment and install four "AA" alkaline batteries in accordance with polarity indicators.
3. Replace battery holder in its compartment.
4. Slide the sensor/detector section back into its housing being careful to align the orange color keyed tab with its mating slot on the housing. The section should settle in and the forward hex portion should seat in its recess.
5. Replace the rear retainer ring.

LED Phasing Tester

1. For illumination failure of the LED phasing tester, steps 1, 2, and 3 of the procedure for voltage detectors generally also apply when using the phasing tester in the single-pole mode of operation, keeping in mind that the threshold voltage of the detector in this mode, is 3000 V to ground. When the two-pole mode of operation is used, this threshold voltage is reduced to 2000 V and it is not necessary that the system be grounded.

2. Make sure that the adjusting knob is properly set to the voltage of the system. The indicator lamp will flash brightest when this knob is set properly so do not set to a voltage either appreciably greater or less than the circuit voltage.
3. Inspect the extension rods for good physical contact at their mating ends.
4. If the tester still does not illuminate properly, the indicator lamp is probably defective and the tester should be returned to the factory for repair.

Analog-Type Kilovolt Phasing Testers

Cat. No. 514500-1, 514500-2, and 514500-4 phasing testers are powered by a 9-V battery located in the meter housing. The total instrument can be checked in the following manner.

1. Install the antenna ends of both poles.
2. Touch the forked terminals together.
3. Press the red button at the back of the meter housing; recent models have the button on the dial side of the meter.
4. The pointer should deflect to the BATTERY TEST position. If the deflection is insufficient, replace the battery and retry. If the deflection is still not correct, consult the factory.

To install battery in analog-type kilovolt phasing testers:

1. Unscrew the front ring nut from the meter housing.
2. Remove the body of the meter from its housing.
3. Snap on the battery connection and place the battery in its compartment. Replace only with 9-V Duracell alkaline battery MN1604 (6LR61) because of confined space in the meter housing.
4. Replace the body of the meter in its housing.
5. Replace the front ring nut.

REPAIR

Megger offers a complete repair service and recommends that its customers take advantage of this service in the event of any equipment malfunction. When returning an instrument to the factory for repair, please indicate all pertinent information, including problem symptoms and attempted repairs. Equipment returned for repair must be shipped prepaid and insured and marked for the attention of the Repair Department Manager.

PREPARATION FOR SHIPMENT AND STORAGE

Remove batteries from battery powered detectors or testers before shipment or before long-term storage. Place the detector or tester in its carrying case and pack in a carton (original shipping carton if available) with adequate dunnage in accordance with best commercial practice. Seal the container with waterproof tape.

Section 8

Technical Data on Phasing Testers

This section describes factory tests and calculations. They are presented for better understanding and as an aid to users who wish to set up their own test program. Megger will assist users who require technical assistance concerning specific test methods.

TEST 1 RESISTOR ELEMENT (REMOVABLE ROD)

The following tabulation gives the values of the resistance in megohms for each phasing tester. Resistive tolerance is ± 5 percent.

Phasing Tester Cat. No.	Resistance ((MW)	
	Detector Element Pole	Auxiliary Element Pole
514500-1	3.76	2.82
514500-2	21.6	14.4
514500-3	37.7	33.8
514500-4	21.6	14.4
510836-1	25	25

Figure 7 shows the test setup for measuring the value of protection resistance of the phasing tester antenna element using an ohmmeter.

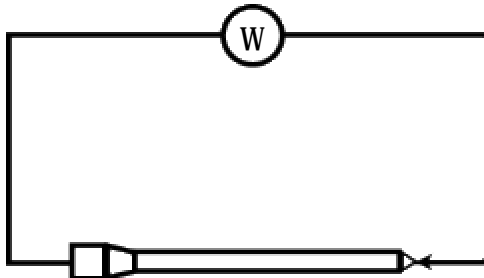

Figure 7: Test Setup Using Ohmmeter

WARNING

Tests 2, 3, and 4 involve dangerous high voltages. These tests must be set up and performed only by qualified personnel in accordance with all safety precautions.

WARNING

The test equipment must be held on the power line for a minimum of 3 seconds.

TEST 2 INSULATION OF THE CONNECTING CABLE

Figure 8 shows the test setup for testing the insulation of the connecting cable using an ac milliammeter with suitable scale. Test voltage is 1.2 times maximum nominal phase to ground voltage for 1 minute; leakage current is less than 500 μA .

For example, test voltage for the Cat. No. 514500-2 tester is:

$$\frac{36000\text{V}}{\sqrt{3}} \times 1.2 = 25000\text{V}$$

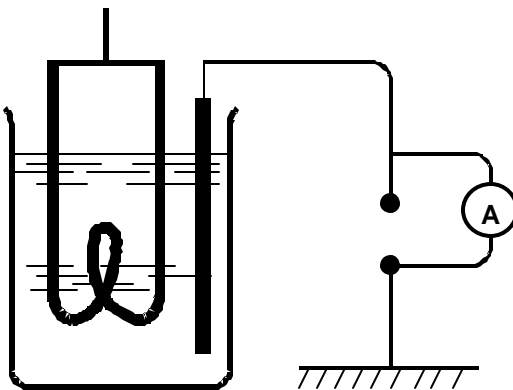

Figure 8: Connecting Cable Insulation Test Setup

TEST 3 POLE INSULATION

Figure 9 shows the test setup for checking pole insulation using earthed poles. Test voltage is 1.2 times maximum nominal phase to ground voltage for 1 minute; leakage current is less than 125 μA . This test should not be performed on Cat. No. 514500-3 and 514500-4 testers.

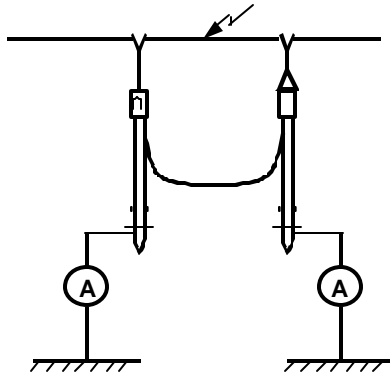

Figure 9: Pole Insulation Test Setup

TEST 4 OPERATING CURRENT

Figure 10 shows the operating current test setup. At maximum nominal voltage, current through the phasing tester is approximately 1 mA.

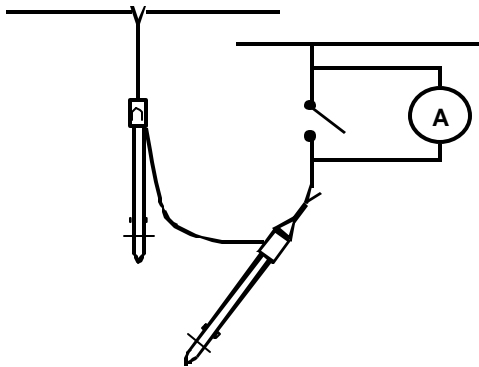

Figure 10: Operating Current Test Setup

TEST 5 MAXIMUM FAULT CURRENT CALCULATIONS

Figure 11 shows the conditions for calculating maximum fault current which could flow accidentally at Test Point A with a faulty cable. The maximum fault current would be:

$$\frac{\text{maximum nominal voltage}}{\sqrt{3} \times \text{auxiliary element resistance}}$$

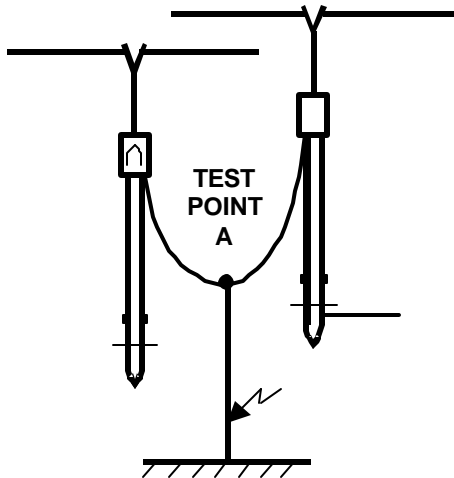

Figure 11: Conditions for Maximum Fault Current

TEST 6 VOLTAGE-ADJUSTING KNOB

To check the correct operation of the voltage-adjusting knob on the LED phasing tester, the following procedure should be performed for at least four different settings over the full range of adjustment.

- Set the voltage-adjusting knob to the desired setting.
- Touch the detector element to a variable source of high voltage (the auxiliary element being held clear).

- c. Raise the voltage to a value equal to the knob setting. Observe the lamp, it should be flashing at its maximum rate.
- d. Touch the auxiliary element simultaneously to the same electrode as the detector element. The lamp should extinguish. A faint flash may still be observed but the difference between this faint flash and maximum intensity flash is considerable and easily discernible.

Refer to Section 7, Troubleshooting, if the tester fails these checks.

Megger 

WARRANTY

Products supplied by Megger are warranted against defects in material and workmanship for a period of one year following shipment. Our liability is specifically limited to replacing or repairing, at our option, defective equipment. Equipment returned to the factory for repair must be shipped prepaid and insured. This warranty does not include batteries, lamps or similar items, where the original manufacturer's warranty shall apply. We make no other warranty. The warranty is void in the event of abuse (failure to follow recommended operating procedures) or failure by the customer to perform specific maintenance as indicated in this manual.

NOTES