

SMRT33

Megger Relay Test System



- **Small, rugged, lightweight and powerful**
- **Operate with or without a computer**
- **Intuitive manual operation with Smart Touch View Interface**
- **High current, high power output (45 Amps/300 VA rms) per phase**
- **Network interface provides IEC 61850 test capabilities**
- **Fully automated testing using AVTS software**
- **Optional transducer test capability**

DESCRIPTION

For size and low weight, the SMRT33 is conceivably the smallest, lightest, highest output powered; complete three phase relay test system in the world today. The SMRT33 provides high power in both the voltage and current channels to test virtually all types of protective relays used in heavy industrial, distributed generation and low- to medium-voltage distribution substations. The SMRT33 has the smart combination of high compliance voltage and high current to test all electromechanical, solid-state and microprocessor-based overcurrent relays, including high impedance directional ground overcurrent. In addition, the unit includes capability to test IEC 61850 devices.

The SMRT33 test system has the ability to be manually controlled with Megger's new Smart Touch View Interface™ (STVI). The STVI, with its large, full color, high resolution, TFT LCD touch screen, allows the user to perform manual, steady-state and dynamic testing quickly and easily using the manual test screen, as well as using built-in preset test routines for the most popular relays (see STVI datasheet for details.)

The STVI eliminates the need for a computer when testing virtually all types of relays. Menu screens and touch screen function buttons are provided to quickly and easily select the desired test function.

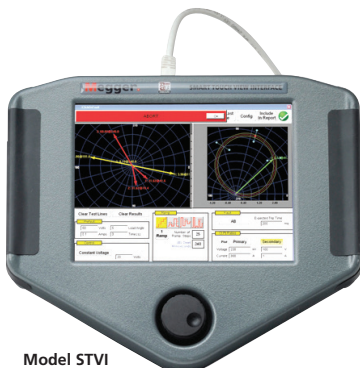

Model STVI

Tests results can be saved to the STVI for download to a memory stick to transfer or print test reports.

For full automatic testing, the SMRT33 may be controlled by Megger Advanced Visual Test Software (AVTS). AVTS is a Microsoft® Windows® XP/Vista™/7/8 compatible software program designed to manage all aspects of protective relay testing using the new Megger SMRT33, (see AVTS datasheet for details.)

APPLICATIONS

Each current channel is rated for 32 Amps @ 200 VA continuous, up to 45 amps @ 300 VA for short durations. It has a unique flat power curve from 4 to 32 amps that insures maximum compliance voltage to load at all times. Three currents in parallel can provide up to 135 amps @ 900 VA for testing instantaneous overcurrent relays. With a maximum compliance voltage of 50 volts rms per phase, with just two channels in series, the SMRT33 provides 100 Volts rms of compliance voltage to test high impedance ground overcurrent relays.

Each voltage channel can provide variable outputs of 0-30/150/ 300 volts at 150 VA of output power, and has a unique flat power curve from 30 to 150 volts insuring maximum output power to the load at all times.

Using the Ethernet ports, the SMRT33 is a plug-and-play unit where voltage and current outputs seamlessly synchronize for testing more complex applications, even back-to-back or up to 30 phase current.

FEATURES AND BENEFITS

Constant Power Output: New higher powered voltage-current amplifiers. The current amplifier delivers maximum compliance voltage to the load constantly during the test, and range changing is done automatically under load. This insures better test results, and saves time by not having to turn the outputs off to change

ranges. Constant power output in many cases eliminates the need to parallel or series current channels together to test high burden relays.

High Output Current: Provides up to 32 amps at 200 VA per phase continuous. The three current amplifiers can be paralleled to provide a maximum of 135 amperes at 900 VA, for testing instantaneous overcurrent relays.

New PowerV™ Voltage Amplifier High Power Output: The SMRT33 provides a new higher VA power output on the voltage channel at the lower critical test voltages (from 30 to 150 volts). Customers who want to test a panel of relays at one time find it impossible using lower VA rated voltage amplifiers.

Steady-State and Dynamic testing capability: The SMRT33 provides, either through manual control or computer control, both steady-state and dynamic testing of protective relays. This includes programmable waveforms with DC offset and harmonics.

Output current and voltage sine waves are generated digitally: Outputs do not vary with sudden changes in input voltage or frequency, which increases test accuracy and reduces testing time.

Digital binary inputs and outputs: The programmable binary inputs, and programmable outputs provide timing and logic operations in real-time with the output voltage and currents. Binary Inputs can be programmed, using Boolean logic, for more complex power system simulations. This provides a low cost, closed loop power system simulator.

Circuit breaker simulator: Binary outputs provide programmable normally closed and normally open contacts to simulate circuit breaker operation for testing reclosing relays. Sequence of operation, timing, and lockout are easily tested.

Performs transient tests: Perform acceptance or troubleshooting tests by replaying digitally recorded faults or EMT/ATP simulations in the IEEE- C37.111, COMTRADE standard format.

Perform End-to-End tests: Using AVTS or RTMS software and a portable GPS satellite receiver, the SMRT performs satellite-synchronized end-to-end dynamic multi-state (AVTS or RTMS) or playback transient COMTRADE files (AVTS) either for commissioning or troubleshooting tests.

Wide-ranging output frequency: The output frequency of the current and voltage channels can be set for any frequency from dc to 1 kHz. Multi-purpose test system saves time and money.

Three Ethernet ports: PC/OUT Ethernet port is the primary PC connection port, or used to interconnect multiple SMRT units together for synchronous multi-unit operation. The IN/61850 Ethernet port is used to interconnect multiple SMRT units together for synchronous multi-unit operation or to connect to the IEC 61850 substation bus. The STVI PoE (power over Ethernet) port and is used to connect to the STVI.

Bluetooth: Optional Bluetooth provides more flexibility. A wireless interface between the PC and SMRT, in conjunction with the SMRT IEC 61850 Ethernet port, provides the isolation required for a secure substation access interface between the SMRT and the IEC 61850 substation network.

Open communication architecture: Use with third party software for more flexible automated control.

Immediate error indication: Audible and visual alarms indicate when amplitude or waveforms of the outputs are in error.

Optional Transducer Testing Capability – This optional hardware feature (see Ordering Information) provides transducer DC Inputs to test transducers easily and effectively. The STVI software is designed

to automatically recognize the Transducer DC Inputs, and thus provide the Transducer Test Screen when selected. AVTS software comes standard with Transducer Test Modules, which will provide automatic transducer test capability in conjunction with the optional hardware.

SMRT33 RELAY TESTER

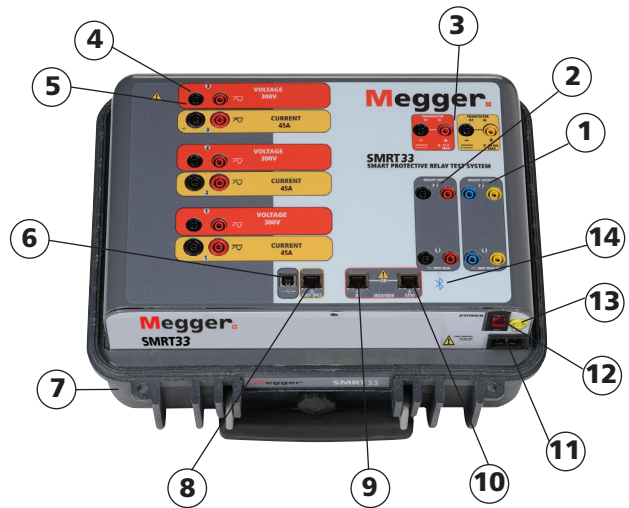

- 1. **Binary Outputs #1 and 2:** Rated for 300 V at 8 amps.
- 2. **Binary Inputs #1 and 2:** Rated 5 to 300 V AC/DC.
- 3. **Transducer Input:** (Optional) DC voltage and DC milliamp input terminals.
- 4. **Voltage Outputs:** 3 channels 0-300 V at 150 VA.
- 5. **Current Outputs:** 3 channels 0-32 amps at 200 VA per phase, up to 135 amps at 900 VA single phase.
- 6. **USB 2.0 Interface:** Communication and control port.
- 7. **Rugged Case:** Fiberglass reinforced plastic.
- 8. **PC/OUT:** Ethernet port is the primary PC connection port.
- 9. **IN/61850:** Ethernet port used to chain multiple SMRT units together for synchronous multi-unit operation. This port may also be used for connecting to the IEC 61850 substation bus for testing IEC 61850 devices.
- 10. **STVI:** Ethernet port is a PoE (Power over Ethernet) port and is used to connect to the STVI for manual control.
- 11. **Incoming Power/Line Cord Socket:** 100 to 240 V, 50/60 Hz.
- 12. **POWER ON/OFF Switch:** Illuminates when power is on.
- 13. **Protective Earth Ground Jack.**
- 14. **Bluetooth:** Bluetooth® provides wireless control.

APPLICATIONS SELECTION GUIDE

	Protective Relays by IEEE Device #	SMRT 33
2	Time Delay	■
21	Distance Single Phase	■
21	Distance Three Phase Open Delta	■
21	Distance Three Phase Wye	■
24	Volts/Hz	■
25	Synchronizing	■
27/59	Under/Over Voltage	■
32	Directional Power Single Phase	■
32	Directional Power Three Phase (Open Delta)	■
37/76	DC Under/Over Voltage/Current	■
40	Loss of Field	■
46	Phase Balance Current	■
46N	Negative Sequence Overcurrent	■
47	Phase Sequence Voltage (Open Delta)	■
50	Instantaneous Overcurrent	Up to 135 Amps
51	Time Delay Overcurrent	Up to 90 Amps
55	Power Factor	■
60	Voltage / Current Balance (Open Delta)	■
67	Directional Overcurrent	■
67N	Ground Directional Overcurrent	■
78	Out of Step	■
79	Reclosing	■
81	Frequency	■
85	Carrier or Pilot Wire	■
87	Differential	■
91	Voltage Directional (Open Delta)	■
92	Voltage and Power Directional (Open Delta)	■
94	Tripping	■

SPECIFICATIONS¹

Input Power 100 to 200 volts (±10%) AC, 1Ø, 50/60 Hz, 1000 VA
 220 to 240 volts (±10%) AC, 1Ø, 50/60 Hz, 1600 VA

Outputs

All outputs are independent from sudden changes in voltage and frequency and are regulated so changes in load impedance do not affect the output. All amplifier outputs are isolated or floating. The SMRT units can be ordered with the amplifier common returns tied to chassis ground as an option.

Output Current Sources

The SMRT33 per channel output current and power ratings are specified in AC rms values and peak power ratings.

Output Current	Power	Max V/Duty Cycle
1 Ampere	15 VA	15.0 Vrms Continuous
4 Amperes	200 VA (282 peak)	50.0 Vrms Continuous
15 Amperes	200 VA (282 peak)	13.4 Vrms Continuous
32 Amperes	200 VA (282 peak)	6.67 Vrms Continuous
45 Amperes	300 VA (424 peak)	6.67 Vrms 1.5 Seconds

DC 200 Watts

With three currents in parallel:

Output Current	Power	Max V/Duty Cycle
12 Amperes	600 VA (848 peak)	50.0 Vrms Continuous
45 Amperes	600 VA (848 peak)	13.4 Vrms Continuous
96 Amperes	600 VA (848 peak)	6.67 Vrms Continuous
135 Amperes	900 VA (1272 peak)	6.67 Vrms 1.5 Seconds

With two currents in series:

The compliance voltage doubles to provide 4.0 amperes at 100 Volts rms.

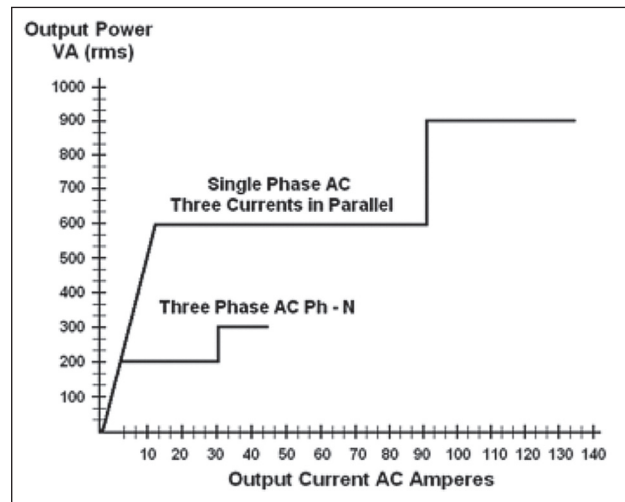

Current Amplifier – Flat Power Curve

The SMRT current amplifier provides a unique flat power curve from 4 to 32 Amperes per phase to permit testing of electromechanical high impedance relays, and other high burden applications.

¹ Megger reserves the right to change product specifications at any time.

AC Voltage Output

Outputs are rated with the following ranges:

Output Volts	Power	Max I
30 Volts	150 VA	5 Amps
150 Volts	150 VA	Variable ³
300 Volts	150 VA	0.5 Amps

DC 150 Watts

Duty Cycle: Continuous

³ PowerV™ voltage amplifier output current varies depending on the voltage setting on the 150 Volt range, see curve.

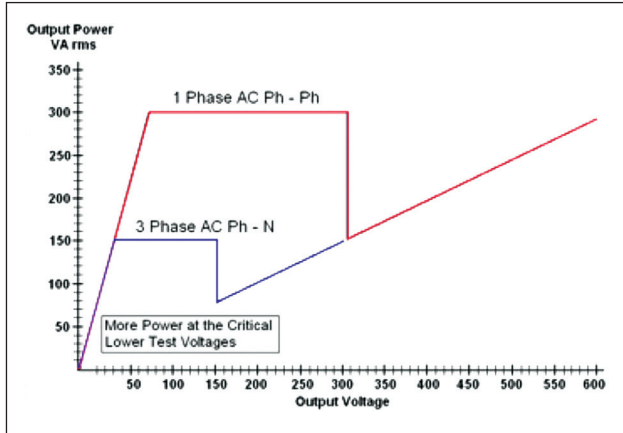

“PowerV™” Voltage Amplifier - Extended Power Range

The SMRT voltage amplifier provides a flat power curve from 30 to 150 volts in the 150V range to permit testing of high current applications such as panel testing.

- Phase Angle** Ranges 0.00 to 359.99 degrees, counter clock wise, or clock wise rotation, or 0.00 to ±180.00 degrees
- Accuracy:** ±0.02° typical, ±0.25° max at 50/60 Hz
- Frequency:** The output modules provide a variable frequency output with the following ranges and accuracy
- Ranges**
 - DC
 - 0.001 to 1000.000 Hz
 - Output amplifiers can provide transient signals with a range of DC to 10 kHz for transient playback using COMTRADE files.
- Resolution:** .001 Hz
- Frequency Accuracy:** 2.5 ppm typical
- Accuracy:** 25 ppm 0° to 50° C, at 50/60 Hz Maximum
- Total Harmonic Distortion** Less than 0.1% typical, 2% maximum at 50/60 Hz
- Timer:** The timer-monitor Input is designed to monitor and time-tag inputs, like a sequence of events recorder. In addition, the binary input controls enable the user to perform logic and/or functions and conditionally control the binary output relay to simulate circuit breaker, trip, reclose and carrier control operation in real-time. The timer function displays in seconds or cycles with the following range and resolution:
- Seconds:** 0.0001 to 99999.9

- Cycles:** 0.01 to 99999.9
- Accuracy:** ±0.001% of reading, typical. ±2 least significant digit ±0.005% of reading from 0 to 50° C maximum
- Binary Input – Start/Stop/Monitor Gate** To monitor operation of relay contacts or trip SCR, continuity, light is provided for the input gate. Upon sensing continuity the lamp will glow. In addition to serving as wet/dry contacts the binary Inputs may be programmed to trigger binary output sequence(s)
- Number:** The first two VIGENS have 1 each.
- Input Rating:** up to 300 V AC/DC
- Binary Output** SMRT33 has independent, galvanically-isolated output relay contacts to accurately simulate relay or power system inputs to completely test relays removed from the power system. The binary output simulates normally open/ normally closed contacts for testing breaker failure schemes. The binary output can be configured to change state based on binary input logic.
- High Current Output Relays:** There are two binary output relays.
- AC Rating:** 400 V max., I_{max}: 8 amps, 2000 VA max
- DC Rating:** 300 V max., I_{max}: 8 amps, 80 W
- Response Time:** <10ms
- Waveform Generation** Each output channel can generate a variety of output waveforms such as: DC; sine wave; sine wave with percent harmonics at various phase angles; half waves; square waves with variable duty cycles; exponential decays; periodic transient waveforms from digital fault recorders, relays with waveform recording capability or EMTP/ATP programs, which conform to the IEEE C37.111 COMTRADE standard format
- Metering** Measured output quantities such as AC amperes, AC Volts, DC volts or DC amperes, and time may be simultaneously displayed on the large, color TFT LCD touch screen. The AC and DC outputs display the approximate voltage/current output prior to initiation of the outputs. All accuracies stated are from 10 to 100% of the range at 50/60Hz
- AC Voltage Amplitude Accuracy:** ±0.05 % reading + 0.02 % range typical, ±0.15 % reading + 0.05 % range maximum
- Resolution:** .01
- Measurements:** AC RMS
- Ranges:** 30, 150, 300 V
- AC Current Amplitude Accuracy:** ±0.05 % reading + 0.02 % range typical, ±0.15 % reading + 0.05 % range maximum
- Resolution:** .001/.01

Measurements: AC RMS
Ranges: 32, 45 A

DC Voltage Amplitude

Accuracy: 0.1% range typical, 0.25% range maximum
Resolution: .01
Measurements: RMS
Ranges: 30, 150, 300 V

DC Current Amplitude

Accuracy: ±0.05 % reading + 0.02 % range typical, ±0.15 % reading + 0.05 % range maximum
Resolution: .001/.01
Measurements: RMS
Ranges: 32 A

DC IN Inputs (Optional Transducer Feature)

DC IN Volts

Range: 0 to ±10 V DC
Accuracy: ±0.001% reading + 0.005% range typical, ±0.003% reading + 0.02% range max
Resolution: .001
Measurements: Average

DC IN Amperes

Range: 0 to ±1 mA DC, 4 to ±20 mA DC
Accuracy: ±0.001% reading + 0.005% range typical, ±0.003% reading + 0.02% range max
Resolution: .001
Measurements: Average

Environmental

Operating Temperature: 32° to 122° F (0 to 50° C)
 SMRT is rated on a continuous duty basis as described by NEMA for test equipment in intermittent service; that is, 30 minutes ON followed by 30 minutes OFF at ambient room temperature 23° C ±5° C (73° F ±10° F). For longer durations or duty cycles at higher operating temperatures see the instruction manual for more information
Storage Temperature: -13° to 158° F (-25° to 70° C)

Relative Humidity: 5 - 90% RH, non-condensing

Unit Enclosure The SMRT unit comes housed in a rugged, virtually indestructible, lightweight and ergonomic enclosure. It features a large oversized rubber cushioned handle, and removable lid for use in tight spaces

Dimensions

With the lid on: 14.2 W x 7.6 H x 12.0 D in. (360 W x 194 H x 305 D mm)

With the lid off: 14.2 W x 7.2 H x 12.0 D in. (360 W x 180 H x 305 D mm)

IEC Enclosure Rating: IP30

Weight With the transit lid on: 25.4 lb. (11.4 kg)

With the transit lid off: 23.3 lb. (10.5 kg)

Conformance Standards

Safety: EN 61010-1
Shock: MIL-PRF-28800F (30 g/11ms half-sine) IEC 60068-2-27 (15 g/11 ms half-sine)
Vibration: MIL-PRF-28800F (10-500 Hz, 2.05 g rms) IEC 60068-2-6 (10-150 Hz, 2 g)
Transit Drop: MIL-PRF-28800F (10 drops, 46 cm), ISTA 1A

Electromagnetic Compatibility

Emissions: EN 61326-2-1, EN 61000-3-2/3, FCC Subpart B of Part 15 Class A
Immunity: EN 61000-4-2/3/4/5/6/8/11

Protection

Voltage outputs are protected from short circuits and thermally protected against prolonged overloads. Current outputs are protected against open circuits and thermally protected against prolonged overloads.

Communication Interfaces Ethernet (3)
 USB
 Bluetooth (optional)

ORDERING INFORMATION

Style Number Identification

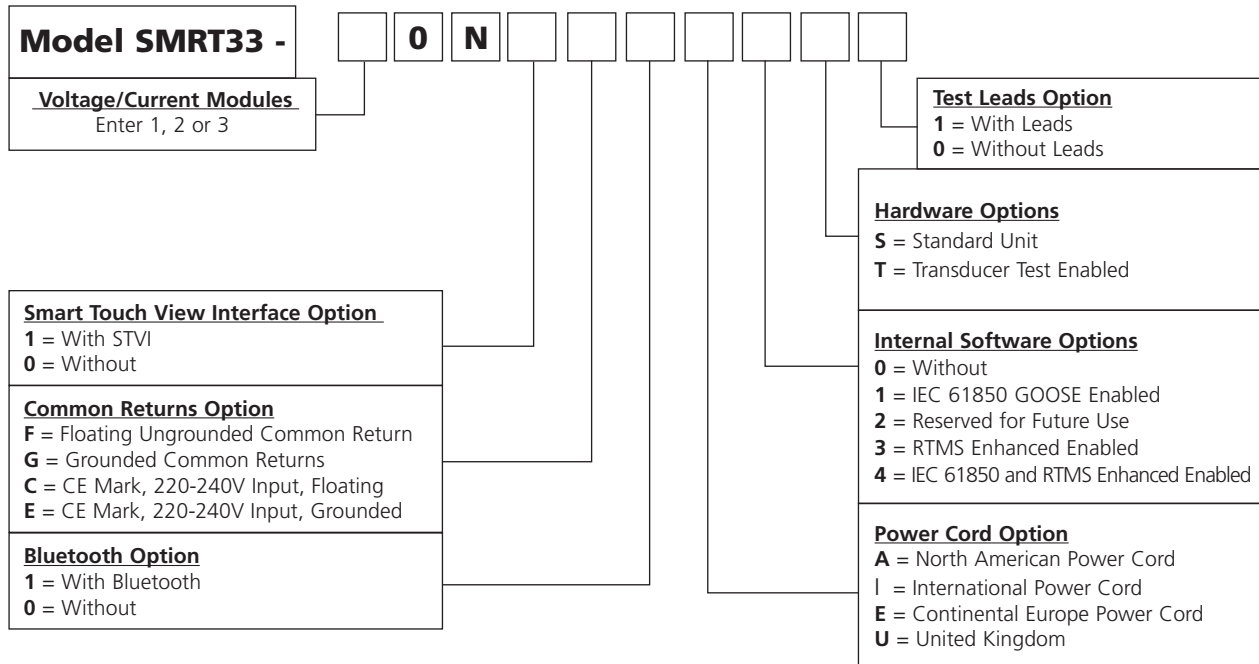

DESCRIPTIONS OF HARDWARE OPTIONS

This modular system lets you select the testing capabilities you need now and expand as testing requirements change. Customize the system by adding the number of Voltage-Current amplifier (VIGEN) modules (1, 2, or 3), selecting floating or grounded common returns, power cord, IEC 61850 test capable, standard hardware or transducer feature added, and with or without test leads. See the following descriptions.

Voltage/Current Module: The SMRT33 unit can have 1, 2 or 3 voltage/current modules. Enter the number of desired modules 1, 2 or 3.

Smart Touch View Interface Option: Enter the number **1** for the unit to come with the STVI, or enter the number **0** for without.

Common Returns Option: The floating returns option provides independent isolated return terminals for each output channel. The grounded common returns option, the return terminals are interconnected internally and connected to chassis ground. The CE Mark, C and E units have been certified to the IEC standards for EMC for both the grounded and floating options. The F and G units are designed to operate in countries which do not require the CE mark.

Power Cord Option Customers can choose which type of power cord they want the unit to come with.

- **A** option – NEMA 5-15 to IEC60320 C13 connectors, UL & CSA approved for countries with NEMA outlets.
- **I** option - International color coded wires (light blue, brown and green with yellow stripe) insulation jacket stripped ready for male connector with IEC 60320 C13 connector. CE marked.

- **E** option - CEE 7/7 “Schuko” plug to IEC 60320 C13 connector is CE marked.
- **U** option – United Kingdom power cord with IEC 60320 C13 connector, and 13 Amp fuse. BS 1363 / CE Marked.

Internal Software Options: The SMRT33 in conjunction with the optional Megger GOOSE Configurator (MGC) software can be used in the testing or commissioning of IEC 61850 compliant devices. In order for the SMRT33 to be able to subscribe as well as publish GOOSE messages, the IEC 61850 feature needs to be enabled¹. Enter the number **1** for the unit to come with the IEC 61850 option enabled. The number **2** is reserved for future use. Enter the number **3** to enable additional RTMS software features such as the Synchronizer and Frequency test. Enter the number **4** to have both IEC 61850 and RTMS software features enabled. Enter **0** for the unit without internal enhanced software options enabled.

Hardware Options: **S**= Standard unit. **T**= With Transducer test capability enabled (requires 3 channel configuration). When equipped with the Transducer test feature the total number of binary inputs and outputs are reduced by 1.

¹Requires the Optional Megger GOOSE Configurator software to program the unit to subscribe and publish GOOSE messages, see Software Options for part numbers and descriptions.

Test Leads Option: Enter the number **1** for the unit to come with Test Leads. Enter **0** for the unit without Test Leads.

DESCRIPTION OF SOFTWARE OPTIONS

#	Included Software	Part Number
1	AVTS Basic with RTMS Application Software	81302
Optional Software		
1	AVTS Basic with IEC 61850 Megger GOOSE Configurator, and RTMS Application Software	1002-103
2	AVTS Advanced with RTMS Application Software	81570
3	AVTS Advanced Test with IEC 61850 Megger GOOSE Configurator, and RTMS Application Software	1001-106
4	AVTS Professional with RTMS Application Software	81571
5	AVTS Professional Test with IEC 61850 Megger GOOSE Configurator, and RTMS Application S/W	1002-102

Descriptions of Software

Included Software – Every unit comes with **AVTS Basic**, and the PC version of the **RTMS software**

**AVTS Basic with RTMS software (PC Version)
Part Number: 81302**

AVTS Basic includes Online Vector, Online Ramp and Online Click-On-Fault controls, with the ability to import, execute automatically determine the reach characteristics of single or multi-zone Distance relays using shot for single point tests, or Ramp, Pulse Ramp, or Binary Search tools along user defined search lines. Basic also includes enhanced Relay Test Wizards for; Overcurrent, Differential, Voltage, Frequency and Distance relays. AVTS Basic does not require a software license key to run.

The powerful RTMS software can be run directly from a PC providing both manual and automatic test capabilities. See the RTMS datasheet for more detailed descriptions of test features and capabilities.

**Additional Optional Software
AVTS Advanced with RTMS software
Part Number: 81570**

AVTS Advanced includes all of the features of AVTS Basic in addition to the powerful Test Editor and test editor tools, which includes the Dynamic Control (with dynamic end-to-end test capability, and Recorder features) for developing sequential tests for virtually any function or measuring element within digital relays. In addition, it also includes Modbus communications for automatic download of settings, SS1 File Converter for ASPEN® and CAPE® dynamic test files, End-to-End DFR Playback test capability and basic programming Tools for creating and editing test modules. Software comes with a USB software license key to run on any PC. Test files created in Advanced Test can be used with any PC running AVTS Basic without a software license key.

**AVTS Professional with RTMS software
Part Number: 81571**

Professional Test includes all of the features of AVTS Advanced Test version plus the following additional specialized test tools. The DFR Waveform Viewer and Playback tools are used for viewing and analyzing IEEE C37.111 COMTRADE Standard files from digital fault recorders and microprocessor based relays. The DFR Waveform Viewer includes tools to recreate the analog and digital channels for playback into protective relays for troubleshooting or evaluation. It includes the capability to extend the prefault data as well as start the timer associated with the event to time relay operation. These playback test files can also be used in end-to-end tests to recreate the transient event and evaluate the protection scheme. Test files created in Professional can be used with Advanced Test and Basic. Also included is the One-Touch Test Editor Control Tool for fully automatic testing of microprocessor based relays using VB script files to automatically download relay settings, and automatically test all the measuring elements within the relay based upon those settings. The Waveform Digitizer feature is also included in the Professional Test version of AVTS. It provides tools to create digital time curves for virtually any electromechanical relay time curve (that do not fit a

time curve algorithm). It can even be used for digitizing scanned waveforms from a light-beam chart recorder. Software comes with a USB software license key to run on any PC. Test files created in Professional Test can be used with any PC running AVTS Basic without a software license key.

**IEC 61850 Megger GOOSE Configurator Software
See Table for Part Numbers)**

The Megger GOOSE Configurator (MGC) provides easy to use tools for testing relays and substations using the IEC 61850 protocol. It is an optional software tool available with Basic, Advanced or Professional versions of AVTS Software; see Descriptions of Software Options above. The Configurator provides relay test engineers and technicians the capability to import parameters from configuration files in the Substation Configuration Language (SCL) format, and/or capture GOOSE messages directly from the substation bus. All imported SCL GOOSE messages will be unconfirmed messages. Only captured messages are confirmed messages due to the Capture feature of the MGC. Use the MGC Merge feature to compare imported SCL and captured GOOSE messages to verify all GOOSE messages needed to perform tests. Use them to configure the SMRT to subscribe to preselected GOOSE messages by assigning the data attributes to the appropriate binary inputs of the SMRT. Use the configurator to assign the appropriate binary outputs of the SMRT to publish GOOSE messages simulating circuit breaker status. After the appropriate assignments of binary inputs and outputs have been made, the test file can be saved for reuse. This provides both manual and automatic testing of the relay using either the RTMS or AVTS software. Use standard test modules in AVTS to perform automatic tests. Use the Dynamic Control in AVTS Advanced or Professional to perform high speed trip and reclose tests, or use to perform interoperability high-speed shared I/O tests between multiple IED's. The MGC provides mappings of Boolean and Bit Strings and/or simulation of STRuct, Integer/Unsigned, Float and UTC datasets.

Substation Configuration Language (SCL) format, and/or capture GOOSE messages directly from the substation bus. All imported SCL GOOSE messages will be unconfirmed messages. Only captured messages are confirmed messages due to the Capture feature of the MGC. Use the MGC Merge feature to compare imported SCL and captured GOOSE messages to verify all GOOSE messages needed to perform tests. Use them to configure the SMRT to subscribe to preselected GOOSE messages by assigning the data attributes to the appropriate binary inputs of the SMRT. Use the configurator to assign the appropriate binary outputs of the SMRT to publish GOOSE messages simulating circuit breaker status. After the appropriate assignments of binary inputs and outputs have been made, the test file can be saved for reuse. This provides both manual and automatic testing of the relay using either the RTMS or AVTS software. Use standard test modules in AVTS to perform automatic tests. Use the Dynamic Control in AVTS Advanced or Professional to perform high speed trip and reclose tests, or use to perform interoperability high-speed shared I/O tests between multiple IED's. The MGC provides mappings of Boolean and Bit Strings and/or simulation of STRuct, Integer/Unsigned, Float and UTC datasets.

Test Leads and Accessories







All units come with a power cord (see power cord option) and Ethernet communication cable, and instruction manual CD. All other accessories varies depending on the options selected, see Table of Accessories.

DESCRIPTION

Included Standard Accessories	Part Number
Power Cord - Depending on style number, the unit will come with one of the following power cords:	
Line cord, North American	620000
Line cord, Continental Europe with CEE 7/7 Schuko Plug	50425
Line cord, International color-coded wire	15065
Line cord, United Kingdom	90002-989
Ethernet cable for interconnection to PC, 210cm (7 ft.) long (Qty. 1 ea)	90003-684
Instruction manual CD	80989

TABLE OF ACCESSORIES

Accessories are supplied with the selection of the test leads option, and/or the binary input/output/battery simulator option and/or the STVI option. With the test leads option, the number and type of leads varies depending on the number of channels ordered. If desired, test leads and accessories can be ordered individually. (See description and part numbers below.)

	Descriptions of Optional Test Leads and Accessories	STVI, or Test Leads Option	One (1) Voltage Current Module	Two (2) Voltage Current Modules	Three (3) Voltage Current Modules
	Accessory Carry Case: Use to carry power cord, Ethernet cable, Optional STVI and test leads.	Qty. 1 ea. Part No. 2001-487			
	Sleeved Pair of Test Leads: Sleeved Test Leads, one red, one black, 200 cm (78.7") long, 600 V, 32 Amperes CAT II	Qty. 3 pr. Part No. 2008-539	Qty. 3 pr. Part No. 2008-539	Qty. 6 pr. Part No. 2008-539	Qty. 2 pr. Part No. 2008-539
	Cable/Spade Lug Adapter (Small): Small lug fit most new relay small terminal blocks. Lug adapter, red, 4.1 mm, use with test leads up to 1000 V/ 20 Amps CAT II.	Qty. 3 ea. Part No. 684004	Qty. 3 ea. Part No. 684004	Qty. 6 ea. Part No. 684004	Qty. 12ea. Part No. 684004
	Lug adapter, black, 4.1 mm, use with test leads up to 1000 V/ 20 Amps CAT II.	Qty. 3 ea. Part Number 684005	Qty. 3 ea. Part Number 684005	Qty. 6 ea. Part Number 684005	Qty. 12ea. Part Number 684005
	Jumper Lead: Jumper lead, black, 12.5 cm (5") long, use with voltage / current outputs, 600 V, 32 Amps CAT II			Qty. 2 ea. Part Number 2001-573	Qty. 4 ea. Part Number 2001-573
	4x6 Sleeved Combination Voltage Leads with Retractable Shrouds: Keeps the test leads from getting entangled. Three common leads connect to the test set, which are interconnected down to one black common to connect to the relay under test. Sleeved Three Phase Test Leads, 200 cm (78.7") long, 600 V, 32 Amperes CAT II.				Qty. 1 ea. Part Number 2008-540
	6x6 Sleeved Combination Voltage Leads with Retractable Shrouds: Keeps the test leads from getting entangled. Three pairs of leads connect to the test set, with three pairs to connect to the relay under test. Sleeved Three Phase Test Leads, 200 cm (78.7") long, 600 V, 32 Amperes CAT II				Qty. 1 ea. Part Number 2008-541

Note that the sleeved combination leads only come with the three module configuration.

Deluxe Test Leads and Accessories Kit Part No.: 1001-619

The test leads and test lead accessories are an option. Test leads and accessories can be ordered with the unit or later as a kit. The Deluxe Test Leads and Accessories Kit includes sleeved pairs of leads for use with the extra binary inputs/outputs/battery simulator option, as well as the three phase sleeved combination leads for voltage and current channels. The following test leads and test lead accessories are included in the Deluxe Test Leads and Accessories Kit in quantities shown.

DESCRIPTION	Part No.
Sleeved Pair of Test Leads: Sleeved Test Leads, one red, one black, 200 cm (78.7") long, 600 V, 32 Amperes CAT II	2008-539
4x6 Sleeved Combination Voltage Leads with Retractable Shrouds: Keeps the test leads from getting entangled. Three common leads connect to the test set, which are interconnected down to one black common to connect to the relay under test. Sleeved Three Phase Test Leads, 200 cm (78.7") long, 600 V, 32 Amperes CAT II.	2008-540
6x6 Sleeved Combination Voltage Leads with Retractable Shrouds: Keeps the test leads from getting entangled. Three pairs of leads connect to the test set, with three pairs to connect to the relay under test. Sleeved Three Phase Test Leads, 200 cm (78.7") long, 600 V, 32 Amperes CAT II	2008-541
Jumper lead: black, 12.5 cm (5") long, use with voltage/current outputs, 600 V, 32 amps CAT II (Qty. 4 ea.)	2001-573
Cable/Spade lug adapter (small): Small lug fits most new relay small terminal blocks.	684004
Lug adapter: red, 4.1 mm, use with test leads up to 1000 V/ 20 amps CAT II (Qty. 15 ea.)	684005
Lug adapter: black, 4.1 mm, use with test leads up to 1000 V/20 amps CAT II (Qty. 15 ea.)	684005
Accessory case: black, used to carry test leads and/or STVI (Qty. 1 ea.)	2003-725



Additional Accessories (Not Included in the SMRT33 Test Leads Option or Deluxe Lead Kit)

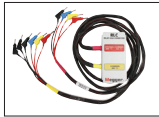

Additional Optional Test Leads and Accessories can be ordered individually, see description and part numbers below. The following accessories and part numbers are in quantities of 1 each. Order the appropriate number required.

RLC, Relay Lead Connector: Excellent for easily connecting three phase voltage and current leads to the test system.	
	
Two sets of test leads (one for voltages and one for currents), sleeved, 4 mm (0.16 in.) terminals with retractable safety shrouds, color coded red, yellow, blue, black, 200 cm long (78.7") 600 V/ 32 Amps CAT II	RLC

DESCRIPTION	Part No.
Individual (non-sleeved) test leads: Excellent for widely separated individual terminal test connections.	
	
Test lead: red, use with voltage/current output, or binary I/O, 200 cm long (78.7") 600 V/32 amps CAT II	620143
Test lead: black, use with voltage/current output, or binary I/O, 200 cm long (78.7") 600 V/32 amps CAT II	620144

Individual (non-sleeved) extra long test leads: Excellent for widely separated individual terminal test connections.	
	
Extra long test lead, black, use with voltage/current output, or binary I/O, 360 cm long (12 ft) 600 V/32 Amps CAT II.	2003-172
Extra long test lead, red, use with voltage/current output, or binary I/O, 360 cm long (12 ft) 600 V/32 Amps CAT II.	2003-173

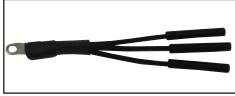
Cable/Spadelug adapter (large): Large spade lug fits older relay terminal blocks, or STATES® Company FTP10 or FTP14 Test paddles, ABB or General Electric test plugs with screw down terminals.	
	
Lug adapter: red, 6.2 mm, use with test leads up to 1000 V/20 Amps CAT II	684002
Lug adapter: black, 6.2 mm, use with test leads up to 1000 V/20 Amps CAT II	684003
Alligator/Crocodile Clip: Excellent for test connections to terminal screws and pins where spade lugs cannot be used	
	
Alligator clip: red, use with test leads up to 1000 V/32 Amps CAT III	684006
Alligator clip: black, use with test leads up to 1000 V/32 Amps CAT III	684007
Flexible test lead adapter: Use with rail-mounted terminals or screw clamp connections where spade lugs and crocodile/alligator clips cannot be used	

DESCRIPTION	Part No.
 <p>Parallel test lead adapter: Used when paralleling up to three current test leads together to a common test point. Usually used when connecting to a test paddle (like the pictured States Company test paddle.)</p>	1002-286
 <p>Flexible test lead adapter: black, 1.8 mm male pin, use with test leads up to 1000 V/32 Amps CAT III</p>	90001-845
<p>Flexible test lead adapter with retractable insulated Sleeve: Use for connection to old style non-safety sockets with retractable protective sleeve on one end</p>	
 <p>Retractable sleeve test lead: red, 50 cm (20") long, use with test leads up to 600 V/32 amperes CAT II</p>	90001-843
<p>Retractable sleeve test lead: black, 50 cm (20") long, use with test leads up to 600 V/32 amperes CAT II</p>	90001-844

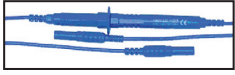
<p>In-line fused test lead: Use with high speed binary outputs 5 or 6 ("P" Option) to protect for accidental switching of currents higher than 1 amp</p>	
	
<p>Test lead: blue, in-line 500 mA fuse protection, 200 cm long (78.7")</p>	568026

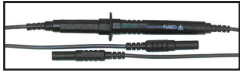
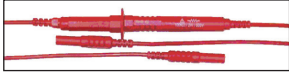
<p>In-line fused test lead: Use with ("P" Option) battery simulator output to protect for accidental connection to substation battery</p>	
	
<p>Test lead: black, in-line 3.15 A fuse protection, 200 cm long (78.7")</p>	568025
<p>In-line resistor test lead: Use with old solid state relays with "leaky" SCR trip gates</p>	
	
<p>Test lead: red, in-line 100 k Ohm resistor, use with test leads up to 1000 V/32 amps CAT III</p>	500395

DESCRIPTION	Part No.
<p>STATES® 10 Pole test paddle: Use with STATES FMS test switch or ABB FT-1 10 pole test switch</p>	
	
<p>Test paddle features knobs which also serve as insulated Ø 4 mm rigid socket accepting spring loaded Ø 4 mm plugs with rigged insulating sleeve, or retractable sleeve. Use with test leads up to 600 V, 32 amperes CAT II</p>	V1TP10

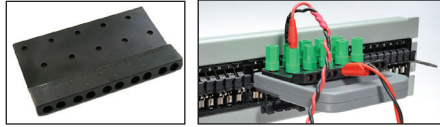
<p>STATES® 10 Pole test paddle attachment: Use with STATES V1TP10 test paddle.</p>	
	
<p>Test paddle attachment provides an additional 10 insulated connection points for front connection, as well as the standard top connections for test leads. Adapter can provide convenient parallel test connections of test currents to two terminals at one time. Use with test leads up to 600 V, 32 amperes CAT II</p>	TPA10

Transit Case	
<p>Hard-sided transit case: Includes custom designed foam inserts for the SMRT unit and accessory case. Transit case includes retractable handle, polyurethane wheels with stainless steel bearings, double-throw latches, fold-down handles, and stainless steel hardware and padlock protection, with O-ring seal making the case water-tight, with an IP 67 rating. Tested and certified to US Department of Defense standards for impact, vibration, and low/high storage temperatures. The case is small, and weighs only 25 pounds (11.25 kg). With a three channel SMRT33, it is light enough to check as luggage on commercial airliners.</p>	
	
<p>Rugged, hard-sided transit case (1ea).</p>	1001-632

