



Motion accessories like transducers, mounting kits and unique adapters. Products for DRM and First trip measurements, and much more.

Circuit breaker testing accessories

Contents

Cables	3
DCM – DualGround	10
Software	12
Application kits	13
Static and dynamic resistance measurement	15
Transducers	18
Linear	18
Rotary	19
Transducer mounting kits	20
Universal kits	20
Circuit breaker specific kits	22
Ready-to-use kits – Rotary	25
Transducer mounting accessories	26
Other	28
Ferrites Dimensions	32
Transducer mounting examples	34

Welcome to Megger Sweden’s accessory catalog for circuit breaker products. Inside, you’ll find a wide range of accessories designed for use with products like EGIL200, EGIL, TM1700, and TM1800. Explore our latest additions, including EGIL200 accessories and new motion transducer kits.

If you have any inquiries about these accessories and their applications, don’t hesitate to reach out to us at support.sweden@megger.com. Our support team is available to assist you via email, phone, and webinars. You can also access application guides and instructional videos on megger.com and on our YouTube channel. For instance:

EGIL200 How-to video:



DRM video:



Egil How-to video:



Product image disclaimer.

Please note that we make every effort to ensure that our product images are as accurate as possible. However, there may be slight discrepancies between the product image and the actual product.

Product Updates

Occasionally, We may make minor updates or changes to product design after photography has taken place.







Cables

Item	Description	TM17/1800	EGIL200	TM1600	EGIL	Part No.
Cables						
Analog Input XLR/Banana	 <p data-bbox="663 689 1086 741">XLR3 female / 4 mm safety plugs, 1 m (3.3 ft). For customized analog transducer connection</p>	X	X	X	X	GA-00040
Cable Analog XLR/open ends	 <p data-bbox="663 992 1007 1021">XLR3 female / open ends, 1 m (3.3 ft)</p>	X	X	X	X	GA-00041
Extension cable Analog Input	 <p data-bbox="663 1245 1059 1296">For analog input, XLR3 female / XLR3 male Analog cable EGIL/TM, 7.5 m (24.6 ft)</p>	X	X	X	X	GA-00042
Transducer cable, XLR / IP / TS	 <p data-bbox="663 1525 1147 1576">NOVOTECHNIK IP / TS, XLR3 female / M16-5 female, 1 m (3.3 ft)</p>	X	X	X	X	GA-00044
Transducer cable, XLR / TLH / LWH	 <p data-bbox="663 1776 1166 1827">NOVOTECHNIK TLH / LWH, XLR3 female / Hirschmann GDM 3009 female, 0.5 m (1.6 ft)</p>	X	X	X	X	GA-00049
Transducer cable XLR / LWG	 <p data-bbox="663 2033 1134 2085">NOVOTECHNIK LWG, XLR3 female / M12-4 female, 0.5 m (1.6 ft)</p>	X	X	X	X	GA-00050





Cables

Item	Description	TM17/1800	EGIL200	TM1600	EGIL	Part No.
<p>Cable Current clamp</p> 	<p>For current clamp, BNC female / XLR3 female, 0.3 m (1 ft)</p>	X	X	X	X	GA-00140
<p>Cable, extension EGIL Timing MAIN</p> 	<p>Extension cable for time measurement of main contacts, XLR5 female / XLR5 male 10 m (32.8 ft)</p>				X	GA-00150
<p>Cable, EGIL Timing</p> 	<p>Timing main, XLR5 female / 4 mm banana incl. clamps, 5 m (16.4 ft)</p>				X	GA-00160
<p>Cable, EGIL Timing AUX</p> 	<p>Timing AUX1&2, XLR5 female / 4 mm banana excl. clamps, 2 m (6.5 ft)</p>				X	GA-00170
<p>Cable, EGIL Voltage sense</p> 	<p>SDRM voltage sense cable, XLR5 female / 4 mm banana, incl. clamps, 2 m (6.5 ft)</p>				X	GA-00175
<p>Cable set, Timing TM1800 AUX TM1700 AUX TM1600 MAIN TM1600 AUX EGIL200 AUX</p> 	<p>The cable sets consist of 8 cables with clamps and 4 mm stackable safety plugs. For timing of CB contacts.</p>	X	X	X		GA-00231
	5 m (16.4 ft)					
	10 m (32.8 ft)					
	15 m (49.2 ft)					
	20 m (65.6 ft)					
	25 m (82 ft)					
	40 m (131 ft)					

Cables

Item	Description	TM17/1800	EGIL200	TM1600	EGIL	Part No.
<p>SCA600/Coax. Cable</p> 	<p>For vibration sensor, BNC male / BNC female, 10 m (32.8 ft)</p>	X		X		GA-00750
<p>Extension cable Analog input</p> 	<p>XLR3 female / XLR3 male, 1 m (3.3 ft)</p>	X	X	X	X	GA-00760
<p>Cable reel</p> 	<p>20 m (65.5 ft), 4 mm stackable safety plugs</p>					
<p>Black</p>		X	X	X	X	GA-00840
<p>Red</p>		X	X	X	X	GA-00842
<p>Yellow</p>		X	X	X	X	GA-00844
<p>Green</p>		X	X	X	X	GA-00845
<p>Blue</p>		X	X	X	X	GA-00846
<p>Cable Timing MAIN</p> 	<p>Timing M/R XLR3 male / 4 mm banana, 5 m (16.4 ft), Length of the split portion (retractable sock), 2.4 m (8 ft) to 3.8 m (12 ft)</p>	X	X			GA-00850
<p>Extension cable Timing MAIN</p> 	<p>For Timing M/R modules, XLR3 male / XLR3 female, 10 m (32.8 ft)</p>	X	X			GA-00851
<p>Timing MIR medium voltage cable</p> 	<p>3 x XLR3 male to banana, 3 m (9.8 ft) Length of the split portion, 0.5 m (1.6 ft)</p>	X	X			GA-00853





Cables



Item	Description	TM17/1800	EGIL200	TM1600	EGIL	Part No.
<p>Timing MIR high voltage cable</p> 	<p>For 1 break/phase XLR3 male to banana, 5 m (16.4 ft) Length of the split portion (retractable sock), 2.4 m (8 ft) to 3.8 m (12.5 ft)</p>	X	X			GA-00854
<p>Adapter for Doble digital transducer</p> 	<p>For Doble digital transducer, DSUB15 male / DSUB15 female, 0.3 m (1 ft). To connect with EGIL200, adapter GA-00886 is needed.</p>	X	X			GA-00867
<p>Adapter for Siemens digital transducer</p> 	<p>For Siemens digital transducer, DSUB15 male / DIN8 female, 0.3 m (1 ft). To connect with EGIL200, adapter GA-00886 is needed.</p>	X	X			GA-00868
<p>Adapter for Vanguard digital transducer</p> 	<p>For Vanguard digital transducer, Amphenol / DSUB15 male, 0.3 m (1 ft) To connect with EGIL200, adapter GA-00886 is needed.</p>	X	X			GA-00869
<p>Timing AUX cable</p> 	<p>Two black and two red banana test leads in a common sleeve. Including: 4 Adapter for terminal block 4 Cable lug adapter 1 Cable, 5 m, (16.4 ft)</p>	X				GA-00870
<p>Timing AUX cable</p> 	<p>6 banana test leads in a common sleeve, 5 m (16.4 ft) Length of the split portion, 0.5 m (1.6 ft) Includes connection adapters</p>		X			GA-00871
<p>Current clamp adapter for EGIL200 Timing MIR, DRMIVDS input</p> 	<p>XLR3 male / BNC female, 0.3 m (1 ft)</p>		X			GA-00873
<p>SDRM voltage sense adapter for EGIL200 Analog input</p> 	<p>XLR3 female / XLR3 female, 0.3 m (1 ft)</p>	X				GA-00874

Cables





Item	Description	TM17/1800	EGIL200	TM1600	EGIL	Part No.
<p><i>Digital transducer cable</i></p> 	<p>For customized digital transducer connection RS422, DSUB15 male / open ends, 10 m (33 ft)</p>	X				GA-00885
<p><i>Digital adapter cable</i></p> 	<p>Digital cable adapter EGIL200 - TM1700 / TM1800 transducer cables, neutriCON male / DSUB15 female, 0.3 m (1 ft).</p>		X			GA-00886
<p><i>Digital transducer extension cable</i></p> 	<p>Digital extension cable, old type, RS422, DSUB15 male / DSUB15 female, 10 m (33 ft)</p>	X				GA-00888
<p><i>Digital transducer cable</i></p> 	<p>For Baumer EIL rotary transducer and SIKO touchless linear transducer, old type, DSUB15 male / M12-8 female, 10 m (33 ft)</p>	X				GA-00889
<p><i>Digital transducer cable</i></p> 	<p>For Baumer EIL rotary transducer and SIKO touchless linear transducer, new type, DSUB15 male / neutriCON female, 10 m (33 ft).</p>	X				GA-00899
<p><i>Adapter for Elcon digital transducer</i></p> 	<p>For using Leine & Linde 530 digital transducer, DSUB15 male / Amphenol, 10 m (33 ft)</p>	X				GA-00890

Cables

Item	Description	TM17/1800	EGIL200	TM1600	EGIL	Part No.
<p><i>Digital transducer and extension cable</i></p> 	<p>Digital transducer cable, neutriCON female / neutriCON male, 10 m (33 ft). Also works as extension cable for GA-00899</p>	X	X			GA-00891
<p><i>Digital transducer cable</i></p> 	<p>For using Baumer BDH16.05A3600-LO-B, digital transducer, DSUB15 male / M23-12 female, 10 m (33 ft)</p>	X				GA-00895
<p><i>Ethernet cable, network</i></p> 	<p>Cable for connection to network/LAN, RJ45, 5 m (16 ft)</p>	X	X			GA-00970
<p><i>TM1700/1800/EGIL200 DCM extension cable</i></p> 	<p>1 DCM extension cable, DIN 6 male / DIN 6 female, 10 m (33 ft) Old type</p>	X				GA-00998
<p><i>Extension cable Analog Input</i></p> 	<p>1 DCM extension cable, DIN 7 male / DIN 7 female, 10 m (33 ft) Actual type. (See also kit of three DCM extension cables CG-19181)</p>	X	X			GA-00999
	<p>For analog input, XLR3 female / XLR3 male Analog cable EGIL/TM, 10 m (33 ft)</p>	X	X	X	X	GA-01005

Item	Description	TM17/1800	EGIL200	TM1600	EGIL	Part No.
<p>Cable kit Control</p> 	<p>Control cable kit, 5 banana test leads in a common sleeve Including: 5 Test clip 5 Adapter for terminal block 5 Cable lug adapter 5 5 m (16 ft) 2 0.25 m (10") 2 Jumper 1 Plastic box</p>	X	X			GA-90002
<p>HV Timing cable kit</p> 	<p>Timing M/R extension, XLR3 male / XLR3 female 5 Cables, 10 m (32.8 ft)</p>	X	X			GA-90005
<p>Connection kit for Control cables</p> 	<p>Including: 5 Test clip 5 Adapter for terminal block 5 Cable lug adapter 1 Plastic box</p>	X	X	X	X	GA-90010



DCM – DualGround

Item	Description	TM17/1800	EGIL200	TM1600	EGIL	Part No.
DCM – DualGround						
DCM1700	DCM TM1700 DualGround™ timing					
	3- channels Including: 3 test cables, 11 m (35 ft) 6 clamps KD-03040	X ¹⁾				BL-59190
	6-channels Including: 6 test cables, 11 m (35 ft) 12 clamps KD-03040	X ¹⁾				BL-59192
DCM200	DCM200 DualGround™ timing Requires Software license CM-8002X					
	3- channels Including: 3 test cables, 11 m (35 ft) 6 clamps KD-03040		X			CM-09290
	6-channels Including: 6 test cables, 11 m (35 ft) 12 clamps KD-03040		X			CM-09292
TM1700/1800/EGIL200 DCM Upgrade cable kit	Cables for 3 channels addition DualGround™ upgrade from 3 to 6 channels Length of the 1-cable portion, 10 m (33 ft) Length of the 2-cable portion, 1.5 m (5 ft) Including: 3 DCM cable units 6 clamps					
			X	X		CG-19180
TM1700/1800/EGIL200 DCM Extension cable kit	DualGround cable, DIN 7, extension for 3 channels 10 m (33 ft), 3 x GA-00999					
		X	X			CG-19181
DCM - TM1800	Module for TM1800					
	DCM Module 3 DCM cables, 11 m (35 ft) DCM to Timing M/R cable 6 clamps Accessory bag					
					X ²⁾	CG-19190
	DCM Module 6 DCM cables, 11 m (35 ft) DCM to Timing M/R cable 12 clamps Accessory bag					
					X ²⁾	CG-19192

¹⁾ Only for TM1700

²⁾ Only for TM1800

DCM – DualGround





Item	Description	TM17/1800	EGIL200	TM1600	EGIL	Part No.
<p>DCM Span extension cable</p> 	<p>To extend the span of the test leads when the distance between connection points is longer than 3 m (9.8 ft). BNC male / BNC female, 2 m (6.6 ft)</p>	X	X			GA-00720
<p>DCM Cable link</p> 	<p>DCM to Timing M/R, DSUB9 male / 3 x XLR3 male, 0.3 m (1 ft)</p>	X ³⁾				GA-12900

³⁾ Only for TM1800

Software

Item	Description	TM17/1800	EGIL200	TM1600	EGIL	Part No.
Software						
<i>CABA Win</i>						
	For TM1700/1800, incl. Ethernet cable GA-00970	X				CG-8000X
	For TM1600, incl. fiberoptics and USB interface			X		BL-8203X
	For EGIL, incl. USB cable				X	BL-8206X
	Upgrade from R04 and lower to latest version, including Test Plan Editor (TPE)	X		X	X	CG-8040X



Application kits

Item	Description	TM17/1800	EGIL200	TM1600	EGIL	Part No.
Application kits						
<i>First trip kit</i>						
	<p>For single operating mechanism, 1 + 3 clamps</p> <p>For three operating mechanisms, 3 + 3 clamps</p>	X	X			BL-90700
<i>Synchro Switch Relay kit</i>						
	<p>Synchronized Switching Relay test kit incl. accessories, software and cables (delivered in transport case)</p> <p>SSR kit for TM 1700/1800</p> <p>SSR for TM1600 (incl. VD401)</p>	X				CG-91200
<i>Trig source selector</i>						
	<p>Combines signals from six trig sources into one single trig signal. Ideal when making online testing and using multiple trig sources, e.g. close command, trip command, spring charge motor, disconnecter and ground switches. Eliminates the need of reconnections between tests since all connections can be made initially.</p>	X	X	X		XB-39265
<i>Transducer calibration kit</i>						
	<p>Plate XB-39022 not included</p>	X	X	X	X	XB-39095

Application kits

Item	Description	Part No.										
<p><i>Vibration kit</i></p> 	<p>The Vibration kit extends TM1800/TM1700/TM1600 and CABA Win with the equipment and software required for recording and analyzing vibration signals at a circuit breaker. The kit includes the signal conditioning unit SCA606, the software CABA Win Vibration and one vibration channel. The vibration solution can be extended up to 6 channels.</p>	<table border="1"> <tr> <td>TM17/1800</td> <td>EGIL200</td> <td>TM1600</td> <td>EGIL</td> <td></td> </tr> <tr> <td>X</td> <td></td> <td>X</td> <td></td> <td>BL-13090</td> </tr> </table>	TM17/1800	EGIL200	TM1600	EGIL		X		X		BL-13090
TM17/1800	EGIL200	TM1600	EGIL									
X		X		BL-13090								
<p><i>Vibration channel</i></p> 	<p>Additional vibration channel to be used together with the Vibration kit. Each Vibration channel includes accelerometer, accelerometer adapter, cables to SCA606 and cables to TM1800/TM1700/TM1600.</p>	<table border="1"> <tr> <td>TM17/1800</td> <td>EGIL200</td> <td>TM1600</td> <td>EGIL</td> <td></td> </tr> <tr> <td>X</td> <td></td> <td>X</td> <td></td> <td>XB-32010</td> </tr> </table>	TM17/1800	EGIL200	TM1600	EGIL		X		X		XB-32010
TM17/1800	EGIL200	TM1600	EGIL									
X		X		XB-32010								





Static and dynamic resistance measurement

Item	Description	TM17/1800	EGIL200	TM1600	EGIL	Part No.		
Static and dynamic resistance measurement								
SDRM201 EGIL	 <p>GB-03431</p>	<p><i>Included accessories:</i></p> <ul style="list-style-type: none"> SDRM Cable for EGIL GB-03431 SDRM multi cable extension, 10 m (33 ft) GA-12812 Voltage sense KG-00175 Voltage sense extension cable GA-00150 Current cable (red) GA-12824 Current cable (black) GA-12834 Clamps (2 pcs) KD-03040 Ground cable, 2.5 mm², 10 m (33 ft) GA-00208 Charger HC-04210 Accessory bag GD-31040 Case GD-00222 				X	CG-90250	
SDRM201 TM1700/TM1800/ EGIL200	 <p>GB-03412</p>	<p><i>Included accessories:</i></p> <ul style="list-style-type: none"> SDRM Cable for TM1700/1800/EGIL200 GB-03412 SDRM multi cable extension, 10 m (33 ft) GA-12812 Current cable (red) GA-12824 Current cable (black) GA-12834 Ground cable, 2.5 mm², 10 m (33 ft) GA-00208 Charger HC-04210 Accessory bag GD-31040 Case GD-00222 				X	X	CG-90260
	 <p>CG-90235</p>	<p>Pack of 3 units (CG-90260) for circuit breaker with 1 Break/Phase Includes 3-phase SDRM cable, CG-90235</p>				X	X	CG-90263

Static and dynamic resistance measurement

Item	Description	TM17/1800	EGIL200	TM1600	EGIL	Part No.
<p>SDRM202 EGIL</p> 	<p><i>Included accessories</i></p> <ul style="list-style-type: none"> SDRM Cable for EGIL GB-03431 SDRM multi cable extension, 10 m (33 ft) GA-12812 Voltage sense KG-00175 Voltage sense extension cable GA-00150 Current cable (red) GA-12824 Current cable (black) GA-12834 Clamps (2 pcs) KD-03040 Ground cable, 2.5 mm², 10 m (33 ft) GA-00208 Charger HC-04210 Accessory bag GD-31040 Case GD-00222 					
<p>SDRM202 TM1700/TM1800/ EGIL200</p>  <p style="text-align: right;">GB-03412</p>	<p><i>Included accessories</i></p> <ul style="list-style-type: none"> SDRM Cable for TM1700/1800 GB-03412 SDRM multi cable extension, 10 m (33 ft) GA-12812 Current cable, red, 2 pcs, 3 m (9.8 ft) GA-12824 Current cable, black 2 pcs, 0.5 m (1.6 ft) GA-12834 Ground cable, 2.5 mm² 10 m (33 ft) GA-00208 Charger HC-04210 Accessory bag GD-31040 Case GD-00222 	X	X			CG-90200
 <p style="text-align: right;">CG-90235</p>	<p>Pack of 3 units (CG-90200) for circuit breaker with 2 Breaks/Phase Includes 3-phase SDRM cable, CG-90235.</p>	X	X			CG-90230



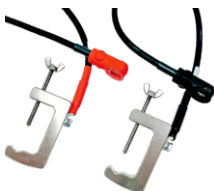

Static and dynamic resistance measurement

Item	Description	TM17/1800	EGIL200	TM1600	EGIL	Part No.
SDRM201/202 Cable						
 <p>GB-03412</p>	<p>Including: SDRM Cable for TM1700/1800/EGIL200 GB-03412 Accessory bag GD-31040</p>	X	X			CG-90205
 <p>GB-03431</p>	<p>Including: SDRM Cable for EGIL GB-03431 Voltage sense extension cable 10 m (33 ft) GA-00150 Accessory bag GD-31040 Voltage sense cable, 2 m (6.5 ft) KG-00175 Clamps 2 pcs KD-03040</p>				X	CG-90225
SDRM201/202						
3-phase SDRM Cable	 <p>For 3-phase measurement at 1 or 2 breaks/phase with TM1700/TM1800/EGIL200 Simplifies connections when using three SDRM201 or SDRM202 units together Including: 3-phase SDRM Cable GB-03460 Power supply HC-04212 Accessory bag GD-31040</p>	X	X			CG-90235
Extension cable, SDRM201/202	 <p>Extension cable for: CG-90200, CG-90220, CG-90250 and CG-90260 10 m (33 ft)</p>	X	X			GA-12812
SDRM201/202						
Current cables and clamps	 <p>For wing nut binding posts. Cable, red 3 m (9.8 ft)</p>	X	X	X	X	GA-12820
	<p>Cable, black, 0.5 m (1.6 ft)</p>	X	X	X	X	GA-12830
	 <p>For quick connectors Cable, red 3 m (9.8 ft)</p>	X	X		X	GA-12824
	<p>Cable, black, 0.5 m (1.6 ft)</p>	X	X		X	GA-12834

Transducers

Item	Description	TM17/1800	EGIL200	TM1600	EGIL	Part No.
Rotary						
Analog						
<i>Transducer kit</i>						
	Novotechnik IP6501 Including: Cable, 1 m (39"), Flex coupling, 6 mm Hexagon wrench	X	X	X	X	XB-31010
Digital						
<i>Transducer kit</i>						
	Baumer EIL580-SC10.5RH.03600.A Including: Flex coupling, 10/6 mm Hexagon wrench Cable GA-00899, DSUB15 male / neutriCON female, 10 m (33 ft)	X				XB-39130
<i>Transducer kit</i>						
	Baumer EIL580-SC10.5RH.03600.A Including: Flex coupling, 10/6 mm Hexagon wrench Cable GA-00891, neutriCON male / neutriCON female, 10 m (33 ft)		X			XB-39131





Transducer mounting kits

Item	Description	TM17/1800	EGIL200	TM1600	EGIL	Part No.
Transducer mounting kits						
Universal kits						
Transducer kit 500/600 mm	 <p>Typically suited for bulk oil circuit breakers. Including: Transducer TLH-500 Transducer adapter cable 0.5 m (GA-00049) L-shaped mounting bracket Pull rod 850 mm with UNF 10/32 threads Transducer/rod clamp Welding clamp Transport case Single phase, Analog, Linear, 500 mm (19.7")</p>	X	X	X	X	XB-40101
	<p>Same as XB-40101 but with transducer TLH-600. Single phase, Analog, Linear, 600 mm (23.6")</p>	X	X	X	X	XB-40102
Transducer kit 300 mm	 <p>Typically suited for SF6 dead tank and bulk oil circuit breakers. Including: Transducer TLH-300 Transducer adapter cable 0.5 m (GA-00049) L-shaped mounting bracket Pull rods 250 mm and 500 mm with UNF 10/32 and UNC 1/4 20 threads Transducer/rod clamp Welding clamp Transport case Single phase, Analog, Linear, 300 mm (11.8")</p>	X	X	X	X	XB-40103
Transducer kit 300 mm	 <p>Same as XB-40103, but with three of each item. 3 phase, Analog, Linear, 300 mm (11.8")</p>	X	X	X		XB-40104



Transducer mounting kits

Item	Description	TM17/1800	EGIL200	TM1600	EGIL	Part No.	
Transducer mounting kits <i>Note: Transducers not included</i>		Same as XB-40101 and XB-40102 but without transducers.	X	X	X	X	XB-40110
		Same as XB-40103 but without transducers.	X	X	X	X	XB-40111
		Same as XB-40104 but without transducers.	X	X	X		XB-40112
Rotary transducer mounting kit	 <p>For transducers XB-31010, XB-39130 and XB-39131</p> <p>Including:</p> <ul style="list-style-type: none"> Clamping base XB-39014 Flexible arm XB-39021 Holder for analog rotary transducer Ø 55 mm XB-39022 Plastic transport case XB-39023 Adapter M6/6 2 Nuts M6 XB-39025 Adapter M8/6 2 Nuts M8 XB-39026 Adapter M10/6 2 Nuts M10 XB-39027 Adapter M12/6 2 Nuts M12 XB-39028 Holder for dig. rotary EIL and linear LWG, Ø 36 mm XB-39005 	X	X	X	X	XB-51010	
Universal transducer mounting kit	 <p>For linear and rotary transducers</p> <p>Including:</p> <ul style="list-style-type: none"> Magnetic base XB-39013 Clamping base XB-39014 Flexible arm XB-39021 Holder for analog rotary transducer Ø 55 mm XB-39022 Plastic transport case XB-39023 Adapter M6/6 2 Nuts M6 XB-39025 Adapter M8/6 2 Nuts M8 XB-39026 Adapter M10/6 2 Nuts M10 XB-39027 Adapter M12/6 2 Nuts M12 XB-39028 Universal support XB-39029 Holder for dig. rotary EIL and linear LWG, Ø 36 mm XB-39005 	X	X	X	X	XB-51020	
Universal adapter for rotary transducer	 <p>Universal adapter to breaker and drive types HPL, LTB, BLG, 8DN9, 8DN8, 3AP1FG, 3AQ, 3DP3, 3AP1FI</p>	X	X	X	X	XB-51060	



Circuit breaker specific kits

Item	Description	TM17/1800	EGIL200	TM1600	EGIL	Part No.
Circuit breaker specific kits						
<i>LTB Kit ABB / Hitachi</i>	 <p>Including: Mounting kit, XB-51010 Universal adapter for rotary transducer XB-51060</p>	X	X	X	X	XB-61010
<i>VD4 Adapter ABB</i>	 <p>Fits with TS-transducer, Stainless steel</p>	X	X	X	X	GB-39030
<i>HPL/BLG Kit ABB / Hitachi</i>	 <p>Including: Mounting kit XB-51010 Universal adapter for rotary transducer XB-51060</p>	X	X	X	X	XB-61020
<i>ELF-HKA/AHMA Kit ABB / Hitachi</i>	 <p>3-phase diagnostic set for ABB / Hitachi drive mechanism type AHMA 4/8 Including: 3 Transducers 3 Adapter cable Mounting details Transport case Calibration certificates</p>	X	X	X		GA-00044 XB-61030



Circuit breaker specific kits

Item	Description	TM17/1800	EGIL200	TM1600	EGIL	Part No.
<p>ELF-HKA/AHMA ABB / Hitachi</p> 	<p>1-phase diagnostic set for ABB drive mechanism type AHMA 4/8 Including: Transducer Adapter cable Mounting details Transport case Calibration certificates</p> <p style="text-align: right;">GA-00044</p>	X	X	X	X	XB-61050
<p>HMB Kit ABB / Hitachi</p> 	<p>3-phase diagnostic set for ABB / Hitachi drive mechanism type HMB 4/8 Including: 3 Transducers 3 Adapter cable 1 Transport case 3 Calibration Certificates</p> <p style="text-align: right;">GA-00044</p>	X	X	X		XB-61040
<p>HMB Kit ABB / Hitachi</p> 	<p>1-phase diagnostic set for ABB / Hitachi drive mechanism type HMB 4/8 Including: Transducer Adapter cable, GA-00044 Transport case Calibration Certificate</p>	X	X	X	X	XB-61060
<p>HMC kit ABB / Hitachi</p> 	<p>1-phase diagnostic set for ABB / Hitachi drive mechanism type HMC Including: Transducer Adapter cable, GA-00044 Transport case Calibration certificate</p>	X	X	X	X	XB-61065

Circuit breaker specific kits

Item	Description	TM17/1800	EGIL200	TM1600	EGIL	Part No.
GL314-GL318 (GE) ABB / Hitachi: ELK-04	 <p>1-phase diagnostic set for below listed breakers: General Electric: GL314(X), GL315(X)[D], GL316(X)[D], GL317(X)[D], GL318(X)[D] , all with FK3-XX mechanism ABB / Hitachi: ELK-04</p> <p>Including: Digital transducer that can be arranged as a slim rotary transducer, depth: 25 mm (1") Digital transducer cable, GA-00891, 10 m (33 ft) Flexible arm, XB-39021 Clamping base, XB-39014 Transport case Assembling tools</p>	X	X	X	X	XB-39276
	3-phase diagnostic set Same as XB-39276 but with three of each item	X	X	X	X	XB-39274
 <p>1-phase diagnostic set for below listed breakers: General Electric: GL314(X), GL315(X)[D], GL316(X)[D], GL317(X)[D],GL318(X)[D], all with FK3-XX mechanism ABB / Hitachi: ELK-04</p> <p>Including: Digital transducer that can be arranged as a slim rotary transducer, depth: 25 mm (1") Digital transducer cable, GA-00899, 10 m (33 ft) Flexible arm, XB-39021 Clamping base, XB-39014 Transport case Assembling tools</p>	X	X	X	X	XB-39272	
	3-phase diagnostic set Same as XB-39272 but with three of each item.	X	X	X	X	XB-39270

Circuit breaker specific kits



Item	Description	TM17/1800	EGIL200	TM1600	EGIL	Part No.
Ready-to-use kits – Rotary						
Analog						
1-phase kit	 <p>Incl. transducer XB-31010, mounting kit XB-51010</p>	X	X	X	X	XB-71010
3-phase kit	Incl. 3 x 1-phase kits XB-71010	X	X	X		XB-71013
Digital						
1-phase kit	 <p>Including: Transducer XB-39130 Mounting kit XB-51010 With Cable, 10 m (33 ft)</p>	X				XB-71020
3-phase kit	Including: 3 x 1-phase kits XB-71020	X				XB-71023
1-phase kit	 <p>Including: Transducer XB-39131 Mounting kit XB-51010 With Cable, 10 m (33 ft)</p>	X				XB-71026
3-phase kit	Including: 3 x 1-phase kits XB-71026	X				XB-71027

Circuit breaker specific kits

Item	Description	TM17/1800	EGIL200	TM1600	EGIL	Part No.
Transducer mounting accessories						
Holder for transducer 	Holder for dig. rotary Baumer EIL and linear LWG, Ø 36 mm	X	X	X	X	XB-39005
Switch magnetic base 	For easy attachment of transducer mounting arrangements. Equipped with threaded hole suited for a "Flexible arm".	X	X	X	X	XB-39013
Clamping base 	Clamp suited for a "Flexible arm" Jaw opening max 40 mm	X	X	X	X	XB-39014
Flexible arm 	M8 bolt threads at the ends of the arms	X	X	X	X	XB-39021
Holder for transducer 	Holder for rotary transducers: Novotechnik IP6501 analog and Baumer BDH digital, Ø 55 mm	X	X	X	X	XB-39022
Universal support 	Suited for the "Flexible arms". Rod length is 250 mm Jaw opening max 40 mm	X	X	X	X	XB-39029
Flex coupling 	For shaft diam. 6 mm (for Novotechnik IP6501)	X	X	X	X	XB-39030
Flex coupling 	For shaft diam. 10 / 6 mm (for Baumer BDH and EIL)	X	X	X	X	XB-39032

Item	Description	TM17/1800	EGIL200	TM1600	EGIL	Part No.
<p><i>Thread adapter kit</i></p> 	<p>Imperial / metrics adapter kit for TLH</p> <p>Including:</p> <ul style="list-style-type: none"> 1 nut metrics, M5 1 spacer nut, M5 / UNF 10-32 1 spacer nut, M5 / UNC 1/4-20 1 nut, UNF 10-32 1 nut, UNC 1/4-20 	X	X	X	X	XB-39036
<p><i>Magnetic adapter for motion transducer fitting.</i></p> 	<p>For attaching rotary transducers on shaft ends. Ideal at first trip test when other mechanical attachment methods are impracticable. Fits to a Ø 6 mm flex coupling. Super strong neodymium magnet. Fits with both resistive and incremental rotary transducers</p>	X	X	X	X	XB-39037
<p><i>Holder for TS transducer</i></p> 	<p>For TS Transducer 18 mm</p>	X	X	X	X	XB-39512

Item	Description	TM17/1800	EGIL200	TM1600	EGIL	Part No.
Other						
<i>Dolphin clamps</i>	 <p>Black, with connection for 4 mm banana plug</p>	X	X	X	X	40-08320
	 <p>Red, with connection for 4 mm banana plug</p>	X	X	X	X	40-08322
<i>Timing clamp</i>	 <p>Timing clamp for bolt head</p>	X	X	X	X	53-31800
<i>Cable organizer</i>	 <p>Hook-and-loop straps, 10 pcs.</p>	X	X	X	X	AA-00100
<i>VD401</i>	 <p>Voltage divider, ratio 400/1 (for TM1600 and EGIL with analog channel)</p>			X	X	BL-90070
<i>USB to fiber adapter</i>	 <p>CABA Hardware USB to fiber adapter</p>			X		BL-90165
<i>Current clamp</i>	 <p>AC/DC current clamp, 10 A, 100 mV / A, 100 A, 10 mV / A. Incl. BNC to XLR adapter GA-00140</p>	X	X	X	X	BL-90600
	<p>Pack of three BL-90600</p>	X	X	X	X	BL-90610
<i>Current clamp for static resistance measurement on GIS circuit breakers with DualGround</i>	 <p>AC/DC current clamp S.C 200/1, 5 mV / A</p>	X				XA-12992

Item	Description	TM17/1800	EGIL200	TM1600	EGIL	Part No.
Multi purpose current clamps	 Current Probe 30A DC/AC 100 mV/A 100 kHz Recommended accessory, BNC to XLR adapter (GA-00140)	X	X	X	X	XA-11000
Multi purpose current clamps	 Current Probe 30/300A DC/AC 10/1 mV/A 20 kHz Recommended accessory, BNC to XLR adapter (GA-00140)	X	X	X	X	XA-11620
Breaker Simulator BRS503	 Breaker simulator incl. power supply 24 V/1 A. For product training and demo purpose. Runs together with all Megger circuit breaker analyzers. Pedagogic design 1 break / phase, Main and PIR contacts Two Auxiliary contacts Analog and Digital motion outputs Breaker status indication Realistic coil currents Connection guide included	X	X	X	X	BL-97390
Temperature sensor	 With the temperature sensor the ambient temperature is automatically recorded with each measurement and stored together with the test result. The temperature becomes a parameter in CABA Win. Suitable cable is the Analog cable, 10 m (GA-01005). Range: -20°C to +50°C (-4°F to +122°F) Resolution: 0.5°C (0.9°F)	X ⁴⁾				CG-90070
Thermopaper	 114 mm, 30 m		X	X	X	GC-00100
Thermopaper	 Box/24 pcs		X	X	X	GC-00140
Thermopaper	 114 mm, Ø 40 mm		X ⁵⁾			GC-00110
Soft case	 Made from sturdy nylon fabric	X				GD-00315
Cable and accessories bag	 With backpack straps and hand straps. Variable height through zipper solution. Dimensions 580x355x165/228 mm (23" x 14" x 6.5/9")	X	X	X	X	2012-180

⁴⁾ Only for TM1800

⁵⁾ Only for TM1800

Item	Description	TM17/1800	EGIL200	TM1600	EGIL	Part No.
Cable case	 <p>Cable case soft with 11 compartments With shoulder strap and two handles Made from sturdy nylon fabric Dimensions: 740 x 270 x 420 mm Note: No cables included</p>	X		X	X	GD-31055
Clamp						
Clamps	 <p>Multipurpose kelvin clamp for timing and low resistance measurement, black, 4 mm banana socket.</p>	X	X	X	X	KD-03040
Clamps	 <p>Multipurpose kelvin clamp for timing and low resistance measurement, red, 4 mm banana socket.</p>	X	X	X	X	XB-39302
Ferrite kit, clip-on, with protective cover	 <p>Accessory for timing of GIS circuit breakers using TM1800, TM1700, EGIL200 with DualGround™ Including: C-shape ferrite clip with clips 4 XB-40040 C-shape ferrite 4 XB-40050 I-shape ferrite 4 XB-40060 Round ferrite 4 30-67090 Transport case GD-00440 User Guide ZP-CG04E</p>	X	X			XB-39590
Ferrite C-shape, protective cover, clips	 <p>Width: 37.5 mm (1.5")</p>	X	X			XB-40040
Ferrite C-shape, protective cover	 <p>Width: 37.5 mm (1.5")</p>	X	X			XB-40050
Ferrite I-shape, protective cover	 <p>Width: 37.5 mm (1.5")</p>	X	X			XB-40060
Ferrite kit, Velcro attachment, w/o protective cover	 <p>Accessory for timing of GIS circuit breakers using TM1800, TM1700, EGIL200 with DualGround™ Including: C-shape ferrite 7 XB-40010 I-shape ferrite 4 XB-40020 Round ferrite 4 30-67090 Hook and loop fastener 4 09-10140 Transport case GD-00440 User's Manual ZP-CG04E</p>	X	X			XB-40090

Item	Description	TM17/1800	EGIL200	TM1600	EGIL	Part No.		
Ferrite kit with slim I-shape ferrites, Velcro attachment, w/o protective cover		Accessory for timing of GIS circuit breakers using TM1800, TM1700, EGIL200 with DualGround™ Including: C-shape ferrite 7 XB-40010 I-shape slim ferrite (w. 25mm) 4 XB-40030 Round ferrite 4 30-67090 Hook and loop fastener 4 09-10140 Transport case GD-00440 User's Manual ZP-CG04E				X	X	XB-40095
Ferrite I-shape slim		Width: 25 mm				X	X	XB-40030
C-shape ferrite		Width				X	X	XB-40010
I-shape ferrite		Width				X	X	XB-40020
Round ferrite		Width				X	X	30-67090

Ferrites Dimensions

C-shape ferrite

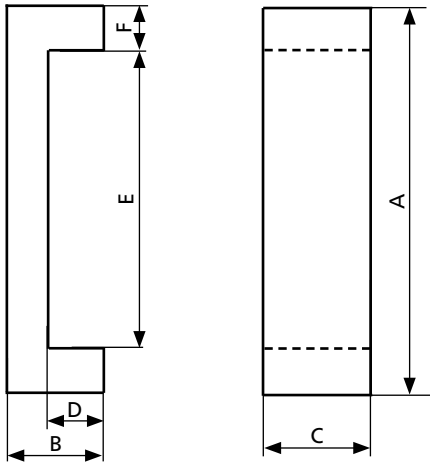

- A 102 mm (4.0")
- B 20.5 mm (0.8")
- C 37.5 mm (1.5")
- D 13 mm (0.5")
- E 85 mm (3.3")
- F 8 mm (0.3")

Note: Measures does not include hook and loop fastener

I-shape ferrites

Two versions, one included in the Ferrite kit and a slimmer one as an optional accessory.

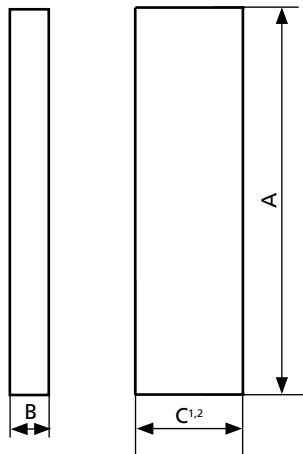

- A 102 mm (4")
- B 7.5 mm (0.3")
- C¹ 37.5 mm (1.5")
- C² 25 mm (1.0") Note: Optional accessory

Note: Measures does not include hook and loop fastener

Round ferrite

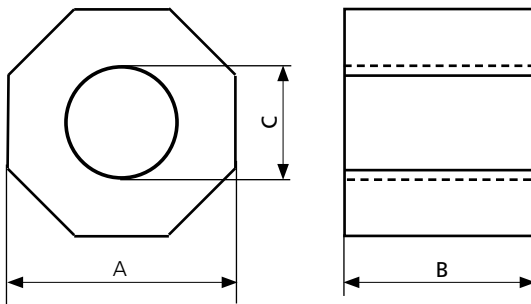

- A 55.5 mm (2.2")
- B 43 mm (1.7")
- C 26 mm (1.0") Max. cable diam. 25.4 mm (1")

Hook and loop fastener

26 X 290 mm (1.02 X 11.4")

Transport case

390 x 310 100 mm (15.4" x 12.2" x 3.9")
4.5 kg (9.9 lbs)
total kit including transport case

C-shape ferrite

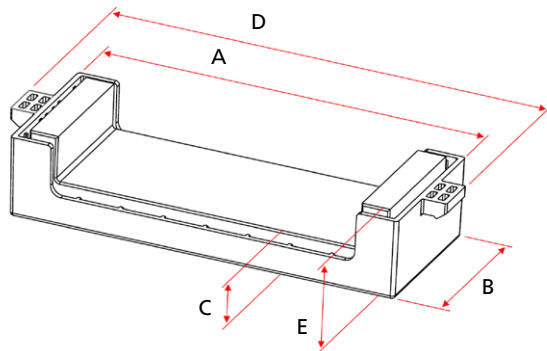

- A 111 mm (4.4")
- B 44 mm (1.7")
- C 11 mm (0.4")
- D 125 mm (4.9")
- E 24 mm (0.9")

C-Shape Clip ferrite

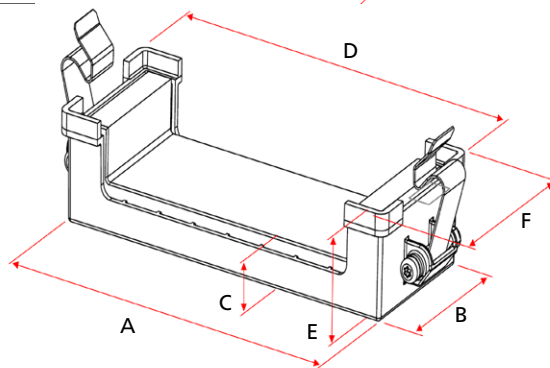

- A 111 mm (4.4")
- B 44 mm (1.7")
- C 11 mm (0.4")
- D 115 mm (4.6")
- E 27 mm (1.1")
- F 49 mm (1.9")

C+C-shape-mounted ferrite

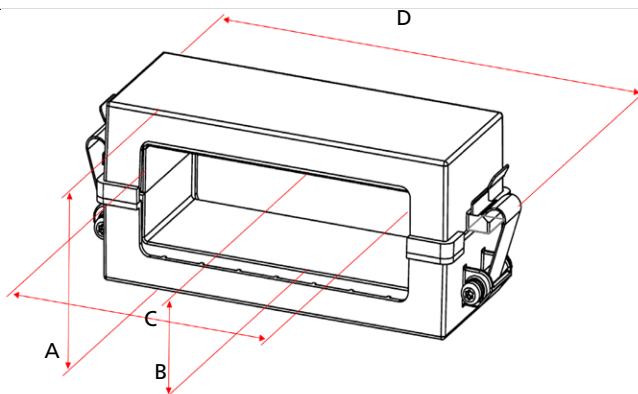

- A 48 mm (1.9")
- B 26 mm (1.0")
- C 85 mm (3.3")
- D 133 mm (5.2") (Over all length including clips)

I-Shape ferrite

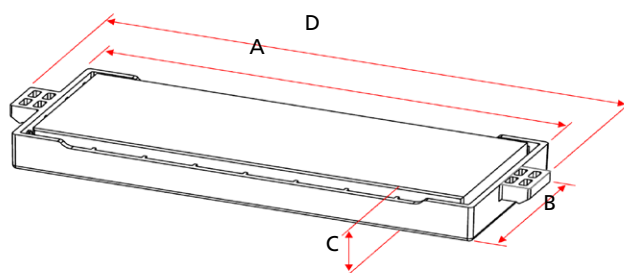

- A 111 mm (4.4")
- B 44 mm (1.7")
- C 11 mm (0.4")
- D 125 mm (4.9")

C+I-shape mounted ferrite

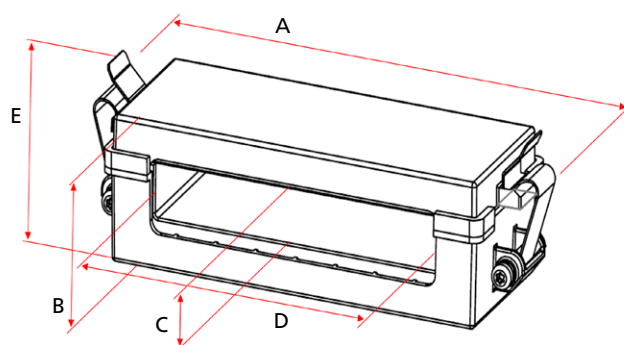

- A 133 mm (5.2") (Over all length including clips)
- B 35 mm (1.4")
- C 13 mm (0.5")
- D 85 mm (3.3")
- E 40 mm (1.6") (Over all height including clips)

Transducer mounting examples

Transducer mounting examples

Analog transducer mounted on a distribution circuit breaker

1. Clamping base
2. Flexible arm
3. Holder angular transducer
4. Novotechnik IP6501
5. Flex coupling
6. Bolt adapter

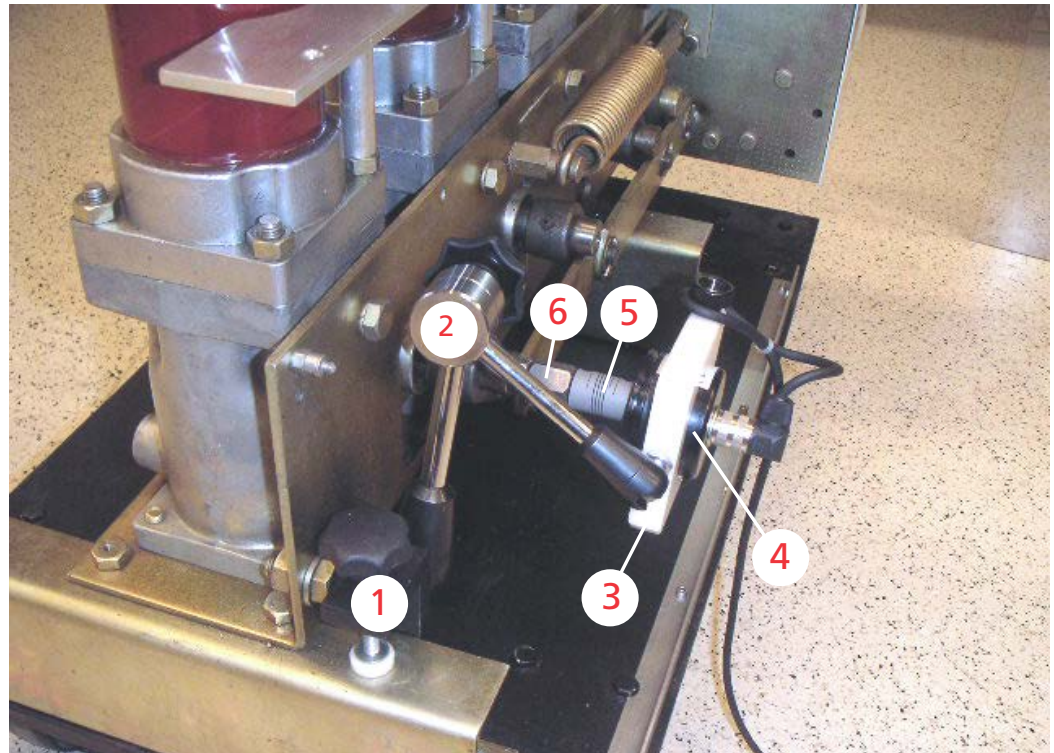

Analog transducer mounted on a distribution circuit breaker

1. Magnetic base
2. Flexible arm
3. Holder angular transducer
4. Novotechnik IP6501
5. Flex coupling
6. Bolt adapter

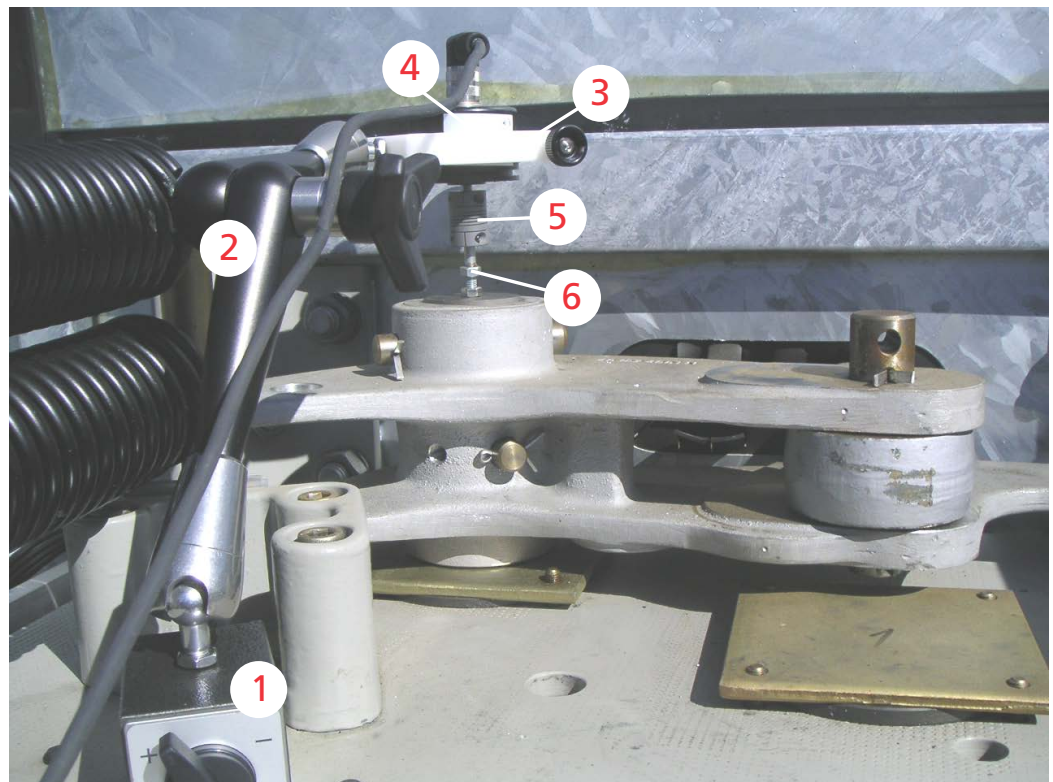

Factory

Megger Sweden AB
Rinkebyvägen 19
SE182 36 Danderyd
Sweden

Sales offices

Megger Turkey
Megger Elektrik Sistemleri
Test Hizmetleri ve Ticareti LTD.
Şti. Yaşamkent Mahallesi 3061.
Cadde No: 64 Çankaya
ANKARA

Megger
Millennium Tower
9th Floor, Office No. 142,
Bldg. No. 205, Road 2803,
King Mohammed IV Avenue
Block No. 428, Seef Area
Bahrain

Megger Suzhou
Room 3002-3005
Building 38
TusCity, Suzhou Industrial Park
PRC, China

Megger HK
Workshop No. 5, 16/F
Mega Trade Centre
1-6 Mei Wan St
Tsuen Wan
Hong Kong

Megger s.r.o.
Budečská 18/1010
120 00 Praha 2
Czech Republic

Megger Sp.z o.o
Stara Iwiczna
aul.Słoneczna 42A
05-500 Piaseczno
Poland

Megger France
9 rue Mickaël Faraday
78180
Montigny-le-Bretonneux
France

Megger India Private Limited
Blue Wave, 3rd Floor
Plot No: C22 & C23
Off Link Road
Behind Kuber Chambers
Andheri W, Mumbai
400053, India

Megger s.r.o.
Rožňavská 12
821 04 Bratislava
Slovakia

Megger Instruments
S.L.Calle Pedrezuela, 21A
NAVE 12, Polígono industrial
Ventorro del Cano
28925, Alcorcón
Madrid, Spain

Megger Limited
Unit 106-550 Alden Road
Markham
Ontario
L3R 6A8
Canada

Megger Sweden AB
Box 724
SE-182 17 DANDERYD
SWEDEN

www.megger.com

Megger[®]

CB-Testing-Accessories_BR_en_V10a

The word 'Megger' is a registered trademark. Copyright © 2023