



DCM340 Clampmeter

User Guide

1. Safety Information

To ensure safe operation and service of the Meter, follow these instructions.

Failure to observe warnings can result in severe injury or death.

- Avoid working alone so assistance can be rendered.
- To enhance safety, test leads should be disconnected from instrument when not in use.
- Do not use test leads or the Clamp Meter if they look damaged.
- Do not use the Meter if the Clamp Meter is not operating properly or if it is wet.
- Use the Clamp Meter only as specified in the Instruction card or the protection provided by the Clamp Meter might be impaired.
- Special precautions are necessary when operating in situations where exposed live parts at dangerous voltages may be encountered. Personal protective equipment (not supplied with this instrument) should be used.
- The test leads should be disconnected from the instrument when making a current measurement.
- Use caution with voltages above 30 V ac rms, or 60 V dc. These voltages pose a shock hazard.
- To avoid false readings that could lead to electric shock and injury, replace the battery as soon as the low battery indicator () appears.

CAUTION :

CAUTION : If the meter is used in the vicinity of equipment which generates electromagnetic interference, the display may become unstable or the measurements show may be subject to large errors.

1.1 Maintenance

Do not attempt to repair this Clamp Meter.











It contains no user-serviceable parts. Repair or servicing should only be performed by qualified personal.

1.2 Cleaning

Periodically wipe the case with a dry cloth and detergent do not use abrasives or solvents.

1.3 Safety, Hazard and Warning symbols on the instrument

This paragraph details the various safety and hazard icons on the instrument's outer case.

Icon	Description
	Warning: High Voltage, risk of electric shock
	Caution: Refer to user guide.
	UK conformity. This equipment complies with current UK legislation
	EU conformity. Equipment complies with current EU directives.
	Equipment complies with current 'C tick' requirements.
	Do not dispose of in the normal waste stream.
	Equipment protected throughout by double insulation.
	AC measurement
	DC measurement
	Reference earth connection. Not a protective earth terminal
	Battery

CAT IV - Measurement category IV: Equipment connected between the origin of the low-voltage mains supply and distribution panel.

CAT III - Measurement category III: Equipment connected between the distribution panel and electrical outlets.

CAT II - Measurement category II: Equipment connected between the electrical outlets and user's equipment.

CAT I - Measurement category I: The circuits are not connected to mains.

Measurement equipment may be safely connected to circuits at the marked rating or lower. The connection rating is that of the lowest rated component in the measurement circuit.

2. Operation

2.1 Power On / Off

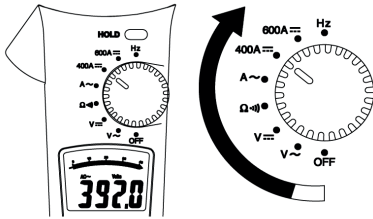

2.2 Auto Power Off

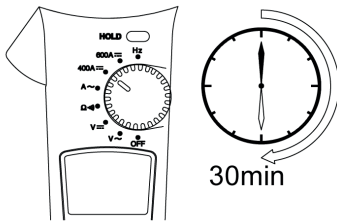

Auto Power Off disable : Press buttons (except Hold button) than switch the rotary knob to power on the Meter.

2.3 AC V / DC V

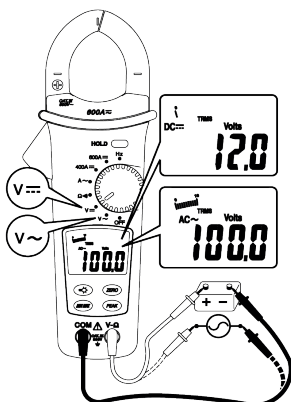

2.4 Resistance

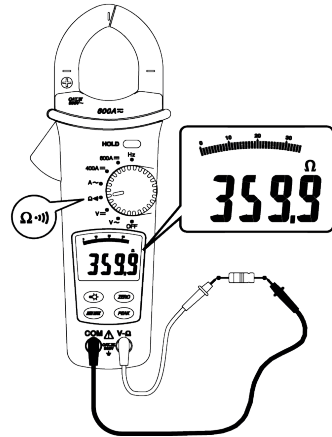

2.5 Continuity

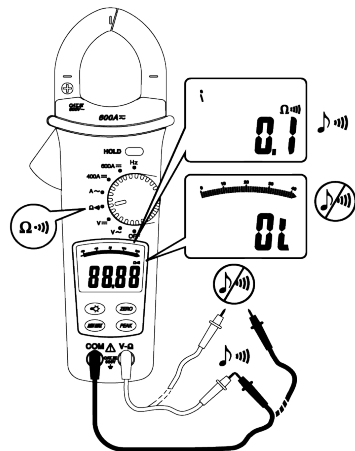

2.6 ACA / DCA

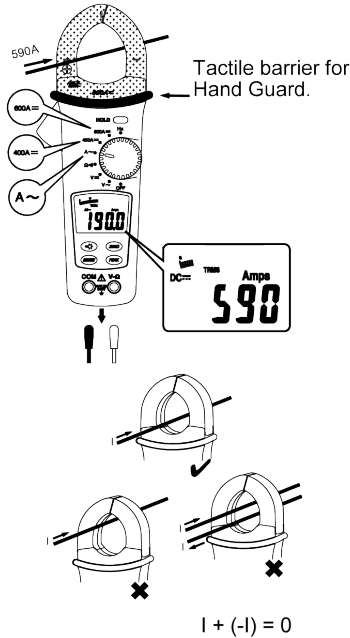

△ CAT.III.600 V with respect to earth for the jaw.

△ Do not hold the meter in front of the Tactile Barrier.

2.7 Hz

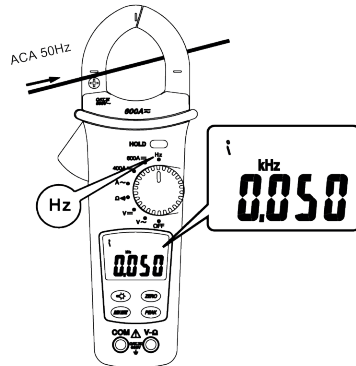

2.8 Zero

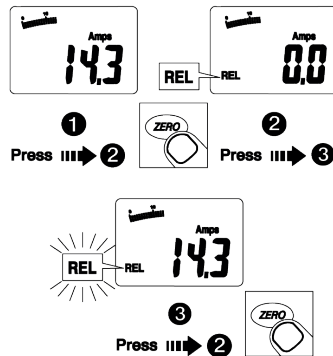

2: REL: Meter save the displayed offset value after one press of the ZERO button. The LCD is displaying the relative value.

3: REL (flashing): A second press of the ZERO button saves the offset value, with the present value then displayed.

1: Normal : Press and hold ZERO for ≥ 2 sec to return to normal operation and cancel the offset value.

2.9 Data Hold

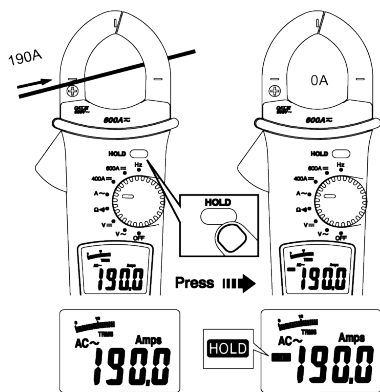

2.10 Min / Max Hold

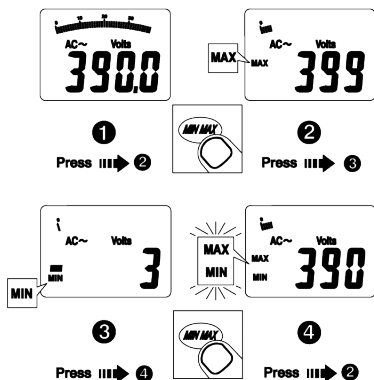

2: MAX: Meter is saving the maximum and minimum value. Maximum value is displayed

3: MIN: Meter is saving the maximum and minimum value. Minimum value is displayed

4: MAX MIN (flashing): Meter is saving the maximum and minimum values. Present value is displayed.

1: Normal : Press and hold MIN MAX to return to normal operation.

2.11 Battery Replacement

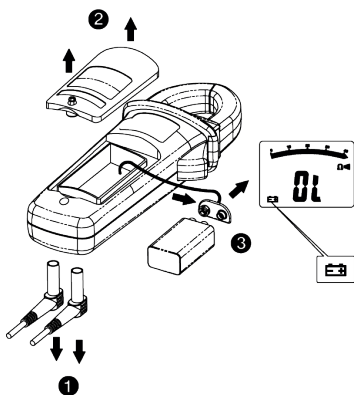

Low battery : “” is displayed or flashes when a button is pressed.

To avoid false readings that could lead to electric shock and injury, replace the battery as soon as the low battery indicator () appears.

2.12 Peak Hold

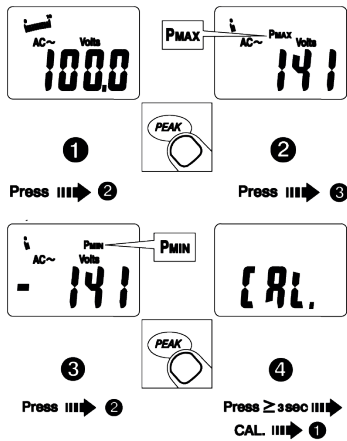

2: P MAX: Meter is saving the peak maximum and minimum value. Peak maximum value is displayed.

3: P MIN: Meter is saving the peak maximum and minimum value. Peak minimum value is displayed

4: CAL : Press and hold PEAK button ≥ 3 sec to calibrate the Meter itself for accurate measurement.

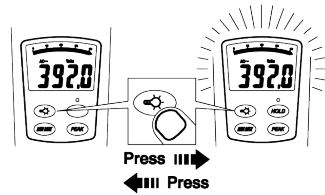

1: Normal : Press and hold PEAK button to return to normal operation.

2.13 Back Light



Back light Automatic off after 60 seconds.

3. Specifications

Specification	Detail
1-1 General Specifications	
LCD display digits :	3 3/4 digit large scale LCD readout.
Display count :	4000 counts.
Measuring rate :	1.5 times / sec.
Overrange display :	“OL” is displayed for “Ω” functions, shows the real value for “A” and “V” function.
Automatic power off time :	Approximately 30 minutes after
Low battery indicator :	 is displayed. Replace the battery when the indicator  appears in the display. To avoid false readings that could lead to electric shock and injury, replace the battery as soon as the low battery indicator appears.
Power requirement :	9 V PP3 / 6LR61 battery. Rechargeable batteries are not suitable for use with this instrument.
1-2 Environmental Conditions	
Indoor Use.	
Calibration :	One year calibration cycle.
Operating temperature :	0 °C ~ 30 °C (±80% RH) 30 °C ~ 40 °C (±75% RH) 40 °C ~ 50 °C (±45% RH)
Storage temperature :	-20 to +60 °C, 0 to 80% RH (batteries not fitted).
Overvoltage category :	IEC 61010-1 600 V CAT.III. CAT.III equipment is designed to protect against the transients in the equipment in fixed installations, such as distribution panels, feeders and short branch circuits and lighting systems in large buildings.
Operating altitude :	2000 m (6562 ft)
Conductor Size :	35 mm diameter.
Pollution degree :	2
EMC :	EN 61326-1
Shock vibration :	Sinusoidal vibration per MIL-T- 28800E (5 ~ 55 Hz, 3 g maximum).
Drop Protection :	1.2 m drop to hardwood on concrete floor.

1-3 Electrical Specifications

Accuracy is \pm (% reading + number of digits) at 23 °C \pm 5 °C < 80%RH.

Temperature coefficient : Add 0.2 x (Specified accuracy) / °C, < 18 °C, > 28 °C .

Voltage	Function	Range	Accuracy
	V \sim	0~400.0 Vrms 400~600 Vrms	\pm (1.0%+ 5 dgt) 50 Hz ~ 500 Hz
	V \equiv	0~400.0 V 400~600 V	\pm (0.7% + 2 dgt)

Over voltage protection : 600 V rms

Input Impedance : 1 M Ω // less than 100 pF.

AC Conversion Type : AC Conversion are average sensing rms indication calibrated to the rms value of a sine wave input.

Resistance and Continuity :	Function	Range	Accuracy
	Ω	400.0 Ω	\pm (1% + 3 dgt)

Over voltage protection : 600 V rms

Max. open circuit voltage : 3 V

Continuity check : Internal sounds activates if the resistance of the circuit under test is less than 30 Ω approximately.

AC Current	Function	Range	Accuracy
	A \sim (50~60 Hz)	0~400.0 A	\pm (1.5%+ 5 dgt) *1
		400~600 A	\pm (2.0%+ 7 dgt)
	A \sim (61~400 Hz)	0~400.0 A	\pm (2.0%+ 5 dgt) *1
400~600 A		\pm (2.5%+ 7 dgt)	

*1 : Over 80% of full scale add \pm 1.6%

Overload protection : 600 A rms
AC Conversion Type and additional accuracy is same as AC Voltage.

Position Error : \pm 1% of reading.

DC Current	Function	Range	Accuracy
	A \equiv	0~400.0 A	\pm (1.2%+ 5 dgt)
		400~600 A	\pm (1.9%+ 7 dgt)

Overload protection : 600 A rms

Position Error : \pm 1% of reading.

Specifications

Addition error according to remanence :	1% max. of current crest.		
Auto Power Off (APO)	The meter will automatically shut itself off after approximately 30 minutes after power on.		
Frequency : Hz	Function	Range	Accuracy
	20~400 Hz	1 Hz	$\pm(0.1\% + 2 \text{ dgt})$
Overload protection :	600 A rms.		
Sensitivity :	3 A rms for ACA (A~) (>400 Hz Unspecified)		
Peak Hold :	$\pm(3\% + 15\text{dgt})$ *>600 Vpeak Unspecified. *>600 A peak Unspecified.		
Min/Max Hold :	add $\pm 15 \text{ dgt}$ to accuracy for ACA / DCA. * Automatically switch to the low resolution range at Peak Hold and MIN MAX Hold.		

4. Limited Warranty

This Meter is warranted to the original purchaser against defects in material and workmanship for 1 year from the date of purchase. During this warranty period, manufacturer will, at its option, replace or repair the defective unit, subject to verification of the defect or malfunction.

This warranty does not cover , disposable batteries, or damage from abuse, neglect, accident, unauthorized repair, alteration, contamination, or abnormal conditions of operation or handling.

Any implied warranties arising out of the sale of this product, including but not limited to implied warranties of merchantability and fitness for a particular purpose, are limited to the above. The manufacturer shall not be liable for loss of use of the instrument or other incidental or consequential damages, expenses, or economic loss, or for any claim or claims for such damage, expense or economic loss. Some states or countries laws vary, so the above limitations or exclusions may not apply to you.

4.1 Decommissioning

4.2 WEEE Directive

The crossed out wheeled bin symbol placed on Megger products is a reminder not to dispose of the product at the end of its life with general waste.

Megger is registered in the UK as a Producer of Electrical and Electronic Equipment. The Registration No is WEE/ HE0146QT.

For further information about disposal of the product consult your local Megger company or distributor or visit your local Megger website.

4.3 Battery disposal

The crossed out wheeled bin symbol placed on a battery is a reminder not to dispose of batteries with general waste when they reach the end of their usable life.

For disposal of batteries in other parts of the EU contact your local Megger branch or distributor.

Megger is registered in the UK as a producer of batteries (registration No.: BPRN00142).

For further information see www.megger.com

Manufacturing sites

Megger Limited
Archcliffe Road
Dover
Kent
CT17 9EN
ENGLAND
T. +44 (0)1 304 502101
F. +44 (0)1 304 207342

Megger GmbH
Weststraße 59
52074 Aachen
T. +49 (0) 241 91380 500
E. info@megger.de

Megger USA - Valley Forge
Valley Forge Corporate Center
2621 Van Buren Avenue
Norristown
Pennsylvania, 19403
USA
T. +1 610 676 8500
F. +1 610 676 8610

Megger USA - Dallas
4545 West Davis Street
Dallas TX 75237
USA
T. 800 723 2861 (USA only)
T. +1 214 333 3201
F. +1 214 331 7399
E. USsales@megger.com

Megger AB
Rinkebyvägen 19, Box 724,
SE-182 17
DANDERYD
T. +46 08 510 195 00
E. seinfo@megger.com

Suite 100
Fort Collins CO 80525
USA
T. +1 970 282 1200

Megger USA - Fort Collins
4812 McMurry Avenue

The company reserves the right to change the specification or design without prior notice.

Megger is a registered trademark