



MET1000

All in One True RMS Electrical Tester

User Guide

Register →
megger.com/register



Support →
megger.com/support



This document is copyright of:

Megger Limited, Archcliffe Road, Dover, Kent CT17 9EN. ENGLAND
T +44 (0)1304 502101 F +44 (0)1304 207342 www.megger.com

Megger Limited reserves the right to alter the specification of its products from time to time without notice. Although every effort is made to ensure the accuracy of the information contained within this document it is not warranted or represented by Megger Limited to be a complete and up - to - date description.

For Patent information about this instrument refer to the following web site:

megger.com/patents

This manual supersedes all previous issues of this manual. Please ensure that you are using the most recent issue of this document. Destroy any copies that are of an older issue.

Declaration of Conformity

Hereby, Megger Instruments Limited declares that radio equipment manufactured by Megger Instruments Limited described in this user guide is in compliance with Directive 2014/53/EU. Other equipment manufactured by Megger Instruments Limited described in this user guide is in compliance with Directives 2014/30/EU and 2014/35/EU where they apply.

The full text of Megger Instruments EU declarations of conformity are available at the following internet address













megger.com/company/about-us/eu-dofc

Safety Information

To ensure safe operation and service of the meter, follow these instructions. Failure to observe warnings can result in severe injury or death.

- If the equipment is used in a manner not specified by the manufacturer, the protection provided by the equipment may be impaired.
- Always use the proper terminals, switch position, and range for measurements.
- Ensure hands are kept behind the barrier / hand guard when making measurements
- To reduce the risk of fire or electric shock, do not use this product around explosive gas or in damp locations.
- Verify the Meter operation by measuring a known voltage. If in doubt, have the meter calibrated.
- Do not apply more than the rated voltage, as marked on meter, between terminals or between any terminal and earth.
- Avoid working alone.
- Do not use the tester if the tester is not operating properly or if it is wet.
- Personal protective equipment must be used if hazardous live parts in the installation where the measurement is to be carried out could be accessible.
- Use caution with voltages above 30 VAC rms, 42 VAC peak, or 60 VDC. These voltages pose a shock hazard.
- DO NOT USE the test leads if the internal white insulation layer becomes exposed.
- DO NOT USE the test leads for voltage or current measurement in any environment above the safety CAT rating printed on the probe or probe tip guard cap
- DO NOT USE the test leads without the probe tip guard cap in CAT III or CAT IV environments.
- Probe assemblies to be used for mains measurements shall be rated as appropriate for measurement Category III or IV according to IEC 61010-031 and shall have a voltage rating of at least the voltage of the circuit to be measured.
- Disconnect circuit power and discharge all high-voltage capacitors before testing resistance, continuity.
- When connecting test leads to the instrument ensure the 4mm plugs are fully inserted into the terminals.

Symbols as marked on the Meter and Instruction manual

Symbol	Explanation
	Risk of electric shock
	See instruction manual
	DC measurement
	AC measurement
	Both direct and alternating current
	Equipment protected by double or reinforced insulation
	Battery
	Earth
	UK conformity. This equipment complies with current UK legislation
	EU conformity. Equipment complies with current EU directives
	Application around and removal from hazardous live conductors
	Do not discard this product or throw away

CATIV: Measurement category IV: Equipment connected between the origin of the low-voltage mains supply outside the building and the consumer unit.

CATIII: Measurement category III: Equipment connected between the consumer unit and the electrical outlets.

CATII: Measurement category II: Equipment connected between the electrical outlets and the user's equipment.

Making Basic Measurements

Observe all Warnings and Cautions before measurements.

CAUTION

- When connecting the test leads to the device under test connect the common test leads before connecting the live test lead. When removing the test leads, remove the live test lead before removing the common test lead.
- Make sure that the buzzer sound is perceptible before using it under high background noise environment.

Voltage/Continuity/Single Pole Mode

Voltage/Continuity/Single Pole Mode

Voltage Measurement

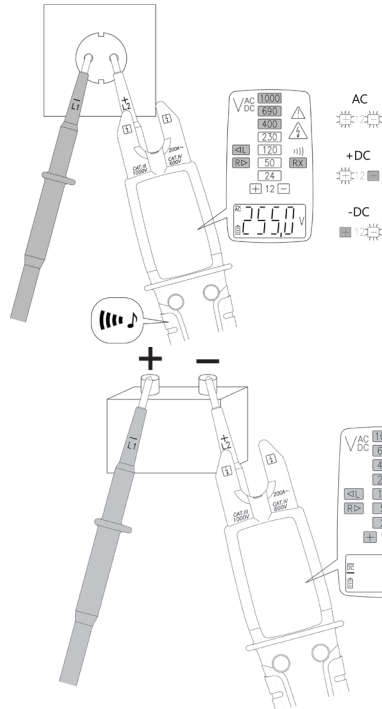

LED  indicates measured voltage is high than ELV limit (50 VAC and/or 120 VDC).

Warning

- When batteries are not fitted or are exhausted, the tester is capable of measuring >45 VAC and/or >35 VDC.
- Timing Rating (tr): 30 seconds, Recovery Time (rt): 240 seconds, when measuring >300 V, recovery time is necessary.
- L/R LED may light up when measuring AC voltage.
- Due to the high internal resistance, capacitive and inductive voltage (ghost voltage) may be indicated.
- Ensure test leads are fully inserted prior to making any measurement.

Continuity Check

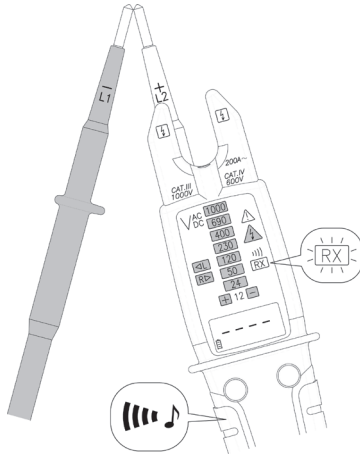

Voltage/Continuity/Single Pole Mode

Single Pole Phase Check

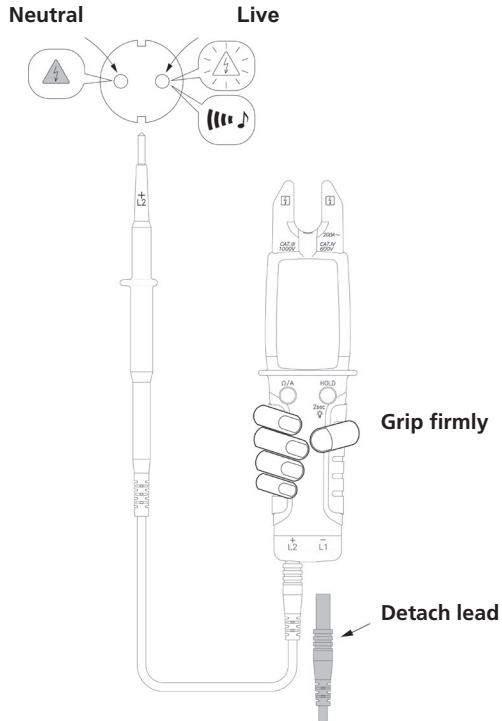

Warning

- The MET1000 Single Pole Check feature consists of using only one test lead connected to the MET1000, remove second test lead if fitted.
- To carry out Single Pole Check test, while firmly holding the MET1000 connect the test lead into a live circuit, this will cause the MET1000 to repeatedly beep and the hazard symbol to illuminate without any voltage being displayed on the screen.
- If a voltage appears on the screen then use 2 Pole method to prove the circuit live.
- Ensure test leads are fully inserted prior to making any measurement.

Phase Rotation Test

Clockwise Phase Sequence L1-L2-L3 (Right)

Source Terminal

L1 — L1
L2 — L2
L3 — L3

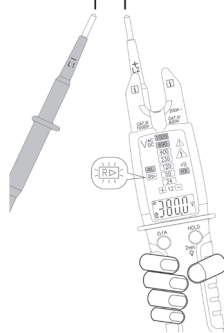

Grip firmly

Counter-clockwise Phase Sequence L1-L3-L2 (Left)

Source Terminal

L1 — L2
L2 — L1
L3 — L3

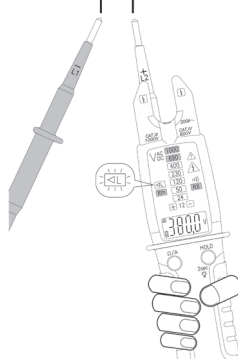

Grip firmly

⚠ Warning

Phase Rotation Test works only on 3 phase 4 wire systems. The result is unreliable on any other systems.

⚠ Note

It maybe necessary to check the result by testing in reverse sequence.

Resistor Mode

Resistor Mode

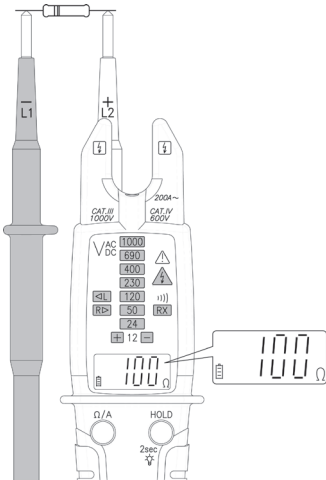

Current Mode

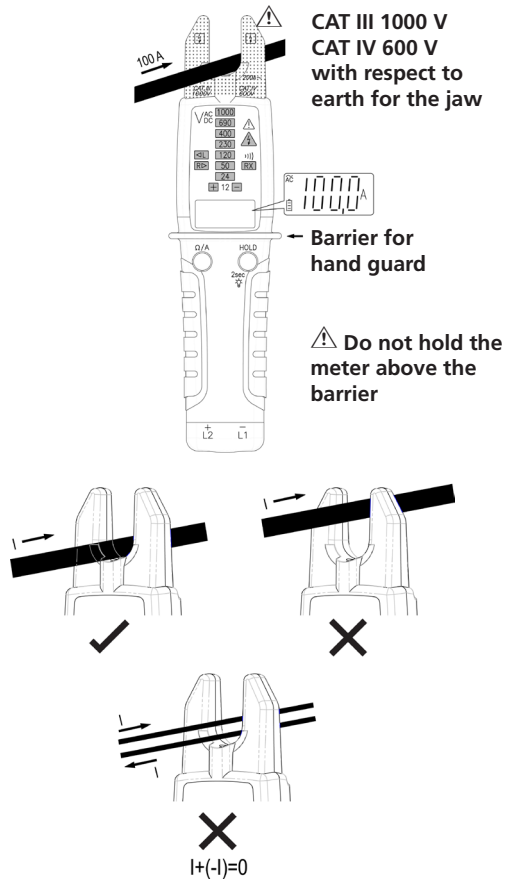

⚠ Warning

The barrier guard on the meter provides maximum protection when holding the unit in normal use.

⚠ Warning

Remove the test leads from the back of the meter when measuring current.

Using the Functions

Using the Functions

HOLD

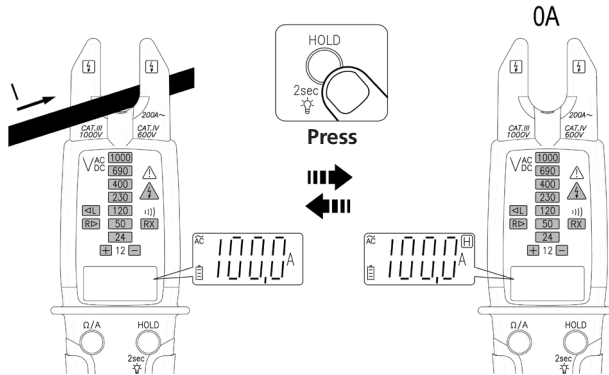

Enable/Disable ELV Warning

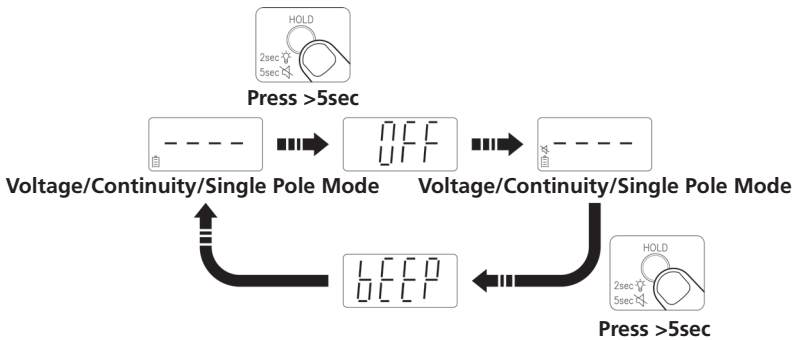

Press Ω/A button and "HOLD" button at the same time.

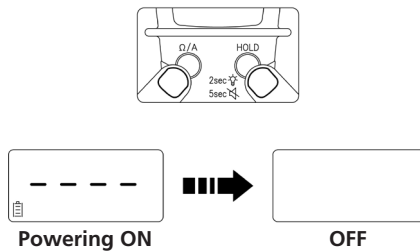

Torch

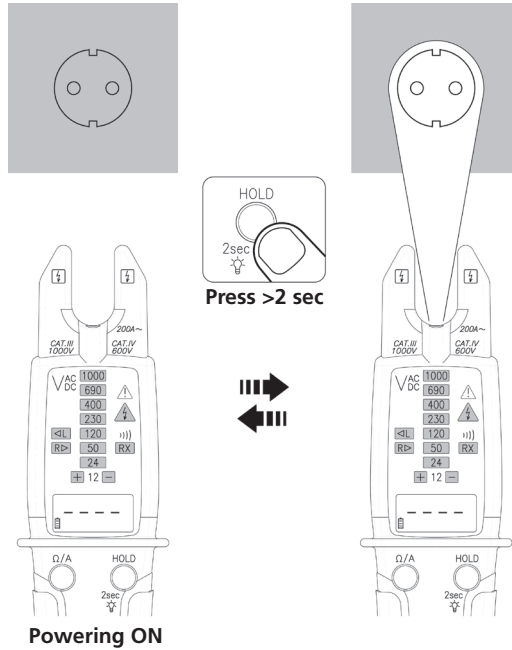

Self-diagnostic test

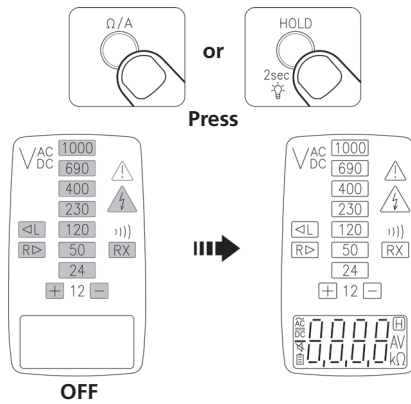

Warning

Do not use the tester if a fault is indicated during self-diagnostic test.

Using the Functions

Function Button

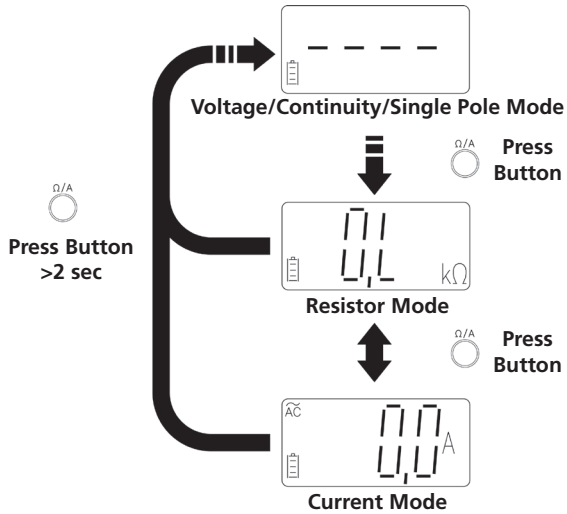

Battery Replacement

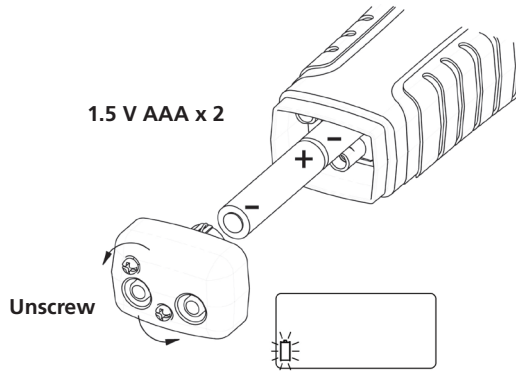

Warning

- Replace the batteries as soon as the low battery indicator starts to flash to avoid false readings.
- Remove test leads from meter before opening the battery cover.

Probe Usage

Probe Usage

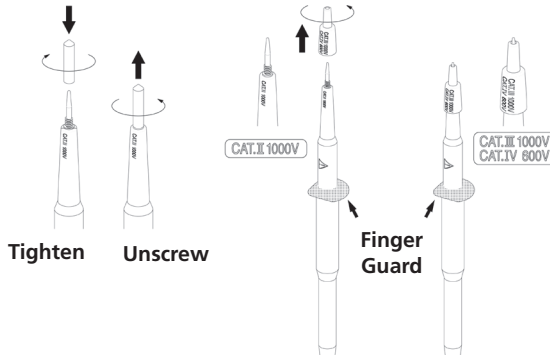

Warning

When using test leads or probes, keep your fingers behind the finger guards.

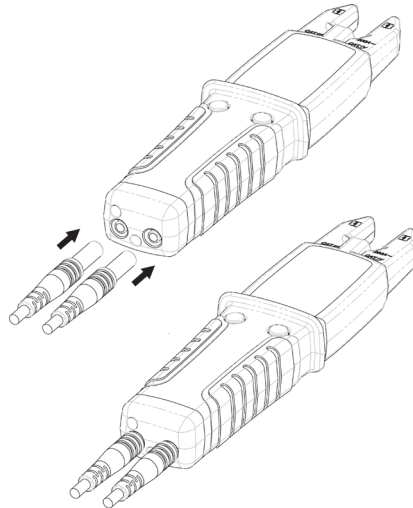

Warning

- For CAT III or CAT IV environments, use the test leads with the probe tip guard cap fixed firmly in place. Without the probe tip guard cap the test leads can ONLY be used in a CAT II environment.
- Make sure the test leads are firmly inserted in the instrument and other accessories are connected securely before making any measurement.

Test lead assembly

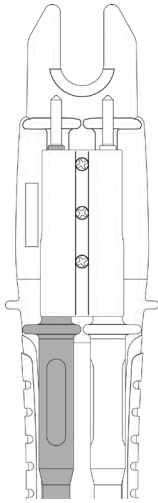

Lead storage

 **Warning**

Do not attach test leads onto the back of the meter while measuring current.

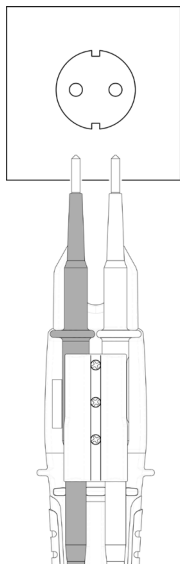

For 19 mm power socket

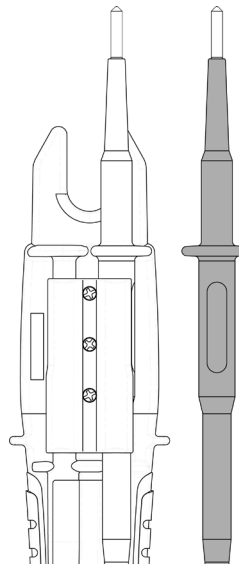

For most applications except current measurement.

Specifications

Specifications

Display count :	10,000 counts.
Overrange display :	« OL » or « -OL »
Conversion rate :	3 times per second
Dimensions (W x H x D) :	57 x 220 x 35 mm
Weight :	200 g
Power requirements :	AAA size battery x 2 (R03, LR03, 24D, 24A)
Battery life :	Approximately 1000 operations. (based on Alkaline batteries, 30 sec. ON, 240 sec. OFF)
Maximum Conductor Size :	16 mm diameter
Safety Standard Compliance :	IEC / EN 61010-1, IEC / EN 61010-2-032, IEC / EN 61010-2-033, IEC / EN 61010-031 for CAT IV 600 V, CATIII 1000 V IEC / EN 61326-1, IEC / EN 61243-3

Environmental Conditions

Indoor / Outdoor Use	
Pollution degree :	2
Maximum Operating Altitude :	2,000 m (6562 ft)
Operating Temperature & Relative Humidity :	
	-15 °C ~ 30 °C, ≤80 % RH. 30 °C ~ 40 °C, ≤75 % RH. 40 °C ~ 55 °C, ≤45 % RH.
Storage temperature :	-20 to +60 °C, 0 to 80 % RH. (no batteries)
Temperature coefficient :	0,2 x (specified accuracy) / °C, < 18 °C, > 28 °C
IP rating :	IP65
Vibration :	Random Vibration per MIL-PRF-28800F Class 2
Drop Protection :	1.2 m drop to hardwood on concrete floor

Electrical Specifications

Accuracy is given as \pm (% of reading + counts of least significant digit) at $23^{\circ}\text{C} \pm 5^{\circ}\text{C}$, with relative humidity less than 80% and is specified for 1 year after calibration.

Condition of Auto Power On

With batteries fitted :

- $> 3.0\text{ V}$ or $< -8.0\text{ V}$ between L2 and L1
- Detect AC signal by Single Pole
- Continuity

Without batteries :

$> |\pm 35,0\text{ V DC}|$ or $> 45.0\text{ V AC}$ between L2 and L1

Auto Power Off

The meter automatically turns off if one of the following conditions are met for approx 10 seconds:

- The Auto Power On condition is not met.
- Both buttons are not pressed.

The meter automatically turns off if one of the following conditions are met for approx 30 seconds:

- The resistance is OL when the meter is in resistor mode.
- The current is $< 1.0\text{ A}$ when the meter is in current mode

For $> 300\text{ V}$, Time rating (tr): 30 seconds; Recovery time (rt): 240 seconds

AC Function :

- ACV and ACA specifications are AC coupled, true RMS.
- For non-sinusoidal waveforms, Additional Accuracy by Crest Factor (C.F.):
Add 1.0% for C.F. 1.0 ~ 2.0
Add 2.5% for C.F. 2.0 ~ 2.5
Add 4.0% for C.F. 2.5 ~ 3.0
- Max. Crest Factor of Input Signal:
3.0 @ 5000 counts
1.5 @ 10000 counts

Specifications

Electrical Specification

DC Voltage

	Range	Resolution	Accuracy
With batteries	7.0 V to 999.9 V	0.1 V	±(1.0 % + 2D)
Without batteries(1)	35 V to 999.9 V	0.1 V	

(1) Measurement without batteries is only available for < 35°C, > -15°C. The meter will show "bAtt" and ELV LED when measurement is not available.

Max. Input Current : < 3,5 mA @ 1,000 V

Overload Protection : AC/DC 1,000 V

AC Voltage

	Range	Resolution	Accuracy
With batteries	6.0 V(1) to 999.9 V	0.1 V	±(1.5 % + 5D)
Without batteries(2)	45 V to 999.9 V	0.1 V	

(1) For > 65 Hz, the minimum range is 8.0 V

(2) Measurement without batteries is only available for < 35°C, > -15°C. The meter will show "bAtt" and ELV LED when measurement is not available

Frequency Response : 45 Hz to 400 Hz

Max. Input Current : < 3,5 mA @ 1 000 V

Overload Protection : AC/DC 1,000 V

Resistor

Range	Resolution	Accuracy
9999 Ω	1 Ω	±(1.5 % + 5D)
50.00 kΩ	0.01 kΩ	

Output Voltage : About 0.5 V

Overload Protection : AC/DC 1,000 V

Electrical Specification			
Continuity :	The built-in buzzer sounds when measuring resistance less than 1.8 k Ω and up to 2.7 k Ω . LED RX shows at the same time.		
Continuity Indicator :	2.7 kHz Tone Buzzer and RX LED		
Response Time of Buzzer :	< 100 ms		
Output Voltage :	About 0.5 V		
Overload Protection :	AC/DC 1,000 V		
AC Currant :			
	Range	Resolution	Accuracy
	200.0 A	0.1 A	$\pm(3.0 \% + 5D)$
Frequency Response :	45 Hz to 65 Hz		
Overload Protection :	AC/DC 200 A		
Rotary Field Indication :	For 3 phase 4 wire system only		
Sensitivity :	90 V to 1000 V (Phase-to-ground)		
Frequency Range :	45 Hz to 65 Hz		
"L" LED is on when the signal of L2 probe lead the signal of L1 probe; "R" LED is on when the signal of L1 probe lead the signal L2 probe.			
Single-Pole Phase Check			
Sensitivity :	90 V to 1000 V (Phase-to-Earth)		
Frequency Range :	45 Hz to 65 Hz		
Indicator :	2.7 kHz Tone Buzzer and ELV LED		

Maintenance

Maintenance

Do not attempt to repair this detector. It contains no user-serviceable parts. Repair or servicing should only be performed by qualified personnel.

Cleaning

Periodically wipe the case with a dry cloth and detergent, do not use abrasives or solvents.

WEEE Directive

The crossed out wheeled bin symbol on the instrument and on the batteries is a reminder not to dispose of them with general waste at the end of their life. Megger is registered in the UK as a Producer of Electrical and Electronic equipment. The registration No is; WEE/DJ2235XR. Users of Megger products in the UK may dispose of them at the end of their useful life by contacting B2B Compliance at www.b2bcompliance.org.uk or by telephone on 01691 676124. Users of Megger products in other regions should contact their local Megger office or distributor.

Battery Disposal

The batteries in this product are classified as Portable Batteries under the Batteries Directive. Please contact either Megger Ltd, your local Megger office or distributor for instructions on the safe disposal of these batteries. Megger is registered in the UK as a producer of batteries. The registration number is BPRN01235.

For further information see www.megger.com

Warranty (3 years)

This meter is warranted to the original purchaser against defects in material and workmanship for 3 year from the date of purchase. During this warranty period, the manufacturer will, at its option, replace or repair the defective unit, subject to verification of the defect or malfunction. This warranty does not cover fuses, disposable batteries, or damage from abuse, neglect, accident, unauthorised repair, alteration, contamination, or abnormal conditions of operation or handling.

Any implied warranties arising out of the sale of this product, including but not limited to implied warranties of merchantability and fitness for a particular purpose, are limited to the above. The manufacturer shall not be liable for loss of use of the instrument or other incidental or consequential damages, expenses, or economic loss, or for any claim or claims for such damage, expense or economic loss. Some states or countries laws vary, so the above limitations or exclusions may not apply to you.

Megger Limited
Archcliffe Road
Dover
Kent
CT17 9EN

Tel: +44 (0) 1304 502 101
Fax: +44 (0) 1304 207 342

www.megger.com



Local Sales office

Megger Limited
Archcliffe Road
Dover
Kent
CT17 9EN
ENGLAND

T. +44 (0)1 304 502101

F. +44 (0)1 304 207342

Manufacturing sites

Megger Limited
Dover, ENGLAND
T. +44 (0)1 304 502101
E. uksales@megger.com

Megger AB
Danderyd, SWEDEN
T. +46 08 510 195 00
E. seinfo@megger.com

Megger Valley Forge
Phoenixville, PA USA
T. +1 610 676 8500
E. USsales@megger.com

Megger USA - Dallas
Dallas, TX USA
T. +1 214 333 3201
E. USsales@megger.com

Megger USA - Fort Collins
Fort Collins, CO USA
T. +1 970 282 1200

Megger GmbH
Aachen, GERMANY
T. +49 (0) 241 91380 500
E. info@megger.de

Megger Germany GmbH
Baunach, GERMANY
T. +49 (0) 9544 68 - 0
E. baunach@megger.com

Megger Germany GmbH
Radeburg, GERMANY
T. +49 (0) 35208 84-0
E. radeburg@megger.com

This instrument is manufactured in Taiwan.

The company reserves the right to change the specification or design without prior notice.

Megger is a registered trademark

The Bluetooth® word mark and logos are registered trademarks owned by Bluetooth SIG, Inc and is used under licence.

MET1000_UG_EN_V04 6 February 2024 10:59 am

© Megger Limited 2024

www.megger.com