

Megger[®]

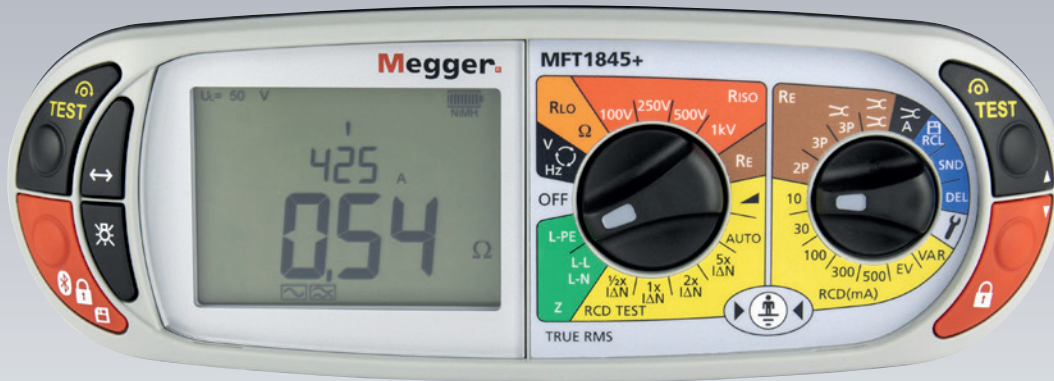

MFT1800 series

Multifunction testers

User Guide

This document is copyright of:

Megger Limited, Archcliffe Road, Dover, Kent CT17 9EN. ENGLAND
T +44 (0)1304 502101 **F** +44 (0)1304 207342 **www.megger.com**

Megger Limited reserves the right to alter the specification of its products from time to time without notice. Although every effort is made to ensure the accuracy of the information contained within this document it is not warranted or represented by Megger Limited to be a complete and up-to-date description.

For Patent information about this instrument refer to the following web site:

megger.com/patents

This manual supersedes all previous issues of this manual. Please ensure that you are using the most recent issue of this document. Destroy any copies that are of an older issue.



Declaration of Conformity



Hereby, Megger Instruments Limited declares that radio equipment manufactured by Megger Instruments Limited described in this user guide is in compliance with Directive 2014/53/EU. Other equipment manufactured by Megger Instruments Limited described in this user guide is in compliance with Directives 2014/30/EU and 2014/35/EU where they apply.

The full text of Megger Instruments EU declarations of conformity are available at the following internet address:

megger.com/eu-dofc

Contents

1. Safety	8
1.1. Safety Warnings	8
1.2. Live earth safety precautions	9
1.3. Symbols used on the instrument	10
2. Introduction	11
2.1. Overview	11
2.1.1. Front panel and controls	11
2.1.2. Display	12
2.1.3. Display symbols	12
2.1.4. Waste electrical and electronic equipment	13
2.1.5. Battery and fuse location, fitting and replacement	13
3. Operation	15
3.1. General operation – all models	15
3.1.1. Switching on	15
3.1.2. Switching off	15
3.1.3. Backlight	15
3.1.4. Test buttons	15
3.1.5. Test button lock	15
3.2. Mode button functions 	16
3.3. Test inhibit	17
3.3.1. Insulation	17
3.3.2. Continuity	17
3.3.3. Earth loop impedance	17
3.3.4. RCD/GFCI testing	17
3.3.5. Earth testing	17
3.3.6. Battery exhausted	17
4. Voltage, frequency, current and temperature measurement	18
4.1. Making a voltage measurement	18
4.2. Frequency measurement	19
4.3. Phase rotation	19
4.4. Leakage current measurement	19
4.5. Temperature measurement	19
4.6. Switch probe	20
5. Continuity / resistance measurement	21
5.1. Nulling test lead resistance (up to 9.99 ohms) 	21
5.2. Making a CONTINUITY measurement	22
5.3. Storing / downloading results	22
5.4. Continuity Buzzer ON/OFF	22
5.5. Switch probe (SP5)	23
5.6. Buzzer threshold	23
5.7. Measurement methods and sources of error	23

6. Insulation resistance ⁵⁰⁰V	24
6.1. Making an INSULATION measurement	24
6.2. Insulation test lock	25
6.3. Measurement methods and sources of error.....	25
7. Loop impedance testing	26
7.1. Range selection and test leads	26
7.1.1. Phase to earth L-E circuits.....	26
7.1.2. L-N or L-L circuits.....	28
7.1.3. Z, Zmax, Zref and R1+R2	28
7.2. Making a loop impedance measurement.....	28
7.2.1. Ze measurements at the origin (Phase to Earth).....	28
7.2.2. Zs and Zdb loop measurements without RCD - eg Zs, Zdb etc.....	29
7.2.3. Earth Loop measurements with an RCD in circuit.....	30
7.3. Phase to Neutral (all models) or Phase to Phase testing.....	32
7.4. Prospective Fault Current and Short Circuit calculation (PFC & PSCC)	33
7.5. Confidence Meter™ for non-trip (3Lo) loop impedance tests	34
7.5.1. Display information	34
7.5.2. 3Lo Loop Impedance Measurement	34
7.6. Measurement methods and sources of error.....	36
8. Residual Current Device (RCD) or Ground Fault Current Interrupt (GFCI) testing	37
8.1. Making an RCD measurement.....	38
8.2. Selecting RCD type	38
8.3. ½ x I RCD current rating (No-trip test) 	39
8.4. 1 x I RCD current rating (Tripping test on 30 mA RCD).....	40
8.5. 2 x I RCD Current Rating (Tripping test on 30mA RCD) (Not MFT1815)	41
8.6. 5 x I RCD current rating (Tripping test on 30 mA RCD).....	41
8.7. Ramp test 	42
8.8. Fast Ramp Test	42
8.9. Type A (DC Sensitive) RCD test 	42
8.10. Type B (Pure DC) RCD test (Not MFT1815)	43
8.11. Variable RCDs.....	44
8.12. AUTO RCD testing	44
8.13. 3 Phase RCD testing.....	45
8.14. Touch voltage display.....	45
8.15. Measurement methods and sources of error.....	46
8.16. Useful information	46
9. Testing of Electric Vehicle Charge Point RCD's	47

10. Earth resistance measurement	49
10.1. Connection terminals	49
10.2. Touch voltage limit.....	49
10.3. Making a measurement – Two pole resistance measurement.....	49
10.4. Making a measurement – Three terminal resistance measurement	50
10.5. Making a measurement – Three terminal resistance measurement using ART	51
10.6. Two-clamp stake-less measurement (MFT1835 and MFT1845+ Only).....	52
11. Setup options	53
12. Warning messages	54
12.1. Startup warnings	54
12.2. Battery.....	54
12.3. Battery charger	54
12.4. Fuse warning	54
12.5. Invalid rotary switch setting	54
12.6. Continuity test	54
12.7. Insulation test	54
12.8. RCD test (or GFCI)	54
12.9. RCD range selection errors.....	55
12.10. Loop test	55
12.11. Earth test	55
12.12. Test will not start	55
13. Appendix A – Sending, Storing, Deleting and Recalling Test Results (MFT1835 and MFT1845+)	56
14. Appedix B – Downloading data via Bluetooth® (MFT1835 and MFT1845+)	60
15. Appendix C – Installation category definitions.....	61
16. Appendix D – Safe working practice	61
17. Appendix E – Cleaning and maintenance	61
18. Appendix F – Earth resistance testing – Basic principles	62
18.1. F.1 Principle of operation (three-terminal resistance measurement).....	62
18.2. F.2 Principle of operation (three-terminal resistance measurement using ART)	63
18.3. F.3 Principle of operation (two-clamp stake-less resistance measurement).....	63

19. Specifications	64
19.1. Accuracy	64
19.1.1. Insulation test	64
19.1.2. Continuity / Resistance	64
19.1.3. Loop test 2Hi (L-PE, L-N, L-L)	64
19.1.4. Loop test 3Lo, 2Lo (L-E).....	64
19.1.5. RCD test	65
19.1.6. Voltage	65
19.1.7. Frequency	65
19.1.8. Earth test ranges	65
19.1.9. Current (via Clamp meter).....	65
19.1.10. mV Sensor input	66
19.1.11. Internal memory.....	66
19.1.12. Power consumption	66
19.1.13. Temperature (via 3rd Party Module).....	66
19.2. Environmental Specification.....	66
20. Accessories	67
21. Repair and Warranty	68
21.1. Calibration, repair and spare parts.....	68
21.2. Approved Service Centres	68

1. Safety

1.1 Safety Warnings

Safety warnings and precautions must be read and understood before the instrument is used. They must be observed during use.

- The circuit under test must be switched off, de-energised and isolated before test connections are made when carrying out insulation and continuity tests.
- Continuity of protective conductors and earthed equipotential bonding of new or modified installations must be verified before carrying out an earth fault loop impedance test, RCD or earth testing
- Do not touch circuit connections and exposed metalwork of an installation or equipment under test. Under fault conditions the system earth could become hazardous live.
- Do not touch the earth stakes, test leads and their terminations (including connections to the earthing system under test) if an installation earth fault can arise, unless adequate precautions are taken.
- The 'live circuit warning' and 'automatic discharge' functions are additional safety features and should not be regarded as a substitute for normal safe working practices.
- Do not move the rotary switch positions while a test is in progress.
- Do not operate the instrument or connect it to any external system if it shows any visible signs of damage or if it has been stored for prolonged periods in unfavourable conditions.
- Do not operate the instrument or connect it to any external system if the battery compartment or casing is open or any parts of the case (including keypad, selector switch, display window, etc.) are missing.
- Always disconnect the instrument from all systems while batteries are being changed or the fuse replaced.
- Do not replace rechargeable cells in the instrument with non-rechargeable "dry" cells and attempt to charge the cells. This can cause explosion or fire.
- Do not operate charging equipment supplied with the instrument in damp or wet environments or outdoors. All test leads must be removed from the instrument while charging.
- After insulation tests, capacitive circuits must be allowed to discharge before disconnecting test leads. Locking the insulation test ON should only be used where there is no risk of a circuit holding a charge.
- The instrument should not be used if any part of it is damaged.
- Test leads, probes and crocodile clips must be in good order, clean and with no broken or cracked insulation.
- All test leads supplied with the instrument form part of the measuring circuit of the instrument. They must not be modified or changed in any way, or be used with any other electrical instrument or appliance.
- A plug severed from the power cord MUST be destroyed, as a plug with bare conductors is hazardous in a live socket outlet.
- Ensure that hands remain behind guards of probes/clips when testing.
- U.K. Safety Authorities recommend the use of fused test leads when measuring voltage on high energy systems.
- Replacement fuses must be of the correct type and rating.
- Failure to fit the correctly rated fuse will result in damage to the instrument in the event of an overload.
- Special precautions are necessary when operating in situations where "live" earths may be encountered: isolation switches and fuses (not supplied with this instrument) must be used.
- Special precautions are necessary when working near high tension systems (MV and HV): rubber gloves and shoes (not supplied with this instrument) should be worn.
- Special precautions are necessary when working in wet conditions or in agricultural areas: observe the local safety standards and take all necessary special precautions applicable to the particular location and do not touch the test leads with bare hands.

1.2 Live earth safety precautions

A 'Live' earth is one that carries current from the mains supply, or could do so under fault conditions. The following warnings apply in addition to those listed previously:

- All persons involved must be trained and competent in isolation and safety procedures for the system to be worked on. They must be clearly instructed not to touch the earth electrode, test stakes, test leads, or their terminations if any 'Live' earths may be encountered. It is recommended that they wear appropriate rubber gloves, rubber soled shoes, and stand on a rubber mat.
- The earth electrode under test should be isolated from the circuit it is protecting before testing commences. If this is not possible, ART (attached Rod Technique) may be used to measure electrode resistance.
- The instrument terminals should be connected to the system under test through isolation switches that are rated to handle the likely maximum fault voltages and currents that could be encountered at the installation. The isolation switch must be open whilst any personal contact is made with the remote test stakes, or the connecting leads, e.g. when changing their position.
- The instrument terminals should be connected to the system under test through fuses that are rated to handle the likely maximum fault voltages and currents that could be encountered at the installation.

NOTE









THE INSTRUMENT MUST ONLY BE USED BY SUITABLY TRAINED AND COMPETENT PERSONS

Users of this equipment and/or their employers are reminded that Health and Safety Legislation requires them to carry out valid risk assessments of all electrical work so as to identify potential sources of electrical danger and risk of electrical injury such as inadvertent short circuits. Where the assessments show that the risk is significant then the use of fused test leads constructed in accordance with the HSE guidance not GS38 'Electrical Test Equipment for use by Electricians' should be used .

This instrument is internally protected against electrical damage when used for the purposes of testing low voltage electrical installations as defined herein. If used in a manor other than those defined in this user guide, the protection capabilities could be impaired with potential risk to the operator and the instrument.

1.3 Symbols used on the instrument

This section details the various safety and hazard icons on the instruments outer case.

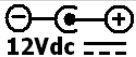
Icon	Description
	Caution: Refer to accompanying notes
	Maximum 300 V AC CAT IV to earth
	Maximum nominal system voltage of 600 V
	Instrument protected by 2 x F2 1000 V 30 kA fuses
	Equipment complies with current EU directives
	Equipment complies with current UK legislation
	Do not dispose of to landfill, sewage systems or by fire.
	Equipment complies with current 'C tick' requirements
	12 V DC charger socket

2. Introduction

Congratulations on your purchase of a genuine Megger Multifunction tester. The MFT1800 series Multi-function tester is a compact instrument designed to perform all of the functions required by the electrical contractor to fully test domestic, commercial and industrial wiring. Specially designed to comply with U.K., European and other International wiring regulations and standards, the MFT1800 may be used on all single and three phase systems with rated voltages up to 300 V AC. rms to earth (ground).

2.1 Overview

2.1.1. Front panel and controls

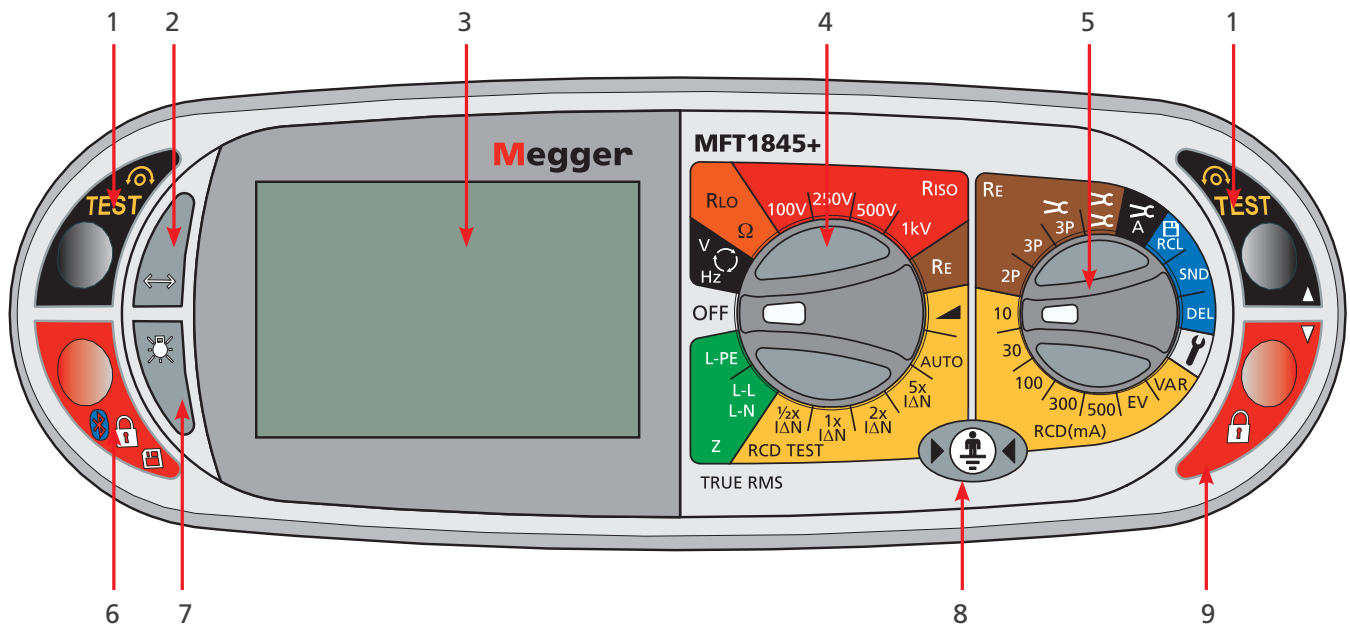

Item	Description	Item	Description
1	Test button Lead Null	6	Test lock Setup selector Results store
2	Mode	7	Display backlight
3	Display	8	Touch voltage contact point
4	Primary functions	9	Test lock Setup selector
5	Secondary functions		

Introduction

2.1.2. Display

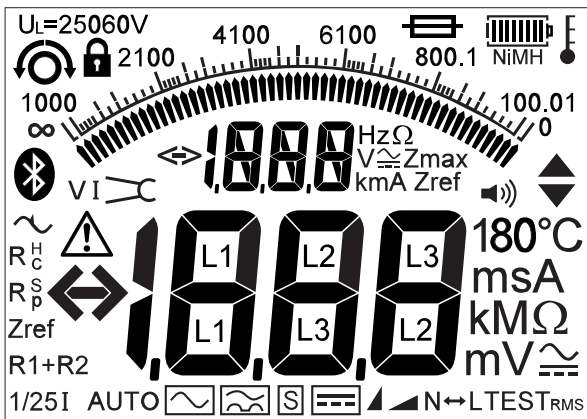

NOTE : Some features detailed within this user guide are model dependent.

Not all features appear on all models

2.1.3. Display symbols

Symbol	Description	Symbol	Description
	Test function locked on (also used to indicate a change is saved in setup)		Warning triangle – instruction to refer to this user guide
	Test lead null active		Fuse blown
U_L = 50V	Touch voltage limit (and Earth test voltage) set to 50 V (change setup)		Battery indicator
	Buzzer enabled	NiMH	Battery type set to rechargeable NiMH - Change in setup section 10
AUTO	RCD test in AUTO mode	>100 V	Indicates that the ground noise voltage exceeds the instrument measurement capability (test is inhibited)
	Type AC RCD selected	Rp (Rs)	Potential stake (P stake) resistance exceeds range for accurate measurement
	Type A RCD selected	Rc (RH)	Current stake (C Stake) resistance exceeds range for accurate measurement
S	Type S RCD (Type AC)	V ~	Ground noise voltage exceeds range for accurate measurement of resistance
S	Type S RCD (Type A)	V ~	MVC1010 error
	Type B RCD selected	I ~	MCC1010 error
	Fast or Full RAMP test selected		Bluetooth® enabled
TEST	Instrument is running a test		Instrument is too hot, allow to cool
	Earth loop noise detected.	N<->L	Live and neutral connections reversed
Zref	Reference loop measurement	R1+R2	Loop measurement with Zref value automatically deducted
ZMAX	Loop maximum measurement		

2.1.4. Waste electrical and electronic equipment

WEEE



The crossed out wheeled bin placed on Megger products is a reminder not to dispose of the product at the end of its life with general waste.

Megger is registered in the UK as a producer of electrical and electronic equipment. The Registration No is WEE/HE0146QT

2.1.5. Battery and fuse location, fitting and replacement

Battery type: 6 x 1.5 V Alkaline LR6 (AA) or NiMH HR6 rechargeable

Fuse type: 2 x F2 1000 V 30 kA fuses

Battery condition is shown by the following display symbols:

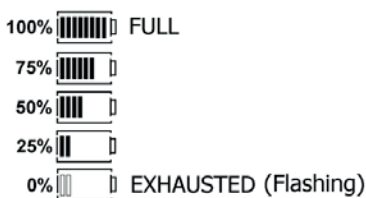

Where NiMH rechargeable batteries are fitted, the battery condition display can be adjusted accordingly. Refer to section 10 Setup options to change between alkaline and rechargeable batteries.

When set to NiMH batteries, the battery indicator in the display will show NiMH under the battery status symbol as below: (Feature available on all models).



To replace batteries or fuse:

Switch off the instrument.

Disconnect the instrument from any electrical circuits.

Remove the battery cover from the base.

For battery replacement:

Remove old cells and refit new batteries following correct polarity as marked on the battery holder.

Replace the battery cover.

Incorrect battery cell polarity can cause electrolyte leakage, resulting in damage to the instrument.

For fuse replacement

Withdraw each fuse in turn and check for failure. The blown fuse must be replaced with a F2 1000 V 30 kA fuse.

Rechargeable batteries and battery charging

Some models are supplied with rechargeable NiMH cells. These batteries can be charged in the instrument, using the supplied Megger charger.

To charge the batteries:

Ensure fitted batteries are of the rechargeable NiMH type.

Introduction

Connect the 12 V DC plug of the charger to the socket on the front of the MFT marked

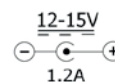

WARNING : Whenever battery cells are being recharged, there should be no connections to the instrument terminals and the instrument should be switched off.

WARNING : Do not attempt to recharge non-rechargeable (Primary) cells. Doing so may result in instrument damage and may cause personal injury.

Ensure ambient temperatures are between 4 °C and 40 °C while charging the MFT.

NOTE : The crossed out wheeled bin placed on the batteries is a reminder not to dispose of them with general waste at the end of their life.

Spent Alkaline and NiMH batteries are classified as portable batteries and should be disposed of in the UK in accordance with Local Authority requirements. For disposal of batteries in other parts of the EU contact your local distributor.

Megger is registered in the UK as a producer of batteries.

The Registration number is BPRN00142

3. Operation

3.1 General operation – all models

3.1.1. Switching on

Turn the rotary knob away from the off position.

The instrument will perform internal self tests then display the appropriate test screen, depending on the position of the function knobs.

3.1.2. Switching off

Turn the primary function knob to the OFF position.

The instrument will automatically turn itself off after 20 minutes* of inactivity. Press any button or turn either of the rotary knobs to turn back on.

* 2 minute option in Setup, refer to section 10.



3.1.3. Backlight

Press the backlight button.  The backlight will operate for 20 seconds.

3.1.4. Test buttons

Test buttons are duplicated on the left and right. Both buttons perform the same function except, when the  is displayed, in this case the right hand buttons perform a scrolling function. The left RED button also performs storage and lock functions on the MFT1731.

3.1.5. Test button lock

To lock the test button, hold down either of the RED test lock buttons with the  symbol, whilst holding down the test button. If  is displayed, the right hand buttons perform a scrolling function.

3.2 Mode button functions

The function of the mode button is dependent on the test function selected:

Test selected	Function	Options	Comments
V / mV °C	Volts (mv model specific)		Temperature requires suitable transducer
Continuity RLO	Buzzer ENABLE/DISABLE	Buzzer ON Buzzer OFF	Buzzes on $<2 \Omega$ May be changed in SETUP. Refer to "11. Setup options" on page 53.
Insulation RSIO	Buzzer ENABLE/DISABLE	Buzzer ON Buzzer OFF	Buzzes on $<1 M\Omega$ May be changed in SETUP. Refer to "11. Setup options" on page 53.
Loop impedance (Z) L-PE	3Lo - 3 wire no trip 2Hi – 2 wire high current 2Lo – 2 wire no trip	3Lo 2Hi 2Lo	3Lo default measurement 2Lo not available if 3 wire connection is detected
RCD/GFCI	0° /180° selection	0° 180°	(Press and release)
	RCD Type	AC A AC(s) A(s) B	(Press and HOLD) Type B available on MFT1835 and MFT1845+ only
EARTH (RE)	Touch voltage limit	50 V/ 25 V	(Press and release)
SETUP	Refer to "11. Setup options" on page 53.		

3.3 Test inhibit

Each test mode has conditions under which testing will be inhibited, as below:

3.3.1. Insulation

Detection of a circuit voltage above 50 V (a warning is displayed at 25 V)

3.3.2. Continuity

Detection of a circuit voltage above that used by the instrument will inhibit testing

3.3.3. Earth loop impedance

Touch voltage exceeds 50 V (or 25 V depending on instrument configuration)

Supply voltage over range or under range

Supply frequency out of specification

3.3.4. RCD/GFCI testing

Touch voltage detected or predicted to exceed 50 V (or 25 V depending on instrument configuration)

Supply voltage over range or under range

Supply Frequency out of specification

3.3.5. Earth testing

External voltage greater than 25 V present

Leads not connected as per the test requirements

Potential stake not within range (Rp)

Current stake not within range (Rc)

Other conditions that will inhibit testing include:

3.3.6. Battery exhausted

All testing will be inhibited in the event of a flat battery, refer to **"2.1.5. Battery and fuse location, fitting and replacement"** on page 13.

4. Voltage, frequency, current and temperature measurement

4.1 Making a voltage measurement

1. Set the Main rotary range knob to volts **V**
(The position of the right hand rotary range knob does not matter)

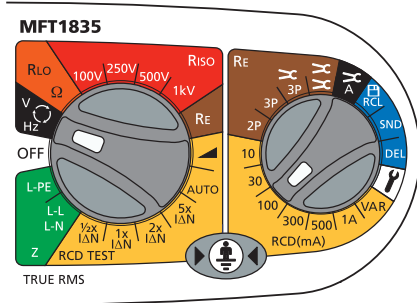

2. Using two test leads, connect test leads to the L1 (+ve) and L2 (-ve) terminals

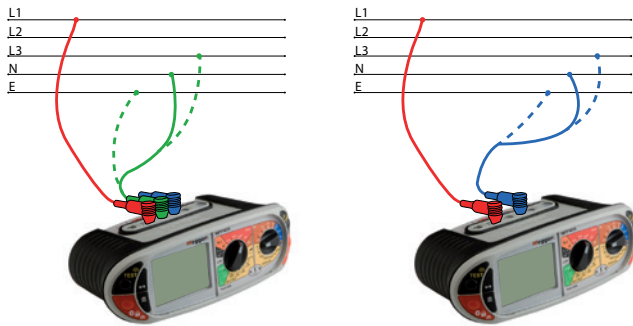

OR if Using the Mains plug Lead SAI10:

1. Connection (a)
For Live to Neutral measurements, connect the Red connector to the L1 terminal and the Blue connector to the L2 terminal
2. Connection (b)
For Live to Earth measurements connect the Red test to the L1 terminal and the Green connector to the L2 terminal

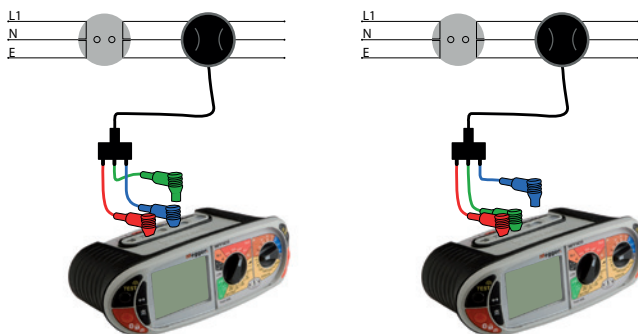

Connection (a)

Connection (b)

NOTE : When connecting all three test leads (eg Phase, Neutral and Earth) or the mains plug test lead, the voltage displayed is the highest of the three possible voltages.

Pressing either TEST button scrolls through L-E, N-E and L-N individual voltages. When the frequency of supply is shown, the voltage displayed reverts to the maximum voltage across all 3 terminals.

On models with a dedicated mV range this is selected using the Mode  button to select mV mode.

4.2 Frequency measurement

1. Automatically displayed when connecting to a live circuit as per 4.1

4.3 Phase rotation

Display of Phase rotation is Automatic when all three test leads are connected to the 3 phase supply as below:

1. Set the main rotary range knob to volts **V**
(The position of the right hand rotary range knob does not matter)
2. Using three test leads, connect test leads to the L1 to Phase1, L2 to Phase 2 and L3 to Phase 3. The MFT will display L1 L2 L3 or L1 L3 L2 depending on the direction of phase rotation.

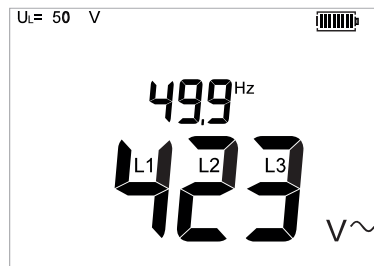
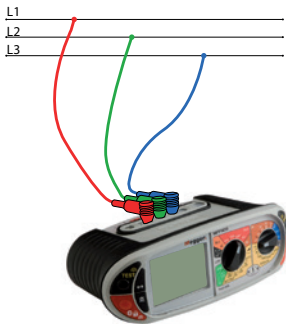

Normal rotation

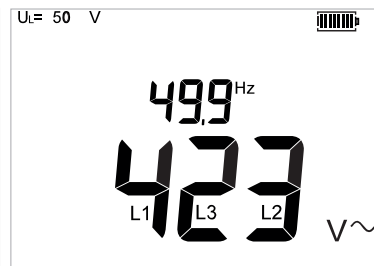

Reverse rotation

4.4 Leakage current measurement

Leakage current measurement uses the optional accessory current clamp (MCC1010).

1. On the MFT1825 and 1835 set the primary (left hand) knob to **RE** and the secondary (right hand) knob to 

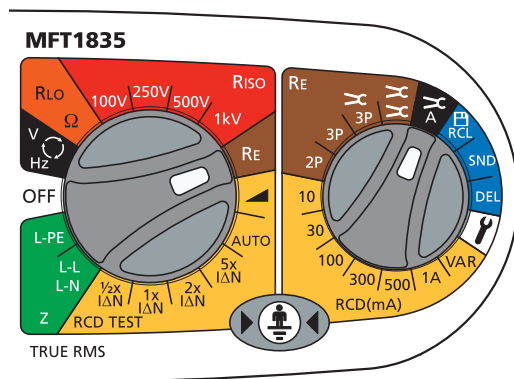

2. Connect to MCC1010 (part No. MCC1010) to the MCC1010 socket  on the MFT
3. Connect the clamp to the circuit conductor. The instrument will display the ac current flowing in the conductor.

4.5 Temperature measurement (not on MFT1815)

1. Connect the thermocouple transducer to the L1 (+ve) and L2 (-ve) terminals. The transducer should have a 1 mV DC output per °C.
2. Press the Mode  button to select °C. (Pressing the mode button will cycle round the V, mV and °C measurement modes). The display will show the temperature at the tip of the temperature probe.

4.6 Switch probe

In the V/mV/°C mode all measurements except temperature can be made with the remote switch probe. Tests are automatic and do not require the test button to be pressed.

1. Connect the switch probe to the switch probe socket. The probe replaces the standard RED test lead and can now be used as a normal test probe.

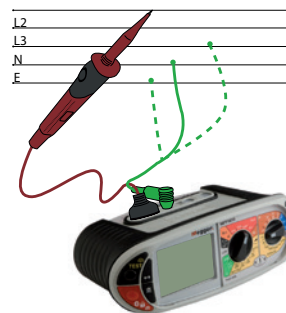

5. Continuity / resistance measurement

IMPORTANT

The continuity test will auto-range from 0.01 Ω to 99.9 k Ω . Circuits up to 2 Ω will be tested at >200 mA. To change the test current, go to **"11. Setup options"** on page 53.

The continuity test is automatic. The test starts as soon as the leads are connected to a circuit. The TEST button is ONLY used to null the lead set.

WARNING : Prior to any continuity testing, ensure the circuits under test are isolated and not live.

SETUP allows the follow configuration options:

- Positive test current
- Bi-Directional test current

Bi-directional test current allows the automatic testing of the circuit in both directions and the highest measured value being displayed See **"11. Setup options"** on page 53.

5.1 Nulling test lead resistance (up to 9.99 ohms) Ω

Before starting a continuity test, the test lead resistance should be nulled such that it does not add extra resistance to the circuit being measured. Once nulled it does **not need** repeating for each test. Periodically it should be checked to ensure nothing has changed.

The "Lead Null" value is retained even when the tester is switched off.

To null test leads:

1. Short test probes or clips together and press the TEST button. The null symbol  will be displayed to indicate lead null is active.

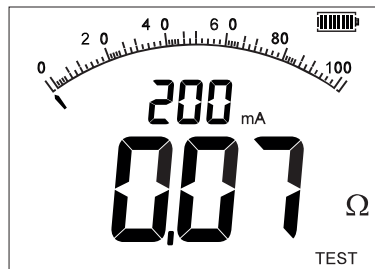
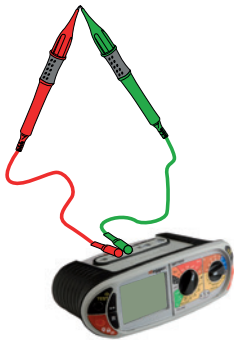

Lead null OFF



Lead null ON

This null value is stored until the TEST button is pressed again.

2. To cancel the LEAD NULL, separate the test leads and press the TEST button.

5.2 Making a CONTINUITY measurement

1. Set the Primary (Left) range knob to Ω range. (The position of the right hand rotary range knob must not be in the Ω position).

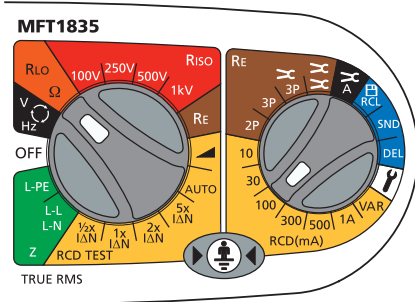

2. Connect two test leads to the L1 (+ve) and L2 (-ve) terminals on the instrument. A continuity measurement is made automatically.

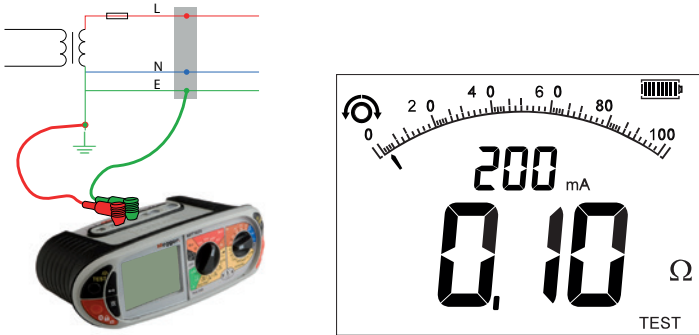

NOTE : Measurements are prevented when:

- A resistance of > 99.9 k Ω is present
- Circuit voltages in excess of 4 V are detected.

5.3 Storing / downloading results (Not MFT1815 or MFT1825)

For full details see “13. Appendix A – Sending, Storing, Deleting and Recalling Test Results (MFT1835 and MFT1845+)” on page 56

Once the display shows a value it will automatically be logged into temporary memory. Unless stored, this will be over written by the next measurement.

To store this result or to send it to Certification Software (such as **CertSuite.app**), refer to “13. Appendix A – Sending, Storing, Deleting and Recalling Test Results (MFT1835 and MFT1845+)” on page 56.

5.4 Continuity Buzzer ON/OFF

Whilst in the continuity range, press the MODE button . This will toggle the buzzer ON and OFF.

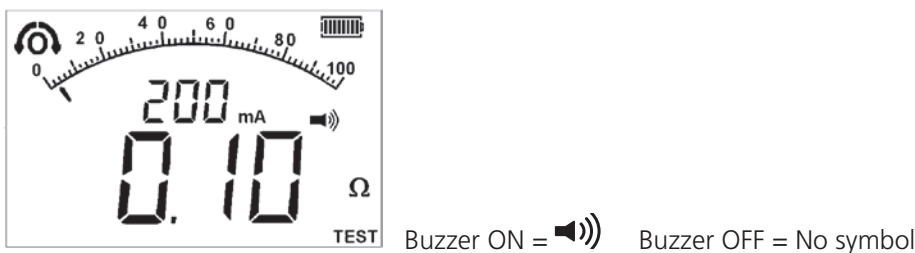

5.5 Switch probe (SP5)

In the CONTINUITY/RESISTANCE mode all measurements can be made with the remote switch probe (SP5). Tests are automatic and do not require the TEST button to be pressed.

1. Connect the switch probe to the switch probe socket L1 (+ve). The switch probe replaces the standard RED test lead. Test as in **"5.2 Making a CONTINUITY measurement" on page 22.**

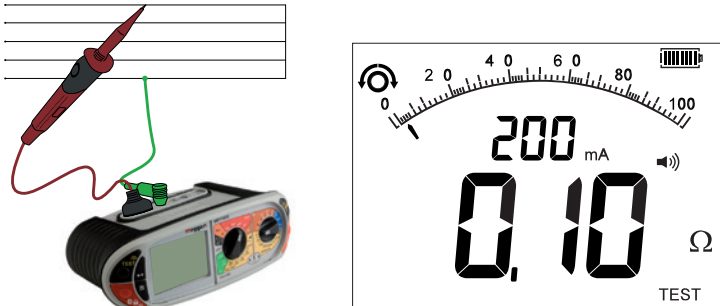

5.6 Buzzer threshold

If the measured resistance is less than the buzzer threshold, the buzzer will sound. The resistance at which the buzzer stops sounding can be changed to meet individual test requirements. See **"11. Setup options" on page 53.**

Selectable limits of 0.5 Ω, 1 Ω, 2 Ω, 5 Ω, 10 Ω, 20 Ω, 50 Ω, 100 Ω, (depending on model) are available.

This setting is stored even when the instrument is switched off.

5.7 Measurement methods and sources of error

Method of measurement

The 2-wire lead set must be used for this measurement. A DC voltage of nominally 4.4 V with a current limit of >200 mA is used to measure resistance less than 2 Ω.

Possible sources of error

Measurement results can be affected by the following:

- The presence of circuits connected in parallel.
- Presence of AC voltages on the circuit being measured
- A poor connection to the circuit under test
- Incorrectly nulled test leads
- Use of fused leads

6. Insulation resistance 500 V

NOTE : IMPORTANT

The insulation test is protected by a live circuit warning. Detection of a voltage over 50 V will inhibit testing. This applies whether or not the insulation test is locked on.

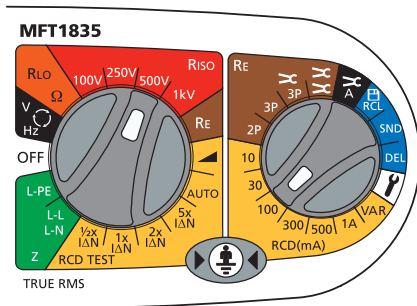

6.1 Making an INSULATION measurement

1. Set the left hand rotary range knob to the 500 V insulation test voltage required:

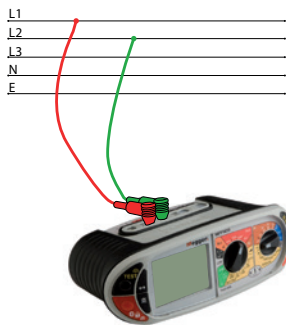

2. Connect two test leads to the L1 (+ve) and L2 (-ve) terminals on the instrument.



3. To start test, press and hold either of the TEST buttons,  or , on the instrument.
Release the test button after the displayed reading has settled. The circuit will now discharge safely.

NOTE : A 1000 V warning is displayed whenever the 1000 V range is selected for the first time and the TEST button is pressed.

6.2 Insulation test lock

To lock an insulation test ON, hold down either of the TEST buttons followed by either of the RED LOCK buttons.

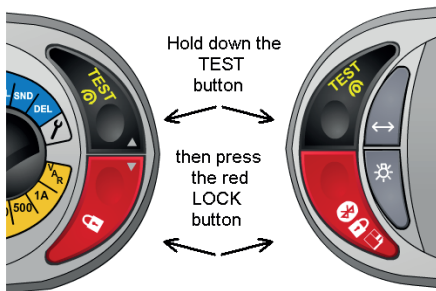

To release the "Locked on" insulation test, press the TEST button.

WARNING : The test voltage will be permanently present on the test probes or crocodile clips when in the locked position.

WARNING : Auto discharge - Auto discharge facility automatically and safely discharges the circuit at the completion of an insulation test.

Live circuit warning – operates when connected to Live circuits > 25 V. Testing is still permitted.

Test inhibited – Live circuits greater than 50 V will inhibit testing.

6.3 Measurement methods and sources of error

Method of measurement

The selected DC test voltage (current limited to less than 2 mA DC) is applied to the circuit under test and the resistance is calculated from measurements of the resulting voltage and current.

Capacitive circuits can take some time to charge. This is displayed as an increasing voltage that takes longer to reach its maximum than normal.

The reading is stable with a circuit capacitance less than 5 μF .

7. Loop impedance testing

NOTE : IMPORTANT

This measurement requires both selector knobs to be set to the Loop testing mode (GREEN RANGES).

This is a live circuit test. All precautions relevant to working on live circuits, to ensure the safety of the operator and any other personnel should be in place.

Overview of the LOOP IMPEDANCE test

A Loop impedance test is the measurement of the impedance of a circuit whilst the circuit is electrically live.

Unlike a continuity test, a loop impedance test applies a load to the circuit and measures the change in the circuit voltage, from which the loop “resistance” is calculated.

For those circuits protected by an RCD the load that is connected Phase to Earth must be small enough not to trip the RCD.

Consequently there must be many tests performed to establish the loop impedance of the circuit. These are automatically performed and the end result is displayed.

Test Lead Null:

The MFT does not need the resistance of the test leads to be nulled for this test. They are already calibrated into the measurement circuit at 0.07 Ω .

However if using fused leads or 3rd party test leads, the resistance of these leads may be different. In this case they can be measured using the continuity test and the resistance can be compensated for in the Setup options, see “**11. Setup options**” on page 53.

Circuit connection:

The MFT is designed to test the L-PE and the L-N (and L-L) part of the circuit. Selecting the L-PE range on the MFT will enable testing of the Live to Earth circuit as below:

7.1 Range selection and test leads

7.1.1. Phase to earth L-E circuits:

The main range knob and test leads should be connected as shown:

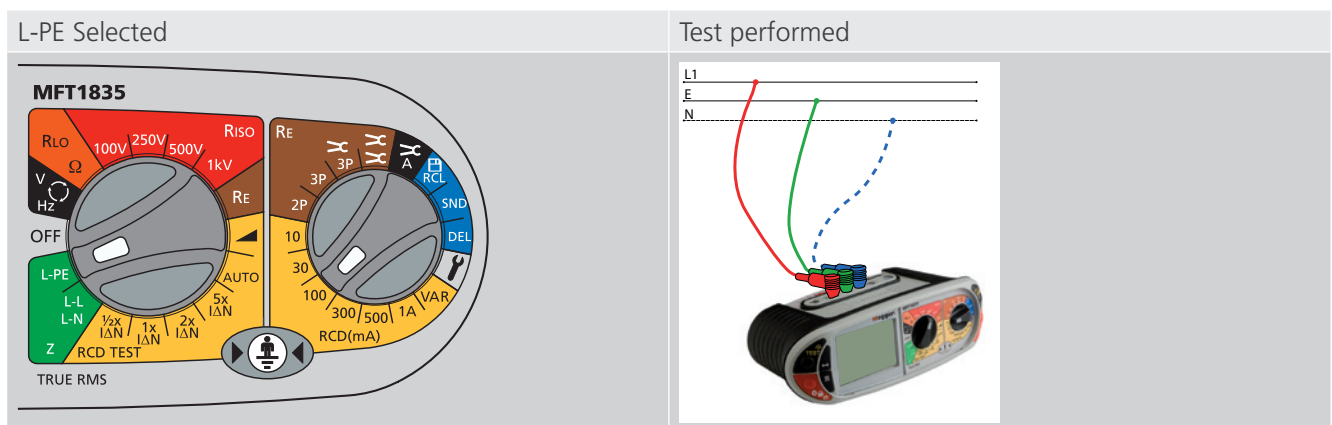

The right hand knob should be set to “Z”

Connecting the 3rd (Blue) lead enables the “3 wire loop test 3Lo, as above and “reverse polarity detection”.

Test Options in L-PE mode:

In L-PE mode the MFT1800 series offer 3 types of loop test:

3Lo – A 3-wire low current loop impedance test. This test requires all three connections.

Where to use:

For making L-E measurements on circuits where all three conductors are available AND the Phase – Earth circuit is RCD protected. **Requires all three test leads to be connected.**

2Hi – A 2-wire high current test. A fast 3-4 second test using high test currents.

Where to use:

On ALL circuits except Phase – Earth measurements on RCD protected circuits.

2Lo – A 2-Wire low current loop test for L-E measurements where the 3rd conductor is not available.

Where to use:

On RCD protected circuits where access to all three conductors is not possible

NOTE : 2Lo is not available when all three leads are connected, as the 3Lo is the preferred measurement mode.

Selecting the test mode:

To switch between Loop test modes press the Function button, as below:

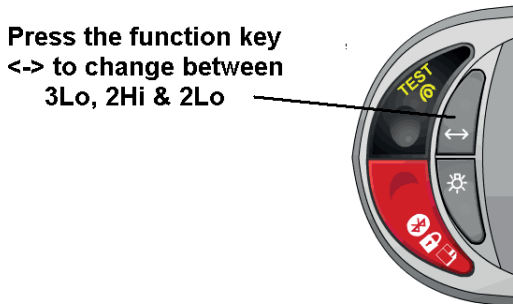

The test mode is displayed as below:

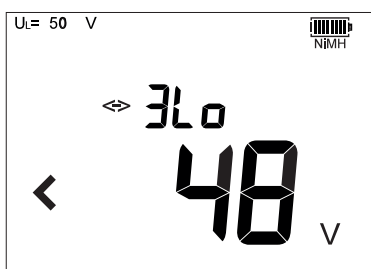

Default mode

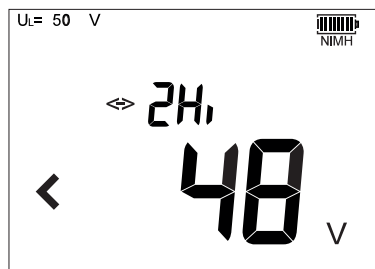

1st Press

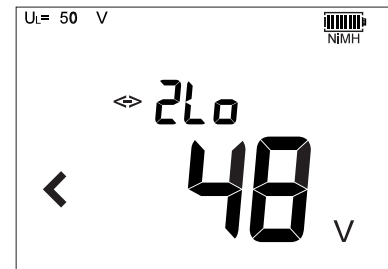

2nd Press

NOTE : RCDs can still trip when performing a “non-trip” loop test if there is an existing high level of fault current flowing in the Earth conductor, or the RCD is not operating within specification

Loop impedance testing

7.1.2. L-N or L-L circuits

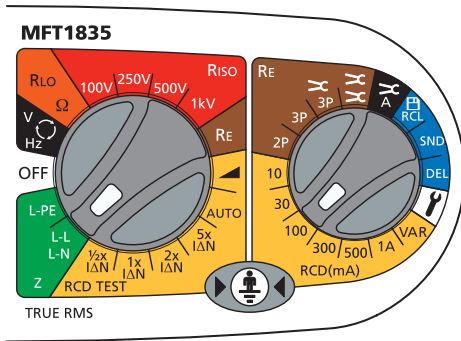

L-N (or L-L) selected

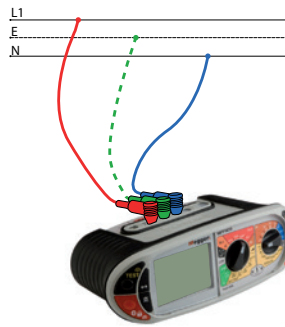

Test performed

Test options in L-N (L-L) mode

In L-N (L-L) mode the MFT1800 series offers one type of loop test:

2Hi – A 2-wire high current test. A fast 3-4 second test using high test currents.

Where to use:

On ALL circuits except Phase – Earth measurements on RCD protected circuits.

7.1.3. Z, Zmax, Zref and R1+R2 (MFT1721)

The right range knob has additional options.

- Z - Standard loop impedance measurements
- Zmax - For multiple loop measurements where the worst case value is required
- Zref - the Ze or Zdb value used when calculating the R1+R2 value
- R1+R2 - The loop impedance less the Zref value.

For general loop impedance testing the Z setting should be selected.

Refer to section 7.5 to 7.7 for additional functionality.

7.2 Making a loop impedance measurement

7.2.1. Ze measurements at the origin (Phase to Earth)

1. Set the LEFT rotary range knob to the **L-PE** range.

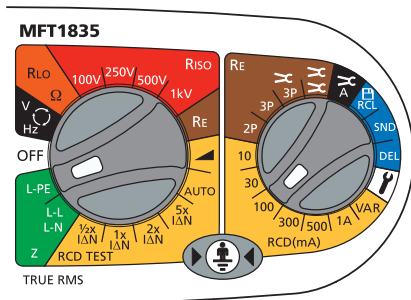

- Press the Function key <-> to select the "2Hi" mode. The RCD will not trip, so there is no need to use the 3Lo and 2Lo modes.

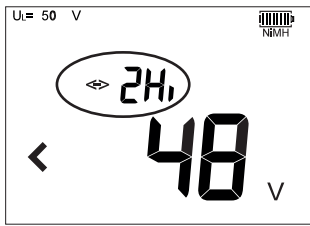

- Connect test leads as below, with the Red test lead connected to the L1 (Red terminal on the MFT and the Green test lead connected to the Green (L2) terminal.

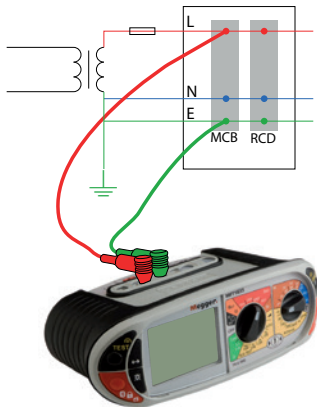



- Press TEST to start the test sequence. This can be automated in SETUP so the test starts when contacting the circuit. See "11. Setup options" on page 53.
- On completion of the test, the display will show the loop resistance on the large display segments, and the fault current on the small display segments.

Reverse Polarity warning:

The 3rd test lead can be connected to Neutral (L3) but is not used in the '2Hi' Phase-Earth measurement.

With the 3rd lead connected the MFT will show a Phase-Neutral reversed connection if present.

A warning symbol  played if there are any disturbances to the circuit under test during the test sequence. The display will show the  symbol. The loop impedance reading may have been compromised by the circuit interference. Repeat the test.

7.2.2. Zs and Zdb loop measurements without RCD - eg Zs, Zdb etc.

<p>1. Set the LEFT rotary range knob to the L-PE range</p>	<p>2. Press the Function key <-> to select the "2Hi" mode</p>

Loop impedance testing

3. Connect test leads as below, with the Red test lead connected to the Red (L1) terminal on the MFT and the Green test lead connected to the Green (L2) terminal.

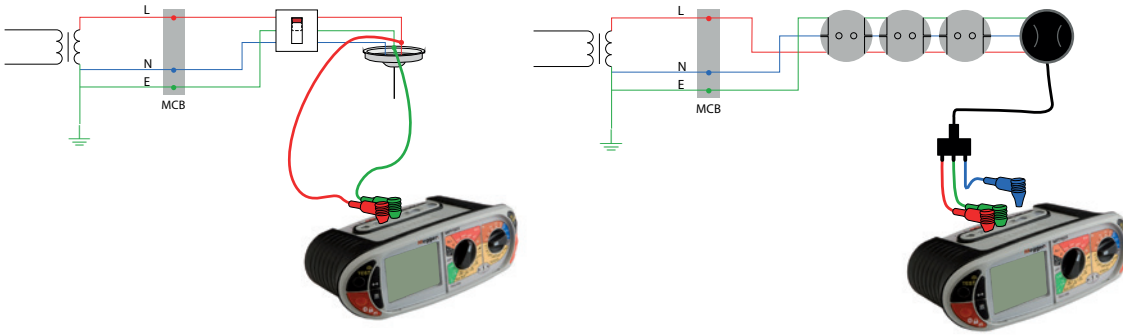

The Blue (L3) test lead can be connected to enable “reverse polarity” warnings

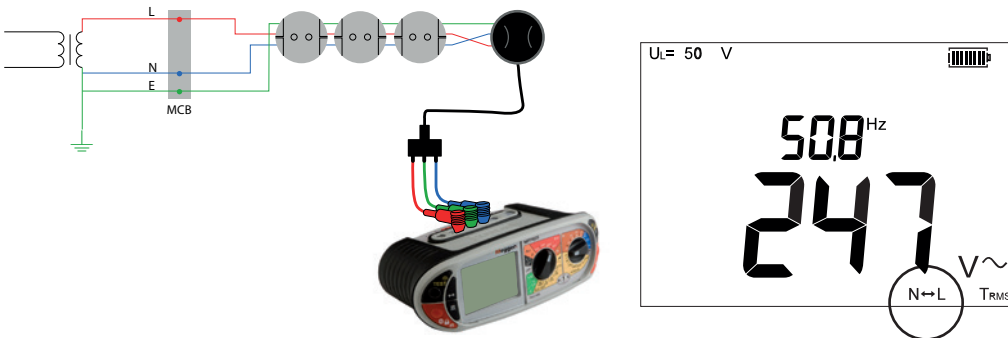

4. Press the Function key to select the “2Hi” mode.

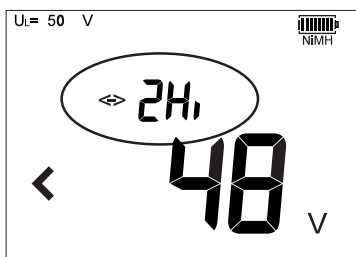

5. Press ‘TEST’ to start the test sequence. This can be automated in SETUP so the test starts when contacting the circuit. See **“11. Setup options” on page 53**.
6. On completion of the test, the display will show the loop resistance on the large display segments, and the fault current on the small display segments.

7.2.3. Earth Loop measurements with an RCD in circuit

Loop testing L-N through and RCD will not trip it, using the 2Hi test mode. However testing Phase to Earth requires a test that draws less current to help prevent the RCD tripping. It is impossible to guarantee that an RCD will not trip. If there is a risk associated with tripping an RCD alternative methods should be used for testing the circuit.

Using 3 wire measurement - 3Lo

1. Set the LEFT rotary range knob to the L-PE range.

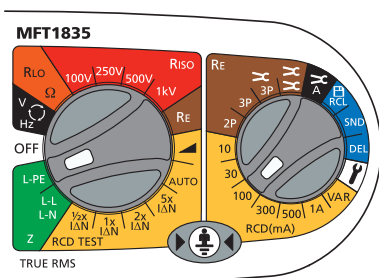

Loop impedance testing

- Press the Function key  to select the "2Lo" mode.

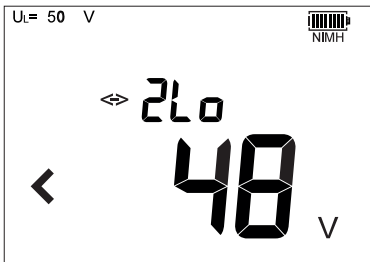

- Press TEST to start the test sequence.
- On completion of the test, the display will show the loop resistance on the large display segments, and the fault current on the small display segments.

7.3 Phase to Neutral (all models) or Phase to Phase testing

NOTE : Only the "2Hi" mode is available on this range.

- Set the LEFT rotary range knob to the  range.

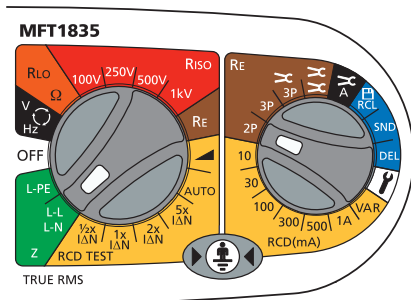

- Connect the test leads to the circuit as below, with the Red test lead connected to the Red (L1) Red terminal on the MFT and the Blue test lead to the Blue (L3) terminal.

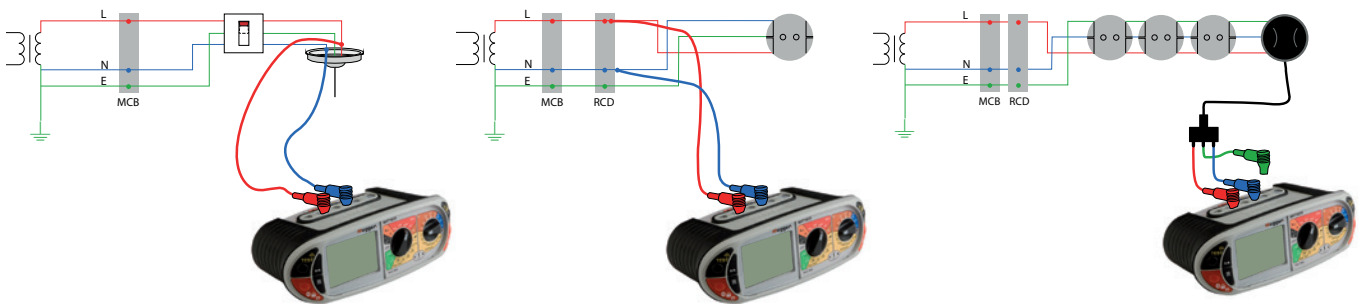

- Press and release the TEST button to start the test.
- On completion of the test, the display will show the loop resistance on the large display segments, and the fault current on the small display segments.

7.4 Prospective Fault Current and Short Circuit calculation (PFC & PSCC)

The prospective fault current and short circuit current of a circuit is automatically calculated when making a loop impedance test. The calculation uses a nominal circuit voltage, not the actual circuit voltage, and is displayed above the loop impedance measurement, as below:

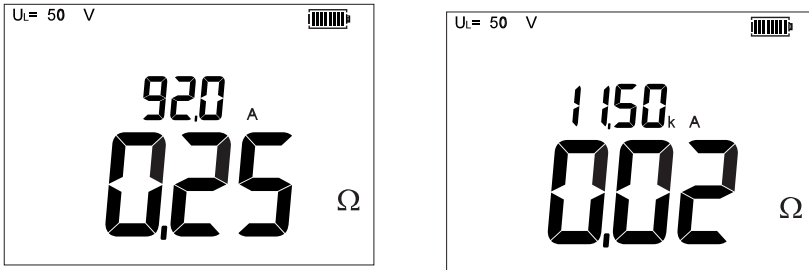

The fault current is calculated using the expression:-

$$\text{PSCC or PFC} = \frac{\text{Nominal supply voltage in Volts}}{\text{Loop resistance in Ohms}}$$

Example :PSCC or PFC = 230 V / 0.13 Ω
 = 1769 VA (displayed on the MFT as 1.77 kA)

The nominal supply voltage used in the calculation is automatically selected depending on the actual circuit voltage. The instrument uses the following voltage values:-

Actual measured voltage	Nominal voltage
< 75 V	55 V
≥ 75 V and <150 V	110 V
≥ 150 V and <300 V	230 V
≥ 300 V	400 V

Z_{max} test mode

Ideal for multiple loop measurements on a ring final circuit where the highest loop value is to be recorded.

Both **L-PE** and **L-N / L-L** test options can be used.

The current loop test value is displayed on the lower (larger) readout, whilst the maximum measured value of the sequence is displayed on the upper (smaller) readout.

7.5 Confidence Meter™ for non-trip (3Lo) loop impedance tests.

7.5.1. Display information

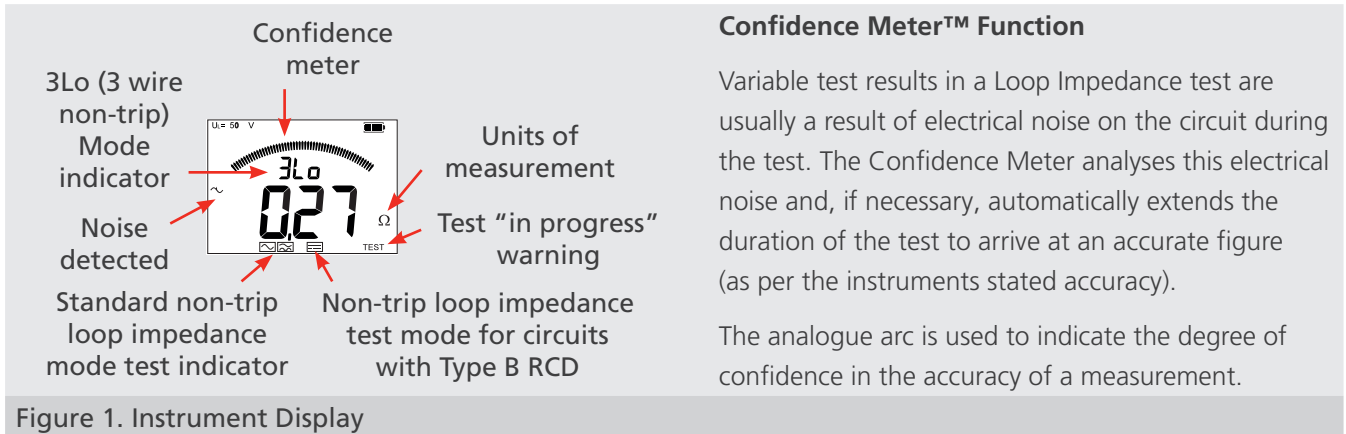

Figure 1. Instrument Display

During a test the analogue arc will reduce as the degree of confidence in the measurement increases. As the influence of electrical noise on the measurement is removed the analogue arc reduces down to one element. At this point the test stops and a final result is shown.

The arc may fluctuate during a test and the shown digital value will change as the Confidence Meter analyses the electrical noise and corrects the value.

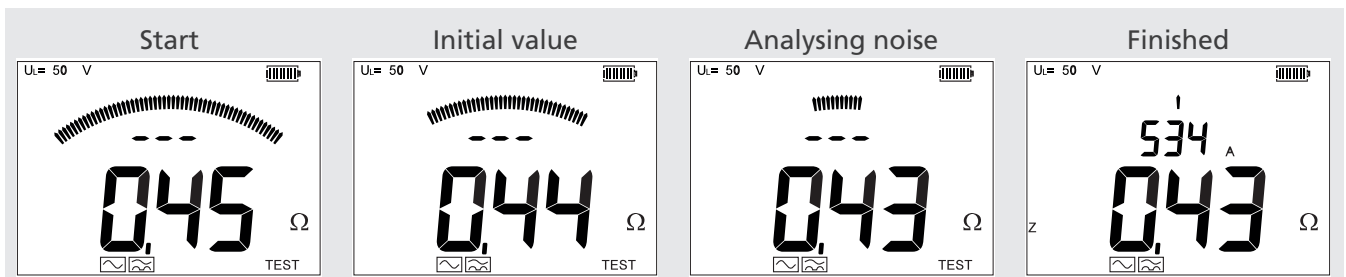

Figure 2. Analogue Arc

7.5.2. 3Lo Loop Impedance Measurement

Note: Test leads should not be disconnected during a test, as the sudden interruption of the test current could be detected by an RCD as a leakage fault and cause a trip. If this is considered to be potentially inconvenient or hazardous, change 3Lo from AC/A to B mode. This will reduce the risk of the RCD tripping.

Important: It is impossible to guarantee that an RCD will not trip as the RCD may be out of specification, subject to additional external influences, incorrectly connected or faulty. In this instance alternative methods to test the circuit characteristics are recommended, for example, the R2 method.

1. Select L-PE.
2. Connect the Live, Neutral and Earth test leads of the MFT to a live circuit. The display will show the standard warning screen.

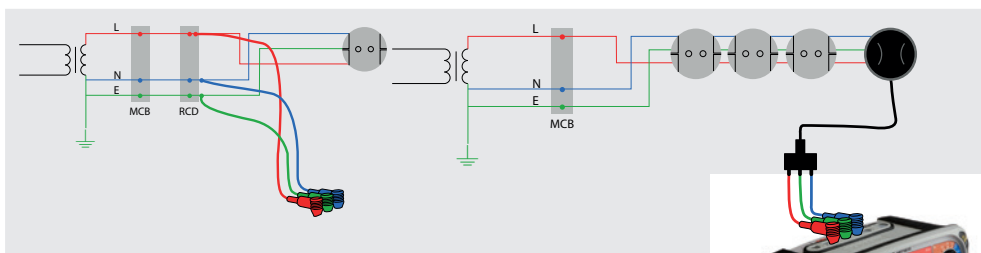

Figure 3. 3Lo Connection Options

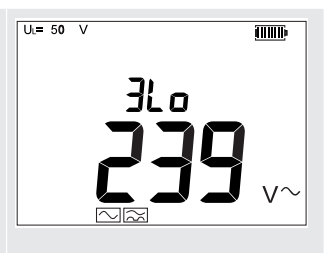
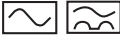

Figure 4. Live Circuit Warning Screen

The display will show , which indicates the suitability for use on circuits protected by a Type AC or a Type A RCD, or RCBO.

If the RCD on the circuit is a Type B, press and hold  until the display shows  (Type B RCD).

NOTE : If unsure of the RCD type use Type B setting.

3. Press TEST. The display will show the start of a Loop Impedance confidence test, followed by an initial value of loop impedance:

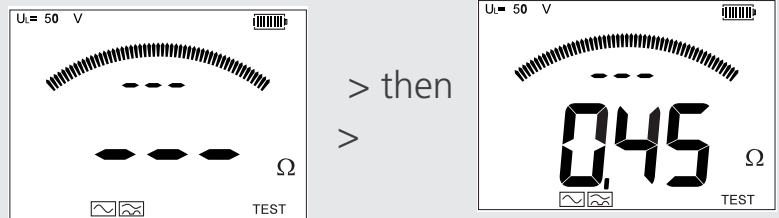

Figure 5. Loop Impedance Test Start Screen

NOTE : The test is not finished until the analogue arc reduces to one element, or the TEST button has been pressed again.

4. If no noise is detected the analogue arc will reduce to a single element and the display will show a completed test result. The final value may vary slightly if very small levels of noise were detected.

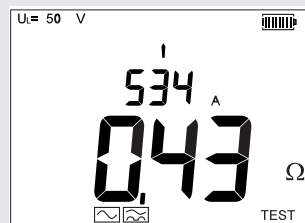

Figure 6. Final Result

5. If electrical noise is detected, the instrument analyses it continuously and the analogue arc will reduce as the electrical noise is filtered from the measurement. Even if there is a lot of electrical noise, the confidence of the measurement will improve with time and the analogue arc will reduce, so that a final stable value will show at the end.

 (electrical noise symbol) will also show to indicate the presence on electrical noise on the circuit.

If the electrical noise in the circuit varies the analogue arc may fluctuate until the test has completed and the analogue arc shows a single element.

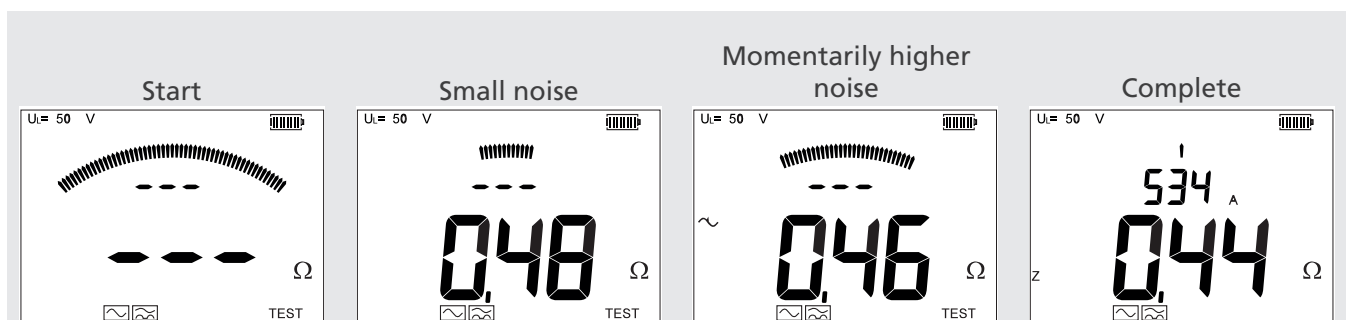

Figure 7. Analogue Arc Fluctuation

NOTE : The maximum measurement time is three minutes. If after three minutes there is still more than one element in the analogue arc, the test will stop. More than one element shows that the instrument has not achieved its desired confidence level (electrical noise is high). The test is still valid, but with reduced accuracy.

Press TEST at any time to stop the test. A digital test result will show and the size of the analogue arc shows the degree of confidence in the test result (smaller the analogue arc = more confidence).

7.6 Measurement methods and sources of error

Method of measurement

During a loop test the instrument measures the difference between the unloaded and loaded supply voltages. From this difference it is possible to calculate the loop resistance. The test current will vary from 15 mA to 5 A, depending on supply voltage and the loop resistance value. The volt drop from a 15 mA load is exceptionally small, consequently the instrument performs many measurements automatically. This test takes a long time to complete, typically 20 seconds

Possible sources of error

The reading depends on the stability of the supply voltage during the test. Therefore noise, harmonics or transients, caused by other equipment during the test could cause an error in the reading. The instrument will detect some sources of noise and warn the user.

It is recommended that more than one test is performed on the circuit to ensure the measured value is repeatable, especially when performing a 3Lo measurement.

Capacitive loads across the Phase-Earth circuit can affect the accuracy of the Non-trip loop test. For this reason the P-E (non-trip) loop test should not be used on the P-N circuits.

Errors can be reduced by:-

- Use the two-wire lead set with prods and making a firm connection to clean conductors.
- Make several tests and take the average.
- Ensure that potential sources of noise in the installation are isolated (switched off), eg: automatically switched loads or motor controllers

8. Residual Current Device (RCD) or Ground Fault Current Interrupt (GFCI) testing

NOTE : The MFT1800 series can perform the following RCD tests:

1/2I	Non-tripping test at half the rated RCD trip current for 2 seconds, during which the RCD should not trip
I	Tripping test at the rated RCD trip current. The trip time will be displayed
2xI	Tripping test at 2 x the rated RCD trip current (Only available on MFT 1825 and 1835 instruments)
5I	Tripping test at 5 x the rated RCD trip current. The trip time will be displayed in milliseconds.
0 or 180°	Some RCDs are sensitive to the polarity of the supply, i.e whether the test current is applied with the instantaneous rising or falling. Tests should therefore be performed with the polarity 0° and 180° and the maximum time recorded.
RampTest	Used to check the trip current of an RCD.
Fast Ramp test	This comprises a shorter test using fewer current steps compared to the standard ramp test. Allows significantly more tests in a given time.





The MFT1800 series can test the following RCD types:

Model	Type AC	Type A	Type S	Type B	EV RCDs	3 phase RCD	Programmable RCDs
MFT1825	✓	✓	✓	✓			✓
MFT1835	✓	✓	✓	✓			✓
MFT1845+	✓	✓	✓	✓	✓	✓	✓

A Programmable RCD is typically a type A RCD with variable disconnection time. RCD's are also available with a Selective (Delayed) trip time. These are referred to as Type S. These RCDs do not trip instantly, allowing ordinary type RCDs to trip first.

Residual Current Device (RCD) or Ground Fault Current Interrupt (GFCI) testing

The characteristics of each RCD type is detailed below:

RCD Type	AC	A	S	B
Description	Operate with AC residual earth currents only.	Operate with AC and pulsed DC residual earth currents.	Selective RCD Operates on type AC with time delay or type A with time delay	Operate with AC
Symbol used			 also 	
Application	General purpose protection of Sinusoidal AC supplies.	Protects against AC and pulsed DC (rectified AC).	For use upstream of a standard AC RCD to prevent trip contention. ie. Allows local trip to operate first. TIP: Remember "S" for "Slow tripping"	Special applications where protection of DC, as well as AC earth faults may be encountered. Other types will not operate on DC fault currents.
Trip times	Trip times as defined in BS EN			
$\frac{1}{2} I$	>300 ms (>1999 ms UK) No trip	>300 ms (>1999 ms UK) No trip	300 ms (>1999 ms UK) No trip	>300 ms (>1999 ms UK) No trip
1 x I	≤ 300 ms	≤ 300 ms	130 ms to 500 ms	≤ 300 ms
2 x I	≤ 150 ms	≤ 150 ms	60ms to 200ms	
5 x I	≤ 40 ms (30 mA RCD's only)	≤ 40 ms (30 mA RCD's only)	≤ 40 ms <150 ms (30 mA RCD's only)	≤ 40 ms <150 ms (30 mA RCD's only)

8.1 Making an RCD measurement

NOTE :

- To select 0° or 180° press and release the mode button  whilst in RCD test mode
(Note: Type B is not available on MFT1815 instruments)
- 10 mA and 30 mA RCD's should be tested at $\frac{1}{2} x I$, 1 x I and 5 x I
- All other RCDs only need to be tested at 1 x I
- I = trip current rating of the RCD
- 2 x I available on the MFT1825 and 1835 only.
- Connecting the neutral test lead in either of the above options will not affect the RCD but will detect a reverse polarity and, the testing will be inhibited.

8.2 Selecting RCD type

Using the right hand (secondary range knob) select the RCD trip rating.
This is printed on the RCD (10 mA, 30 mA 100 mA etc.)



Select the RCD type, either AC, A, S or B by pressing and HOLDING DOWN the mode button  for 2 seconds whilst in RCD test mode. Repeat until the RCD type is displayed. Refer to table above for symbol options and descriptions.

NOTE : Type B RCD testing is NOT available on MFT1815.

8.3 1/2 x I RCD current rating (No-trip test)

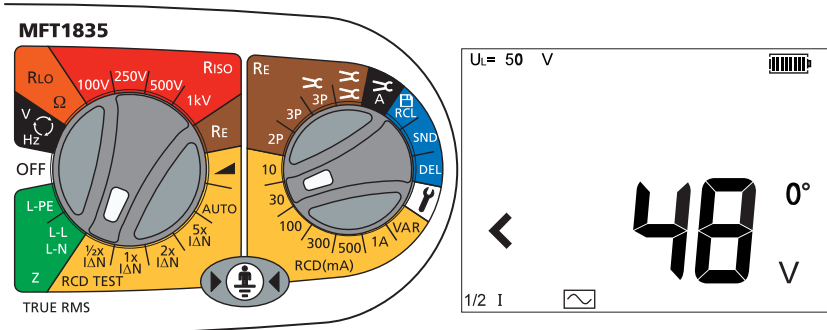
1. Set the LEFT rotary range knob to the **1/2 I** RCD test range.
2. Set the RIGHT rotary range knob to current rating of the RCD under test **30** = 30 mA etc. Ensure the display shows 0° in the display (see below):

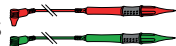

3. Connect the instrument Phase (L1) and Earth (L2) terminals to the RCD phase and Earth terminals (or to the phase and earth of the circuit the RCD is protecting). Use either the separate leads  or mains plug  leads.

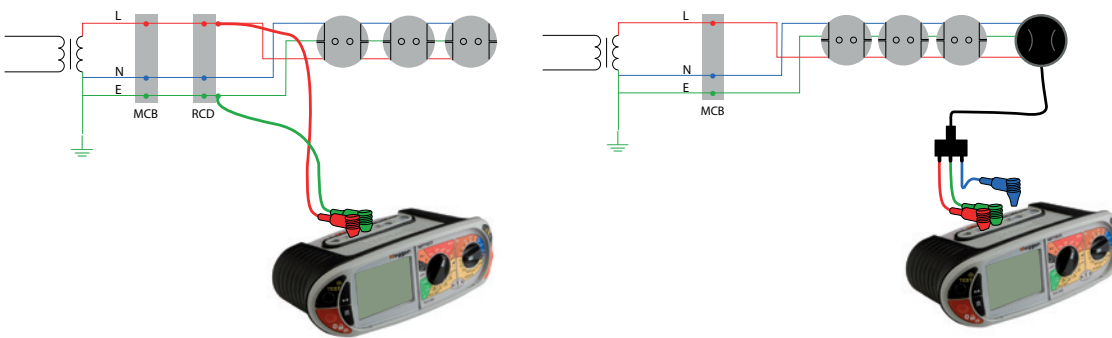

4. Press the TEST button. The Display should show one of the following:

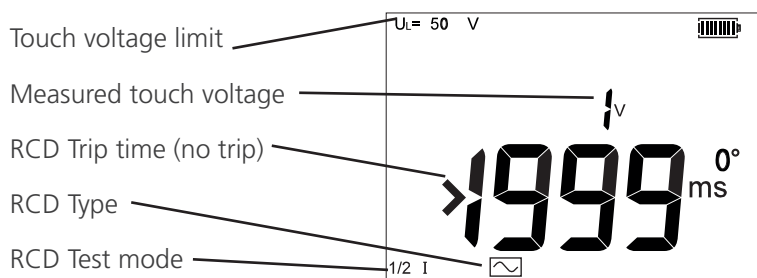

If the RCD Trips, the MFT will flash the "trP" warning and then display the following:

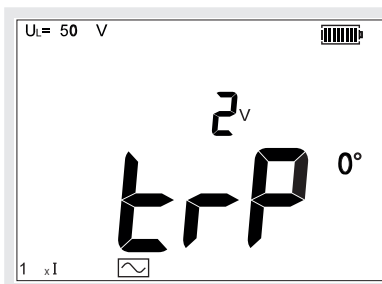

5. Press the  mode button to select 180°.
 6. Repeat the above test.
- Neither test should trip the RCD.
- | | | | |
|-------|----|---|----------------------|
| ??? | ms | = | RCD FAILED (no trip) |
| >1999 | ms | = | RCD Passed |

NOTE : For Type AC RCDs there is no need to perform a 180° test on the 1/2I mode, as the test uses a full AC waveform.

8.4 1 x I RCD current rating (Tripping test on 30 mA RCD)

1. Set the LEFT rotary range knob to the **I** RCD test range.

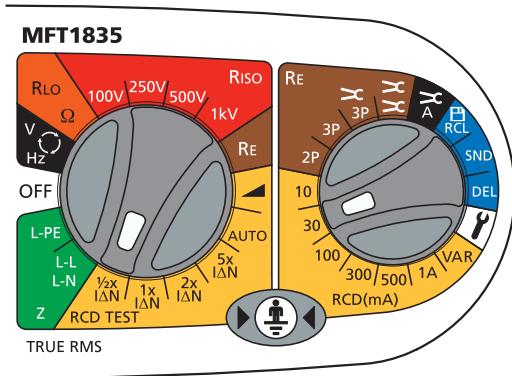

2. Connect the instrument as in 8.3. See **8.3 on page 39**
3. Press the mode button to select 0°.
4. Press the TEST button.

The Display should show one of the following:

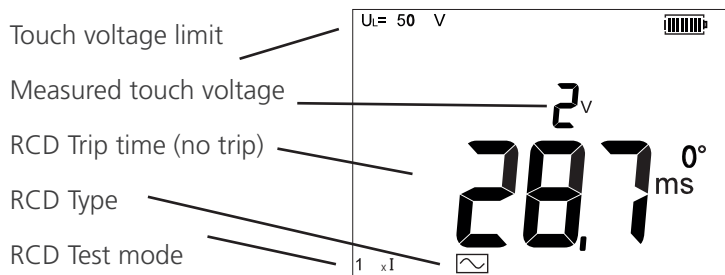

*any value below 300 ms indicates an RCD has tripped in an adequate time.

5. Press the mode button to select 180°
6. Repeat the above test.

Record the higher of the two values.

- >300 ms = RCD FAILED (no trip)
- <300 ms = RCD Passed

8.5 2 x I RCD Current Rating (Tripping test on 30mA RCD) – MFT1825 & 1835 ONLY

1. Repeat the test sequence in 8.4 but with the LEFT rotary range knob to the **2I** RCD test range.
2. Press the \leftrightarrow mode button to select 0°.
3. Press the TEST button.

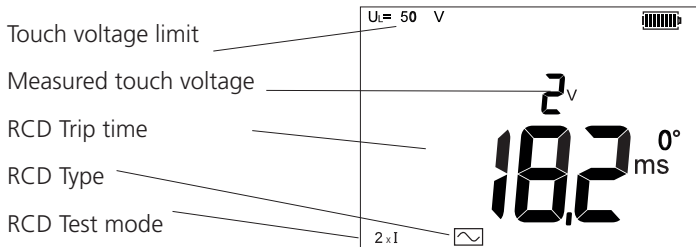

4. Press the \leftrightarrow mode button to select 180°.
5. Repeat the above test.

Record the higher of the two values:

- >150 ms = RCD FAILED (no trip)
- <150 ms = RCD Passed

8.6 5 x I RCD current rating (Tripping test on 30 mA RCD)

Repeat the test sequence in 8.5 but with the LEFT rotary range knob to the **5I** RCD test range.

1. Press the \leftrightarrow mode button to select 0°.
2. Press the TEST button.
The display should show one of the following:
*any value below 40 ms indicates an RCD has tripped in an adequate time.

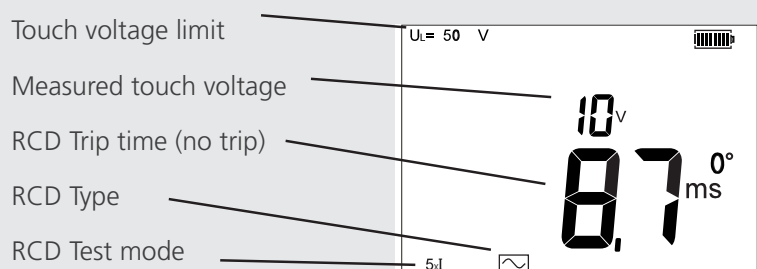

3. Press the \leftrightarrow mode button to select 180°.
4. Repeat the above test.

Record the higher of the two values:

- >40 ms = RCD FAILED (no trip)
- <40 ms = RCD Passed

8.7 Ramp test

The RCD trip current is measured by applying a test current of half the rated trip current and increasing this every 300 ms (or 500ms for type S RCDs) from 30% to 110% of the RCD current rating. When the RCD trips, the current flowing is recorded and displayed in mA.

Making a measurement

1. Select the appropriate RCD rated current on the right hand rotary switch **30** = 30 mA etc.
2. Select the RAMP test on the left hand range knob.

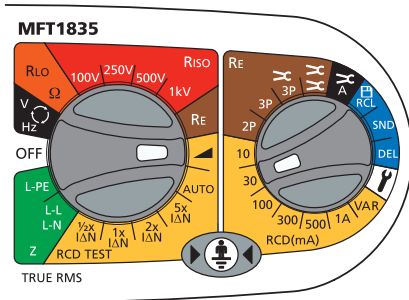

3. Press the TEST button
The RCD should trip and the display show the trip current in mA.

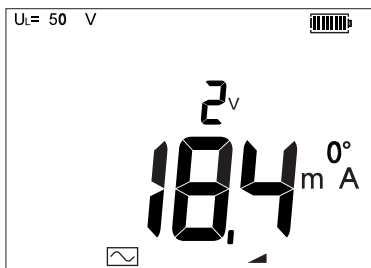

If the RCD fails to trip, >***mA is displayed, where *** = 110% of the nominal RCD trip current.

8.8 Fast Ramp Test

Fast ramp test can be selected in Setup (See **"11. Setup options"** on page 53)

The fast ramp test tests that the RCD will trip between 1/2I and 1xI of the rated RCD trip current. This allows faster testing and higher test currents to be used repeatedly, without overheating the instrument. The duration of each ramp step is less than the 300ms required in EN 61557. As such this test should not be used if compliance to EN61557 is required. Testing is the same as the standard ramp test.

8.9 Type A (DC Sensitive) RCD test

'Type A' RCDs are sensitive to pulsed DC as well as AC fault currents, and are tested with a pulsed waveform. The RMS current is $\sqrt{2}$ x the rated operating current of the RCD. As with the normal RCDs, these should be tested with 0° and 180° polarity.

1. To select a Type A RCD see **"8.2 Selecting RCD type"** on page 38



These are tested in exactly the same manner as those tested in **8.3 on page 39** to **8.7 on page 42**.

NOTE : Type A RCDs should be tested at 0° and 180° on 1/2xI, 1xI and 5xI

8.10 Type B (Pure DC) RCD test (Not MFT1815)

'Type B' RCDs are sensitive to pure DC fault currents, as well as pulsed AC and ordinary AC fault currents. First they are tested as Type A then Type B, using a pure DC test current.

Type 'B' RCD's are only tested on the 1xl range. The result displayed in milli-seconds (ms).

1. Test the RCD in 'Type A' mode for 1/2xl , 1xl and 5xl if it is a 30 mA RCD. Test it in 1xl only if it is > 30 mA.
2. To select a Type B RCD press and hold the mode button  repeatedly until the  symbol is displayed.
3. Connect the Red (L1), Green (L2) and Blue (L3) terminals of the MFT to the RCD Live, Neutral and Earth as below ('Type AC' and 'Type A' RCD's only need Phase and Earth connections).

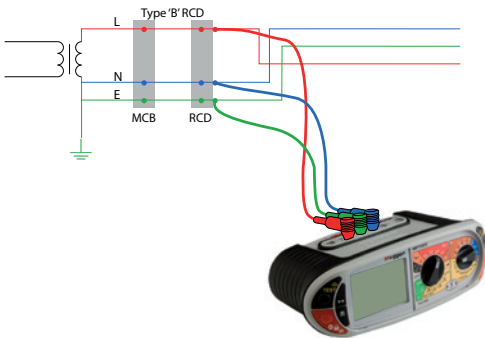

4. Select the 1xl range on the left range knob, and the current rating of the RCD on the right range knob.
5. Press the TEST button.
6. The RCD should trip and display the trip time in ms. The "Touch Voltage" is displayed on the small digital readout. The trip current in mA can be measured for Type B RCD's using the ramp test.

NOTE : Only 1xl is available. Selecting other test currents will reset the test type to AC. Only 10 mA, 30 mA, 100 mA and 300 mA test options are available on DC testing.

8.11 Variable RCDs (not MFT1815)

1. To test an RCD with a variable trip current, select the **VAR** option on the secondary (right) range knob.
2. Press the  MODE button to select the  symbol.

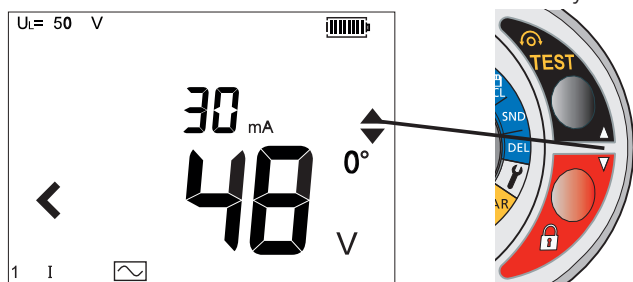

3. Use the UP and DOWN arrows on the right hand TEST and LOCK buttons to set the tripping current to match that on the variable RCD.

The tripping current can be selected as below;

10 mA to 50 mA	– 1 mA steps
50 mA to 500 mA	– 5 mA steps
500 mA to 1000 mA	– 10 mA steps

Save this current using the left hand Red LOCK button.

Test using the previous test options in 8.4 (see **“8.4 1 x I RCD current rating (Tripping test on 30 mA RCD)” on page 40**).

8.12 AUTO RCD testing

The AUTO function of the RCD test options automatically performs the 1/2xI, 1xI, 2xI and 5xI in both 0° and 180°, without touching the MFT. The operator can stand by the RCD and reset the device each time it trips.

Test sequence in AUTO mode:

RCD Type	AC	AC - S	A	A - S	B
1/2 x I at 0°	✓	Not available	✓	Not available	Not available
1 x I at 0°	✓		✓		
1 x I at 180°	✓		✓		
2 x I at 0°	✓		✓		
2 x I at 180°	✓		✓		
5 x I at 0°	✓		✓		
5 x I at 180°	✓		✓		

To test the RCD in AUTO mode

4. Select the AUTO range on the left range knob
5. Select the RCD Type as in **“8.2 Selecting RCD type” on page 38**.
6. Connect the Red (L1) and Green (L2) terminals of the MFT to the RCD as in **8.3 on page 39**
7. Press the TEST button on the MFT. The test sequence as in the table above will be performed.

Each time the RCD trips, it should be reset. The MFT automatically detects the reset and continues testing until the RCD stops tripping. The MFT will display “END”

8. Return to the MFT and press the mode  button to scroll through the test results in sequence.

8.13 3 Phase RCD testing

The MFT1800 series is designed to test RCDs on 3 phase installations.

To test RCDs in a 3 phase system each RCD is tested as a single RCD, from Phase to earth. As described in **“8.1 Making an RCD measurement” on page 38** to **“8.6 5 x I RCD current rating (Tripping test on 30 mA RCD)” on page 41**.

Where no earth is available, the upstream/downstream method can be used. This requires testing across two phases, as below.

1. To test Phase 1 RCD, connect the MFT Red (L1) terminal to the downstream (o/p) of the RCD to be tested.
2. Connect the Green (L2) terminal of the MFT to the upstream phase of an RCD on a separate phase.

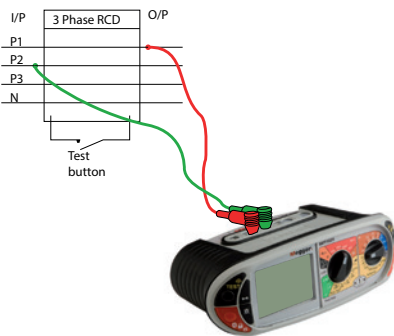

3. Press the TEST button.
4. The MFT will display the trip time of the RCD.

8.14 Touch voltage display

The voltage to which an earth conductor may rise during an RCD test. The limit for touch voltage is 50 V AC or 25 V AC, depending on the environment.

Touch voltage is caused by excessive resistance in the earth circuit when a load is placed between the live and earth conductors.

Touch voltage is displayed:

- at the end of an RCD test if the voltage is below the safe limit
- before an RCD test is started if it would exceed the safe limit.

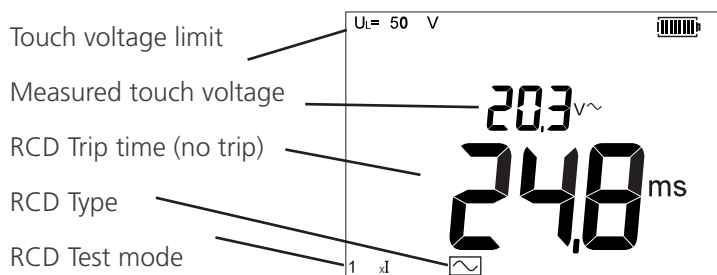

Touch voltage is calculated using the nominal trip current of the RCD x Earth resistance. For example:

$$\text{RCD trip current} = 30 \text{ mA}$$

$$\text{Earth resistance} = 1000 \Omega$$

$$0.03 \text{ A} \times 1000 \Omega = 30 \text{ V}$$

If the calculated touch voltage is less than the Touch voltage limit, the RCD test will proceed. If it is greater than the limit set, the test is halted.

The Touch Voltage limit is set in section - UL 25 V, 50 V, 60 V

NOTE : The touch voltage is always displayed using the nominal trip current of the RCD (ie 1xI).

Residual Current Device (RCD) or Ground Fault Current Interrupt (GFCI) testing

If using the 1/2xl, 2xl or 5xl test ranges, the touch voltage will still be displayed for 1xl test current, as per IEC 61557-6.

2xl and 5xl can create real touch voltages during the tests that are higher than the displayed value. If this voltage exceeds the touch voltage limit (UL) the test will be stopped.

Under these conditions the display will show the calculated touch voltage on the small digital segments and >50 V on the larger digital segments, as below:

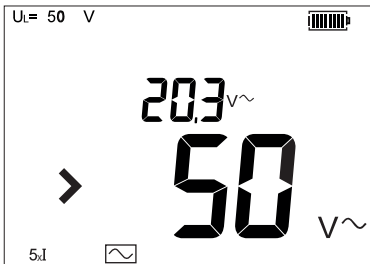

8.15 Measurement methods and sources of error

RCD Testing - Method of measurement

A two wire lead, or mains plug lead should be used for this measurement. A constant current source is connected across the supply and the time taken for the supply to trip is measured by the instrument in ms.

RCD Testing – Possible sources of error

Measurement results can be affected by the following:

- Significant operating errors can occur if loads, particularly rotating machinery and capacitive loads, are left connected during tests.
- A poor connection to the circuit under test.

8.16 Useful information

It is only necessary to test the 10 mA and 30 mA at 1/2xl, 1xl and 5xl. All other RCDs only need to be tested at 1/2xl and 1xl.

Always press the RCD TEST button on the RCD to ensure the function works.

It is recommended the RCD test button is tested AFTER the timing tests above are complete. This can identify RCDs that may stick or fail if not checked periodically.

9. Testing of Electric Vehicle Charge Point RCD's (MFT1845+ only)

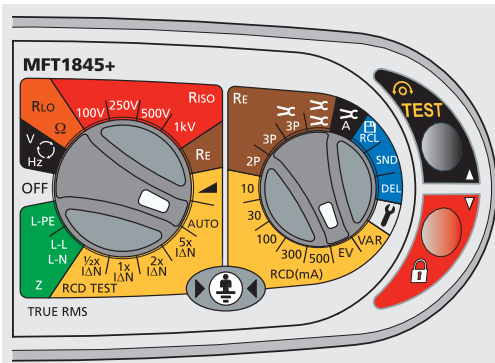

Figure 8: Switch settings

To test an Electric Vehicle charger (EV) RCD. The sequence will automatically run the following in Auto EV mode:-

EV Type	AC	B
½ x I at 0°	✓	X
½ x I at 180°	✓	X
1 x I at 0°	✓	X
1 x I at 180°	✓	X
5 x I at 0°	✓	X
5 x I at 180°	✓	X
DC RAMP 0°	X	✓
DC RAMP 180°	X	✓

EV RCD Table

1. Select the auto option on left range knob (see Figure 8).
2. Select the EV option on right range knob (see Figure 8).
3. Connect the red (L1), green (L2) and blue (L3) to the MFT.
4. Connect the opposite ends of the test leads to the RCD protected EV circuit*.
5. Ensure the MFT shows the circuit is live as in Figure 9 below:

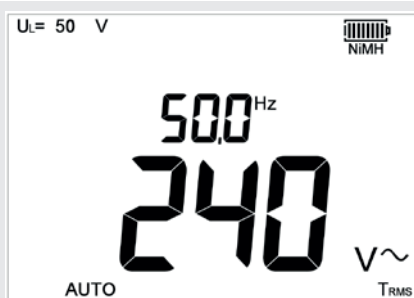

Figure 9: Instrument displaying that the circuit is live.

NOTE : If no supply voltage is shown, check the status of the electrical supply to the EV charging point and ensure the RCD is switched on.

NOTE : If N < > L is displayed, the live and neutral are reversed. For MFT1800 series, the test should proceed as normal. For MFT1800 series, the test will be aborted. Check connection to the instrument and change to the charge point.

1. Press the TEST button on the MFT. The test sequence will run as in EV RCD Table shown above.
2. On completion of the test, the display will show "End" in small letters

Testing of Electric Vehicle Charge Point RCD's (MFT1845+ only)

During the test sequence:

- The 1xl, 5xl and DC Ramp will trip the RCD.
- Some EV charge points will auto-reset the supply voltage each time the RCD trips. In this case the MFT will automatically proceed to the next test.
- Older EV charge points do not always reset automatically.
- In this case, the charge point will need to be reset manually.
- To reset the charge point power the most convenient option is to use the Megger EV charge point adaptor (part number 1012-732 (see **"20. Accessories" on page 67**).
- Alternatively, remove the power from the charge point and re-connect.

The Megger MFT can be connected to the EV charge point adaptor using the optional Megger charge point adaptor, part number 1012-732 (see **"20. Accessories" on page 67**).

Refer to the user guide for the adaptor for further details.

Visit: [megger.com/electrical-vehicle-charge-point-adaptor-evca210](https://www.megger.com/electrical-vehicle-charge-point-adaptor-evca210)

On conclusion of the test sequence, the test results can be reviewed by pressing the function key to cycle through each result, or saved to memory and can be reviewed at a later date.

Always reset the RCD after testing, if it has not automatically reset.

10. Earth resistance measurement

The Megger MFT family of test instruments offer a unique solution to the measurement of earth or ground electrode (rod) supporting 2 and 3 wire measurements:

The MFT1835 and MFT1845+ can use an optional current clamp (MCC1010) to measure electrode (rod) resistance without disconnection, leaving the installation earthing system intact (Attached Rod Technique, ART). Additionally, they can drive an optional voltage-inducing clamp (MVC1010) which, in conjunction with the MCC1010, can be used to make stake-less measurements of the earthing system.

For the principles of Earth resistance testing see **"18. Appendix F - Earth resistance testing – Basic principles"** on page 62

10.1 Connection terminals

The terminal references used on the MFT are:



The terminal colours correspond to the Earth test lead set, **not the standard test leads** shipped with the MFT1800 series.

MFT1835 and MFT1845+ Connection panel

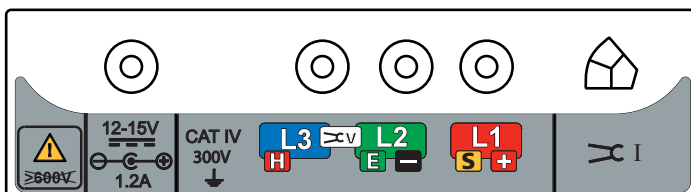

10.2 Touch voltage limit

Adjust the touch voltage limit to 25 V or 50 V depending on location. **"11. Setup options"** on page 53.

10.3 Making a measurement - Two pole resistance measurement

1. Connect the instrument as shown below.

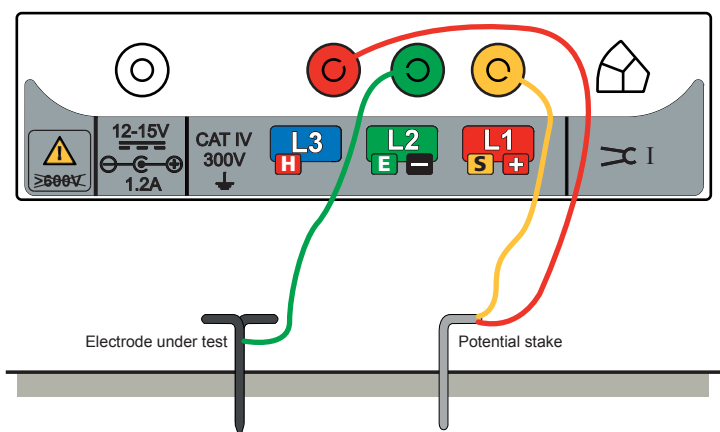

Earth resistance measurement

- Set the rotary selector switch to the **2P** position.

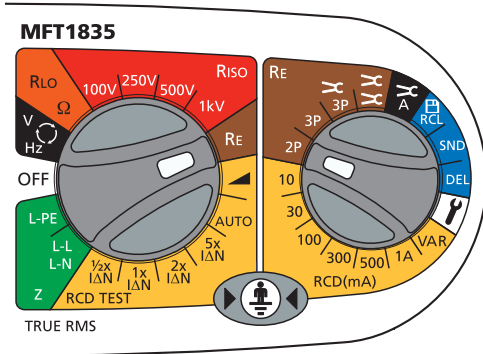

- Press and release the **TEST** button.

The instrument will perform pre-measurement check, the status of which will be indicated on the display. The two-terminal resistance reading will be displayed

NOTE : The test voltage used to make the two-terminal resistance reading is AC and may not be suitable for continuity testing according to some local regulations.

10.4 Making a measurement – Three terminal resistance measurement

- Connect the instrument as below.

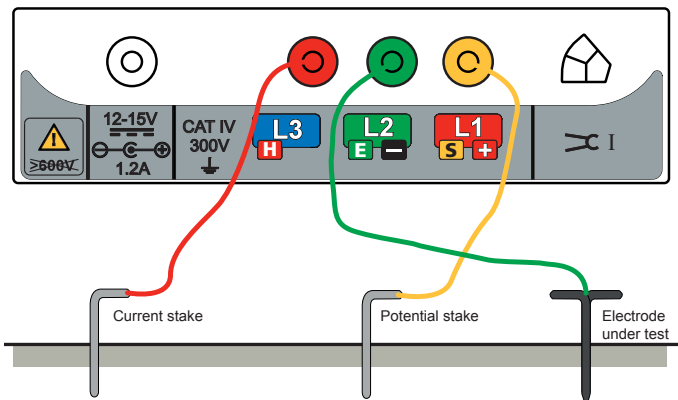

- Set the rotary selector switch to the **3P** position.

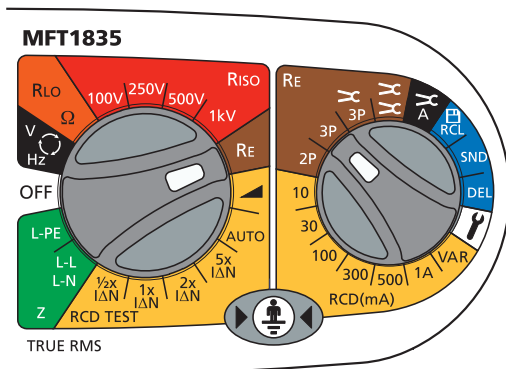

- Press and release the **TEST** button.

The instrument will perform pre-measurement check, the status of which will be indicated on the display. The three-terminal resistance reading will be displayed.

10.5 Making a measurement – Three terminal resistance measurement using ART

1. Connect the instrument as BELOW. Position the MCC1010 below the point where the Green Lead is attached to the Earth Conductor. In practice the MCC1010 can be positioned directly on the Electrode under test, at a point below where the green Lead is attached to the the Earth conductor.

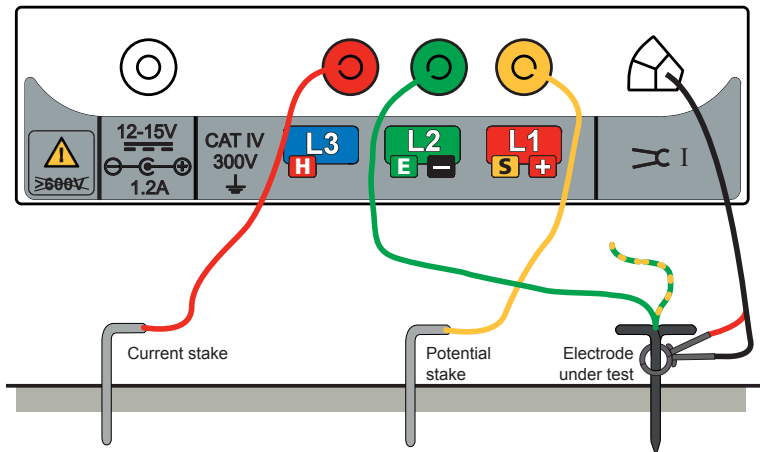

2. Set the rotary selector switch to the **3P**  position.

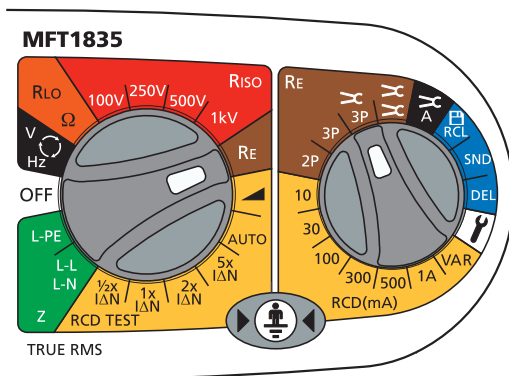

3. Press and release the **TEST** button [by holding the **TEST** button, the resistance measurement will be continually updated].

The instrument will perform pre-measurement checks, the status of which will be indicated on the display. The three-terminal resistance reading using ART will be displayed

Under certain circumstances, the instrument may display a noise warning. This means that interference has been detected which may impair the accuracy of the measurement. In particular, the reading could be lower than the actual resistance. The resistance of the electrode or system must be verified by an alternative method.

NOTE :

- The instrument will display the warning triangle and an excessive noise voltage indicator if the ground noise voltage is above 20 V pk-pk (7 Vrms).
- The instrument will display the warning triangle above 2 A – no ART testing is possible under this condition.
- The instrument will display the warning triangle and an over-range condition above 20 A – no ART testing is possible under this condition.
- Ensure that the MCC1010 jaw mating surfaces are free of dust and contamination and that they contact completely when the MCC1010 is closed.
- Currents carried by conductors in close proximity to the MCC1010 may affect calibration and reduce the accuracy of measurements made.
- Re/Rs ratio must be less than 100, where Re = Earth resistance, Rs = Shunt resistance

10.6 Two-clamp stake-less measurement (MFT1835 and MFT1845+ only)

Before making a stake-less measurement, please follow the procedures contained in the calibration section of the **MCC1010 User Guide**.

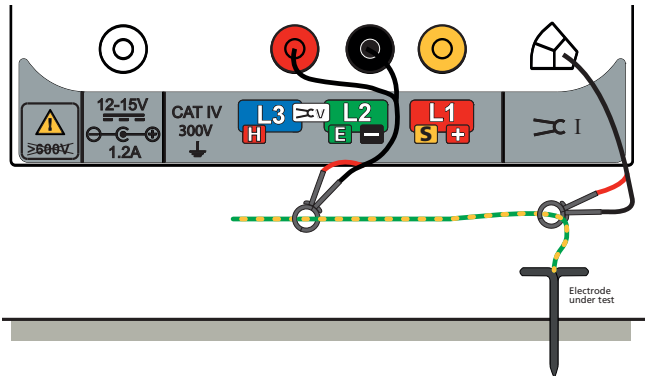

1. Ensure the rotary selector switch is in the **OFF** position.
2. Connect the instrument as shown above.
3. With this method, the MCC1010 may be positioned directly around the Electrode under test or around the Earth Conductor itself. The MCC1010 should be positioned below the MVC1010. Ensure the arrow on the side of the jaw is pointing in the same direction as the arrow on the MVC1010.
4. Close the MVC1010 around the conductor under test. Ensure the arrow on the side of the jaw is pointing in the same direction as the arrow on the MCC1010.

(If one of the clamps is reversed, the main display shows 'Err' momentarily with 'REV' on the auxiliary display together with the MVC1010 symbols).

5. Ensure a minimum separation of 100 mm between the MCC1010 and MVC1010.
6. Set the rotary selector switch to the  position.

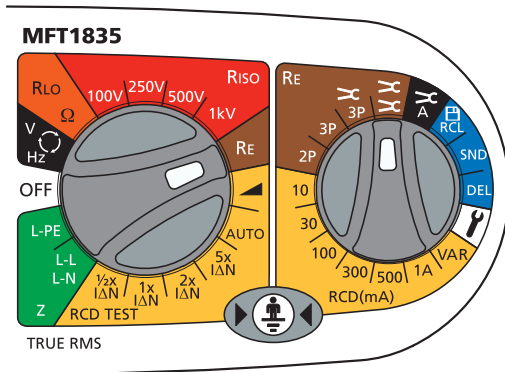

7. Press and release the **TEST** button. The instrument will perform pre-measurement checks, the status of which will be indicated on the display.
8. The stake-less resistance reading will be displayed.

NOTE :

- The instrument will display the warning triangle above 2 A – no “Stakeless” testing is possible under this condition.
- Ensure that the MVC1010 and MCC1010 jaw mating surfaces are free of dust and contamination and that they contact completely when the MVC1010 and MCC1010 are closed.
- Currents carried by conductors in close proximity to the MVC1010 and MCC1010 may affect calibration and reduce the accuracy of measurements made.
- If the MVC1010 opens at any time after the **TEST** button is pressed, the test will be aborted.

11. Setup options

The Setup options allow the MFT to be configured to best suit the type of testing to which it will be used. To enter Setup, right (secondary) range knob to  Setup. Set the left (primary) range knob to any function other than OFF. The display will show **VER** and the software version number. It will then change to the first message in the list below:

Message	Function	Options	Factory setting
RST	Restore factory settings	NO / YES	NO
INS* ¹	Insulation limit alarm – Buzzer sounds if result is higher than limit set	0.5, 1, 2, 3, 4, 5,7, 10, 50, 100, 500 MΩ	1 MΩ
LOC	Insulation test lock.	ON / OFF	ON
bUZ	Continuity limit alarm – Buzzer sounds if result is below than limit set	0.5, 1, 2, 5, 10, 50, 100 Ω	2 Ω
ISC* ²	Continuity test current	15 mA / 200 mA	200 mA
REV	Auto reverse continuity test	ON / OFF	OFF
loop	Loop test lead compensation	0 – 0.3 ohms	0.07 Ω
LAS	Loop test AUTO start	ON/OFF	OFF
L-PE 2Hi	Enable/Disable high current loop test	ON/OFF	ON
L-PE 2Lo		ON/OFF	ON
RAS	RCD AUTO start	ON/OFF	OFF
RRA* ³	RCD Ramp test Nor = Normal, FST=Fast	Nor / FST	Nor
UL	Touch voltage limit	25 V / 50 V / 60 V	50 V
N –L	Reverse Polarity Loop test enable ON= Loop test allowed OFF= Loop test stopped	ON/OFF	OFF
OFF	Auto switch OFF in minutes	2 m / 20 m	20 minutes
bAt	Alkaline or NiMH selection	1.5 V or 1.2 V	Depending on instrument
StR	Store mode IN = Internal Bt = Bluetooth® only	IN / bT	IN
bt	Bluetooth® pairing	bt1, bt2, bt3, bt4, bt5	bt1
< >	Searching for pair		

INS*¹ is not available on MFT1815

ISC*² is not available on MFT1815

*3RRA is only available on MFT1800 series

To scroll down the options, press the  button. Each option will be is played in sequence.

To change the setting of each function, for example, INS limit alarm from 1 MΩ to 2 MΩ, use the right hand TEST and LOCK keys (also marked with UP/DOWN arrows).

Changing an option will set the LOCK symbol and warning triangle flashing.

To save the change press the left LOCK button

To exit SETUP, turn the right range knob away from 

All settings can be restored to the factory defaults by setting RST to YES. Saving this setting will reset all options to default. The RST will then set back to NO.

12. Warning messages

The following warning messages may be displayed during the testing process.

Characters which appear in the aux (small) digit field on the display are shown here in a slightly smaller font size.

12.1 Startup warnings

"UNC" -Instrument is un-calibrated

12.2 Battery

"bAt" -Low battery

12.3 Battery charger

"bAt CHA" -Battery charging

"bAt FUL" -Battery fully charged

12.4 Fuse warning

"FUS" -Fuse blown.

12.5 Invalid rotary switch setting

"ERR - - -" -General error – invalid combination of rotary switches.

12.6 Continuity test

"VOL 0-L" -Voltage overload during test

12.7 Insulation test

"1000 V 1000 V" -Flashing warning before 1 kV test.

"VOL 0-L" -Voltage overload during test

12.8 RCD Test (or GFCI)

"trp" -Supply tripped unexpectedly.

">50V" -Test aborted due to danger of exceeding touch-voltage limit.

"Err con" -Hardware problem detected during High Current Loop test or RCD test.

12.9 RCD range selection errors

"ERR >1000 mA"	-Requested current is >1000 mA.
"ERR - - -" + Type A	-In Type A mode -Instrument has been set for Type A test, but Type A test is not valid with this setting.
"ERR - - -" + Type B	-In type B mode - Instrument has been set for Type B test, but Type B test is not valid with this setting.
"ERR - - -" + Type S breaker symbol	-Instrument has been set for Type S test, but Type S test is not valid with this setting.
"ERR HI mA"	-On VAR range, current is set too high for the selected test.

12.10 Loop Test

"trp"	-Supply tripped unexpectedly.
">50V"	-Test aborted due to danger of exceeding touch-voltage limit.
"Err con"	-Hardware problem detected during High Current Loop test or RCD test.
"Hot"	-Internal resistors are too hot. Also shows thermometer.
"Hot"	-Internal heat sink is too hot. Also shows thermometer.
~	-Supply noise detected. Loop test time will be extended.

12.11 Earth test

"Err REv"	- During a 2-clamp test, one clamp is the wrong way round.
"Err" + MVC1010 symbol	-During a 2-clamp test, the MVC1010 has been opened.
"Err" + MCC1010 symbol	-During an ART test, the MCC1010 is the wrong way round.
"Err" + Rp symbol	-Rp resistance is too high.
"Err" + Rc symbol	-Rc resistance is too high.

12.12 Test will not start

"CON"	-Wrong connection to instrument.
"hot"	-Internal resistors are too hot. Also shows thermometer.
"Hot"	-Internal heat sink is too hot. Also shows thermometer.
"VOL >280V" (for example)	-Supply voltage is too high.
"L-N <48V" (for example)	-Voltage on terminals is too low for L-N loop test
"L-E <48V" (for example)	-Voltage on terminals is too low for L-E loop test or RCD test
"FRE <45"	-Supply frequency is too low for loop test or RCD test
"FRE >65"	-Supply frequency is too high for loop test or RCD test
"NO REF"	-Loop R1+R2 test attempted without having previously done a Zref test.

13. Appendix A – Sending, Storing, Deleting and Recalling Test Results (MFT1835 and MFT1845+)

Test results can be stored in the MFT, or downloaded immediately to a Bluetooth® compatible device, or both.
See “11. Setup options” on page 53,

Test results are stored in “Folders” against a set of circuit references as below:

Folders:

Jb	000 to 255	Job number – Allows results from different locations to be saved in one instrument
Db	001 to 255	Distribution board number
CIR	000 to 255	Circuit reference number
PHA	001 to 003	Phase number

Circuit type:

In addition, the following circuit descriptors are used to identify on which part of the circuit the measurement was made:

Insulation:

Symbol	Definition
L – E	Live to Earth Test
L – N	Live to Neutral Test
N – E	Neutral to Earth Test
L – L	Live to Live Test
- - -	No connection selected

Continuity:

Symbol	Definition
R1	Live
R2	Circuit Protective Conductor
R12	R1 + R2
RR1	Ring Circuit Phase-Phase
RR2	Ring Circuit CPC-CPC
RRN	Ring Circuit Neutral-Neutral
- - -	No connection selected

Loop Testing:

L-E range measurements are automatically saved as L-E connections

L-N range

Symbol	Definition
L – E	Live to Earth Test
L – N	Live to Neutral Test
L – L	Live to Live Test

RCD/GFCI:

Not relevant

Earth testing:

Earth measurements are saved under a job number only

Storing Test Results in the internal memory

NOTE : Note that in order to store test data, the Store Mode needs to be set to internal or internal and Bluetooth®. See “11. Setup options” on page 53.

1. Perform the desired test as described previously.
2. Press and release the Bluetooth® (Lock) button to display the first option. This will be the connection for some tests (Insulation, Continuity, Loop L-L/L-N) or Job number for other tests.
3. Use the Right Lock / RIGHT TEST buttons to scroll through the values until the one you need is reached.
4. Press and release the Bluetooth® (Lock) button again to display each of the remaining options (Job, Distribution Board, Circuit, Phase) and use the Right Lock / RIGHT TEST buttons to change these values as required.
5. To complete the store, press and hold the Bluetooth® (Lock) button until ‘Str Ok’ is displayed.

Notes

1. If a particular option does not need to be changed from the value set during the previous stored result, it does not need to be displayed prior to storage.
2. The only available option for stored Earth test results is the Job number.

Deleting Test Results from the internal memory

1. Turn the RIGHT rotary range knob to the DEL range.
2. Use the Bluetooth® (Lock) button to select either LSt (last stored result) or ALL (all stored results).
3. Press and hold the Bluetooth® (Lock) button until ‘NO’ is displayed.
4. Use the Right Lock / RIGHT TEST buttons to display ‘YES’.
5. Press and hold the Bluetooth® (Lock) button until ‘dEL Ok’ is displayed.

Recalling Test Results to the display

1. Turn the RIGHT rotary range knob to the RCL range.
2. Use the Bluetooth® (Lock) button to select either LSt (last stored result) or ALL (all stored results).
3. Press and hold the Bluetooth® (Lock) button until the result is displayed on the screen.
4. If ALL has been selected, use the Right Lock / RIGHT TEST buttons to scroll through the stored results.
5. If TEST is displayed, this indicates further data is available for the displayed result. Use the LEFT TEST button to display this as required. E.g. for Insulation, the test voltage is available for viewing.

Sending stored test results via Bluetooth®

1. Run Megger Download Manager
2. Using the appropriate driver, follow the on-screen instructions.

Appendix A – Sending, Storing, Deleting and Recalling Test Results (MFT1835 and MFT1845+)

Sending stored test results via Bluetooth®

1. Run **Megger Download Manager**
2. Using the appropriate driver, follow the on-screen instructions.

Sending individual (Blobbing) Test Results

Note that in order to Blob test data, the Store Mode needs to be set to Bluetooth or Internal and Bluetooth. See **“11. Setup options” on page 53**.

To force a particular test result into a specific certificate box double click the box within the certificate prior to Blobbing the result.

Insulation testing

1. Perform an Insulation test as described previously.
2. Press and hold the Bluetooth® (Lock) button to display the first option. Release button when L-E displayed.
3. Use the Right Lock / RIGHT TEST buttons to scroll through the options until the one you need is reached (L-E, L-n, n-E, L-L or ---).
4. Press the Bluetooth® (Lock) button to send the test result to your PC or mobile device. The display chevrons will alternate whilst the connection is being established. When connected, the Bluetooth® symbol will flash whilst the result is transmitted.
5. The test results will now appear in the correct box in the certificate open on your PC or mobile device.

Continuity testing

1. Perform a Continuity test as described previously.
2. Press and hold the Bluetooth® (Lock) button to display the first option. Release button when R12 is displayed.
3. Use the Right Lock / RIGHT TEST buttons to scroll through the options until the one you need is reached (R2, R12, R1, RR1, RR2 or ---).
4. Press the Bluetooth® (Lock) button to send the test result to your PC or mobile device. The display chevrons will alternate whilst the connection is being established. When connected, the Bluetooth® symbol will flash whilst the result is transmitted.
5. The test results will now appear in the correct box in the certificate open on your PC or mobile device.

Loop testing (L-PE)

1. Perform a Loop test as described previously.
2. Press and hold the Bluetooth® (Lock) button to send the test result to your PC or mobile device. Release the button when the display chevrons start to alternate. This indicates the connection is being established. When connected, the Bluetooth® symbol will flash whilst the result is transmitted.
3. The test results will now appear in the correct box in the certificate open on your PC or mobile device.

Loop testing (L-L/L-N)

1. Perform a Loop L-L/L-N test as described previously.
2. Press and hold the Bluetooth® (Lock) button to display the first option. Release button when L-N displayed.
3. Use the Right Lock / RIGHT TEST buttons to scroll through the options until the one you need is reached (L-N or L-L).
4. Press the Bluetooth® (Lock) button to send the test result to your PC or mobile device. The display chevrons will alternate whilst the connection is being established. When connected, the Bluetooth® symbol will flash whilst the result is transmitted.
5. The test results will now appear in the correct box in the certificate open on your PC or mobile device.

RCD testing

1. Perform a RCD test as described previously.
2. Press and hold the Bluetooth® (Lock) button again to send the test result to your PC or mobile device. The MFT test result will flash whilst the result is transmitted.
3. The test results will now appear in the correct box in the certificate open on your PC or mobile device.

For Auto RCD tests all results are automatically transmitted to the correct boxes on the certificate (the appropriate value must be selected on the PC or mobile device for each box when prompted).

Earth testing

1. Perform an earth test as described previously
2. Press and hold the Bluetooth® (Lock) button again to send the test result to your PC or mobile device. The MFT test result will flash whilst the result is transmitted.
3. The test results will now appear in the correct box in the certificate open on your PC or mobile device.

Continued...

14. Appendix B – Downloading data via Bluetooth® (MFT1835 and MFT1845+)

Bluetooth® Pairing (PC or Laptop)

1. Turn your MFT 'on' to any setting, and turn the smaller dial to the settings ('spanner') position to enter the setup mode.
2. Press the  button on the MFT until you see 'StR' appear on the display. At this point you should ensure that 'bt' is displayed in larger letters on the main part of the MFT's display.

If this is not the case use the right-hand TEST & Lock buttons as UP/DOWN arrows to scroll through the options to select your chosen communication method.

- IN = Internal Only
- bt = Bluetooth® Only

Once you have selected your chosen storage/communication location, press the left hand Bluetooth®/Lock button once to save this as your preference. The Lock icon will now stop flashing in the upper left hand corner of the MFT's display and disappear to indicate your preference has been saved.

3. You will now need to press the  arrow once to display the 'bt' setup option.
4. To enter the Bluetooth® pairing mode you will now need to push and hold down the left hand Bluetooth®/Lock button until you see two oscillating chevrons (<>) appear on the display and then release. The Bluetooth® pairing will fill the first empty slot available, if there are no empty slots left, it will overwrite the currently shown slot on the MFT's display. If all slots are currently in use and you wish to add another, display on the screen the slot that you want to overwrite. To do this use the right-hand TEST & Lock buttons as UP/DOWN arrows to scroll through all 5 slots.
5. From your PC/Laptop run the 'Add Bluetooth® Device' wizard.
 - You will be prompted during the pairing process to enter your passkey, enter '1234'
 - During the pairing process you may also be prompted to enable the 'Bluetooth® Serial Port'. Ensure this option is chosen if you are given this option.
6. Once you have clicked 'Finish' on the wizard on the PC/Laptop the pairing process will now be complete and your PC/Lap-top pairing code will be displayed on the MFT. You can now turn the dial and leave the settings ('Spanner') position on the MFT.

15. Appendix C - Installation category definitions

IEC 61010-2-030 defines measurement categories II to IV relating to transient over-voltages and locations within electrical installations.

Examples of electrical installation category rating are:

Category II - a mains socket outlet,

Category III - the wiring between the socket outlets and the consumer unit,

Category IV - the supply to the consumer cut-out from the distribution network transformer.

For further information on category ratings visit the relevant product page on www.megger.com.

16. Appendix D - Safe working practice

It is important that before the instrument is used, and when testing is completed, the functions of the instrument are proven to be working. This is to ensure that a hazardous condition is not mis-reported by the instrument as being safe. For example:

By checking the voltage range correctly measures 230 V AC on a separate electrical source, prior to measuring the circuit to be tested, and then checking it at the end of testing, a live circuit is less likely to be mis-reported as dead.

The Megger MTB7671 test box is available for checking all electrical functions of the multi-function tester (excluding earth tests) between calibration dates.

17. Appendix E - Cleaning and maintenance

The MFT1800 should only be opened or repaired by an approved Megger service or by Megger Instruments Limited. To clean the instrument, use a damp cloth or isopropyl alcohol if available. To clean the display window only use a lint free cloth.

For repairs and warranty, see **"21. Repair and Warranty"** on page 68.

18. Appendix F - Earth resistance testing – Basic principles

18.1 F.1 Principle of operation (three-terminal resistance measurement)

The classic “fall of potential” test is used to accurately measure the resistance of an earth electrode using auxiliary stakes driven into the soil, which form a circuit for the test current injection and voltage measurement as used for the two-terminal method.

The MFT injects an AC current of known magnitude into the system under test and measures the voltage developed across it as shown in Figure 4. The system resistance is a simple ratio as per ohm’s Law. In this case, the potential stake is moved by fixed increments in a straight line between the electrode under test and the current stake. At each location, the resistance is calculated as $R=V/I$. A graph of resistance versus potential stake position is plotted and the resistance of the electrode under test is taken to be the point at which the curve is flattest.

Empirical testing has shown that with suitably positioned stakes, this method can be shortened by placing the potential stake at a distance of approximately 62% between the electrode under test and the current stake, i.e. at $A = 0.62 \times B$.

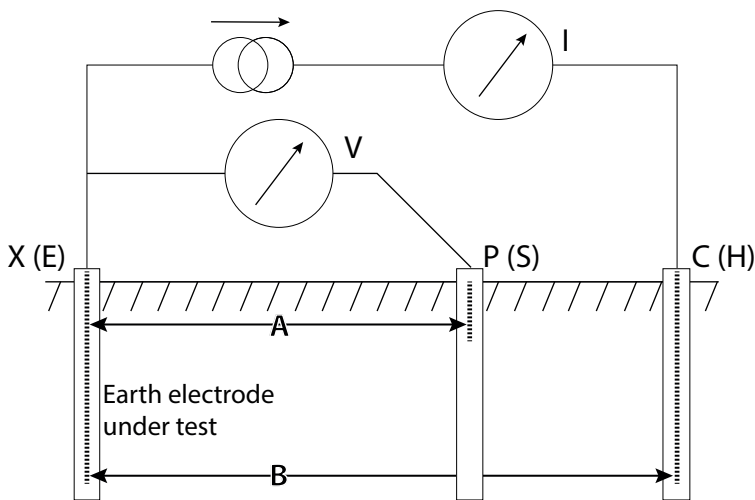

Figure 10: Schematic for three-terminal resistance measurement

18.2 F.2 Principle of operation (three-terminal resistance measurement using ART)

The classic three-terminal test method has a disadvantage, namely that the electrode under test must be disconnected from the system it is supposed to protect in the event of a power system fault. The reason for this is that the injected test current will take all possible routes to ground and not all of it will necessarily flow through the electrode under test. In this case, the instrument will make a reading of the entire earthing network, not just the individual electrode.

By using a current transducer (the Megger MCC1010) to measure the current flowing through the electrode under test as a fraction of the total test current injected, the instrument can determine the individual resistance. This arrangement is shown in Figure 11.

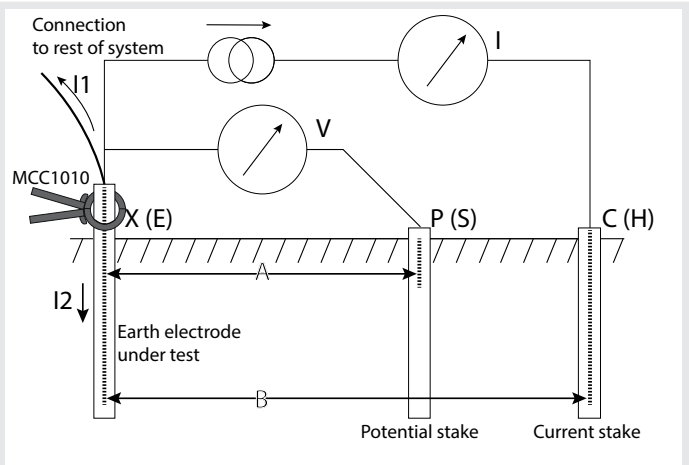

Figure 11: Schematic for three-terminal resistance measurement using

In this configuration, the injected test current I splits along two paths into I_1 (flowing into the connected earthing system) and I_2 (flowing into the electrode under test, i.e. $I=I_1+I_2$). The resistance of the electrode under test is calculated as $R=V/I_2$ or $R=V/(I-I_1)$. The current transducer (MCC1010) measures I_2 and feeds this value back to the instrument.

18.3 F.3 Principle of operation (two-clamp stake-less resistance measurement)

In this example, the electrode under test is connected to a network of other electrodes. It is either impractical or unsafe to disconnect an individual electrode for testing. Also, there might be insufficient space to perform a classic three-terminal resistance measurement. The stake-less test method using both MVC1010 and MCC1010 can be used to obtain a measurement for the electrode under test.

A defined test voltage is injected into the system using the MVC1010, inducing a current, I , to flow and be measured by the MCC1010. The model shown in Figure 7 can be simplified to the resistance of the electrode under test, R_x and the resistance of the other electrodes in parallel, i.e. $R_1 \parallel R_2 \parallel \dots \parallel R_n$.

Therefore, the current induced by the test voltage is $I=V/[R_x+(R_1 \parallel R_2 \parallel \dots \parallel R_n)]$. It follows that as the resistance of the other electrodes in parallel approaches zero, then the resistance measured, approaches the value of the electrode under test.

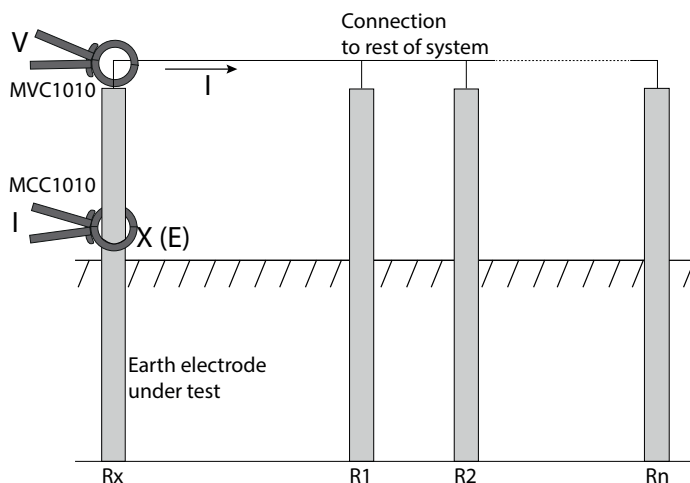

Figure 12: Schematic for two-clamp stake-less resistance measurement

19. Specifications

19.1 Accuracy

19.1.1. Insulation test

Specification	Detail
1000 Volts	10 k Ω - 999 M Ω \pm 3% \pm 2 digits
500 Volts.	10 k Ω - 500 M Ω \pm 3% \pm 2 digits >500 M Ω \pm 10% \pm 4 digits
250 Volts.	10 k Ω - 250 M Ω \pm 3% \pm 2 digits >250 M Ω \pm 10% \pm 4 digits
100 Volts.	10 k Ω - 100 M Ω \pm 3% \pm 2 digits >100 M Ω \pm 10% \pm 4 digits
EN61557 range:	10 k Ω - 999 M Ω (1000 V range)
Voltage display:	\pm 3% \pm 3 digits \pm 0.5% of rated voltage
Max service error:	\pm 15% \pm 2 digits.
Short circuit current:	1.5 mA nominal test current
Test current on load:	\geq 1 mA at min. pass values of insulation
Output voltage tolerance:	-0% +20% at rated load or less

19.1.2. Continuity / Resistance

Specification	Detail
Intrinsic accuracy:	\pm 2% \pm 2 digits (0.01 Ω to 99.9 Ω) \pm 5% \pm 2 digits (100 Ω to 99.9 k Ω)
EN61557 range:	0.1 Ω to 99.9 k Ω
Open circuit voltage	5 V \pm 1 V
Test current at 200 mA (0 Ω to 2 Ω):	>200 mA @ \leq 2 Ω
Test current at 15 mA (0 Ω to 2 Ω):	>15mA @ \leq 2 Ω
Max Service error:	\pm 12% \pm 2 digits.

19.1.3. Loop test 2Hi (L-PE, L-N, L-L):

Specification	Detail
Intrinsic accuracy:	\pm 5% \pm 3 digits
Display range:	0.01 Ω to 1000 Ω
Supply:	48 V to 480 V* (45 Hz to 65 Hz)
Test current high:	4.0 A (at 230 V)
PSCC range:	20 kA
EN61557 range:	0.30 Ω to 1000 Ω
Max service error:	\pm 10% \pm 2 digits
* MFT1711 280 V	

19.1.4. Loop test 3Lo, 2Lo (L-E):

Specification	Detail
Intrinsic accuracy:	0.01 Ω to 39.9 Ω \pm 5% \pm 5 digits 40.0 Ω to 999 Ω \pm 10% \pm 5 digits
Display range:	0.01 Ω to 1000 Ω
Supply:	48 V to 280 V (45 Hz to 65 Hz)
Test current:	Pulsed
PFC range:	20 kA
EN61557 range:	0.30 Ω to 1000 Ω
Max service error:	\pm 10% \pm 2 digits

19.1.5. RCD test:

Specification	Detail
Intrinsic current accuracy:	
No trip test:	(1/2xl) -10% to 0%
Trip test:	(1xl, 2xl and 5xl) +0% to +10%.
Ramp test current:	±5% ±1 digit
Trip time:	±1% ±1 ms
Programmable step increments:	10 mA to 50 mA – 1 mA steps. 50 mA to 500 mA – 5 mA steps 500 mA to 1000 mA – 10 mA steps.
Supply:	48 V - 280 V (45 Hz to 65 Hz)
Max service error:	±10% ±2 digits

19.1.6. Voltage

Specification	Detail
Intrinsic accuracy:	±2% ±1 V
EN61557-1 Range:	10 V to 600 V
Phase rotation indication.	
Max service error:	±5% ±2 digits

19.1.7. Frequency

Specification	Detail
Intrinsic accuracy:	±0.5% ±2 digits
Resolution:	0.1 Hz
EN61557 Range:	15 Hz to 400 Hz
Max service error:	±5% ±3 digits

19.1.8. Earth Test Ranges

Specification	Detail
Intrinsic accuracy:	±2.0% ±5 digits
ART method	±5.0% ±5 digits
Stakeless method	±7.0% ±5 digits
Resolution:	0.01 Ω
EN61557 range:	1.0 Ω to 1.99 kΩ
Current:	0.45 mA or 4.5 mA.
Noise rejection:	20 V pk/pk (7 V rms)
Max probe resistances:	R _p , R _c = 100 kΩ @ 50 V
Max service error:	±20% ±3 digits

19.1.9. Current (via Clamp meter):

Specification	Detail
Intrinsic accuracy:	±5.0% ±3 digits
Resolution:	0.1 mA
EN61557 Range:	0.5 mA – 199 A
Max service error:	±10% ±2 digits

Specifications

19.1.10. mV Sensor input (NOT MFT1711 or MFT1721)

Specification	Detail
Including temperature (third party module)	±1.0% ±2 digits
Range	0.0 mV to ±199.9 mV dc
Resolution	0.1 mV

19.1.11. Internal memory (Not MFT1711 or MFT1721)

Specification	Detail
Capacity	1000 results
Bluetooth® communication	

19.1.12. Power consumption:

Specification	Detail
Nominal minimum:	60 mA (Voltage range with no input voltage)
Nominal maximum:	350 mA (Active Insulation test set to 1000 V / 1 MΩ)
Range:	-20 °C to +55 °C

19.1.13. Temperature (via 3rd Party Module)

Specification	Detail
Intrinsic accuracy:	±1.0% ±2 digits
Resolution:	1 °C
Range:	-20 °C to +100 °C

19.2 Environmental Specification.

Specification	Detail
Temperature	
Operational range:	-10 °C to +55 °C
Storage range:	-25 °C to +70 °C
Humidity	90% R.H. at +40 °C max.
Altitude	2000 m to full safety specification.
Weight:	1000 g ±10% including batteries but excluding test leads, accessories and carry case.
Dimensions:	150 mm high x 85 mm wide x 235 mm deep (6 in. x 3.5 in. x 9.5 in.)
IP rating:	IP54
Power Supply.	Battery: Primary 6 x 1,5 V cells IEC LR6 type (AA alkaline,).
Battery:	Rechargeable: 6 x 1.2 V NiMH cells EC HR6. Display shows rechargeable [NiMH] when the battery type is changed in setup option (Section 10).
Safety / EMC.	EMC In accordance with IEC61326 edition 2.
Locations:	Class B locations.
Safety in accordance with BS EN 61010 -1 2010 + 61010 -30:2010	
Installation Category: 600 V CAT III / 300 V CAT IV. (Max Phase to Phase 550 V)	
In addition switch probe and test leads are designed to meet IEC 1010-031:2008, Double insulated to Installation Category III, 300 V phase to earth, 500 V phase to phase.	

20. Accessories

Item	Part Number
Electric vehicle charge-point adaptor	1012-732
Switched probe SP5	1002-774
Neck strap - Megger embroidered	2001-509
3 Wire lead set with prods and clips	1001-991
Mains plug test lead (BS1363)	6220-810
AC battery charger	1002-736
Large soft pouch with extra storage	1007-463
Fused 10 A test lead set (red/blue/green) with prods and clips	1001-975
XTL30 Extension Test Lead 30 m	2007-998
XTL50 Extension Test Lead 50 m	2207-997
Cigar lighter adapter for battery charging.	6280-332
Switched Probe SP5 (silicone)	1001-687
MCC1010 Current measuring clamp	1010-516
MVC1010 Voltage inducing clamp, calibration	1010-518 check pcb (for stakeless test) and lead
Electrode kit	1001-810
Test and carry pouch	1006-408
3 Pole Earth Test Kit	6210-160
ETK30 (3 Pole Earth Test Kit)	1010-176
SIA45 SOCKET I/FACE ADAP SCHUKO	1007-158

21. Repair and Warranty

The instrument contains static sensitive devices, and care must be taken in handling the printed circuit board. If an instrument's protection has been impaired it should not be used, but sent for repair by suitably trained and qualified personnel. The protection is likely to be impaired if for example, it shows visible damage, fails to perform the intended measurements, has been subjected to prolonged storage under unfavourable conditions, or has been subjected to severe transport stresses.

NEW INSTRUMENTS ARE GUARANTEED FOR 1 YEAR FROM THE DATE OF PURCHASE BY THE USER.

NOTE : Any unauthorised prior repair or adjustment will automatically invalidate the Warranty.

21.1 Calibration, repair and spare parts

For service requirements for Megger Instruments contact:

Megger Limited
Archcliffe Road
Dover
Kent CT17 9EN
England.
Tel: +44 (0) 1304 502 243
Fax: +44 (0) 1304 207 342

Megger operate fully traceable calibration and repair facilities, ensuring your instrument continues to provide the high standard of performance and workmanship you expect. These facilities are complemented by a worldwide network of approved repair and calibration companies to offer excellent in-service care for your Megger products.

Returning your product to Megger - UK and USA service centres

1. When an instrument requires recalibration, or in the event of a repair being necessary, a Returns Authorisation (RA) number must first be obtained from one of the addresses shown above. You will be asked to provide the following information to enable the Service Department to prepare in advance for receipt of your instrument, and to provide the best possible service to you.
 - Model, e.g. MFT1845+
 - Serial number, to be found on the underside of the case or on the calibration certificate.
 - Reason for return, e.g. calibration required, or repair.
 - Details of the fault if the instrument is to be repaired.
2. Make a note of the RA number. A returns label can be emailed or faxed to you if you wish.
3. Pack the instrument carefully to prevent damage in transit. **Remove the battery cells before packing.**
4. Ensure the returns label is attached, or that the RA number is clearly marked on the outside of the package and on any correspondence, before sending the instrument, freight paid, to Megger. Copies of the original purchase invoice and packing note should be sent simultaneously by airmail to expedite clearance through customs. In the case of instruments requiring repair outside the warranty period, an immediate quotation can be provided when obtaining the RA number.
5. You may track the progress of your return on line at www.megger.com

21.2 Approved Service Centres

A list of Approved Service Centres may be obtained from the UK address above, or from Megger's website at www.megger.com/support

Local Sales office

Megger Limited
Archcliffe Road
Dover
Kent
CT17 9EN
ENGLAND
T. +44 (0)1 304 502101
F. +44 (0)1 304 207342

Manufacturing sites

Megger Limited
Archcliffe Road
Dover
Kent
CT17 9EN
ENGLAND
T. +44 (0)1 304 502101
F. +44 (0)1 304 207342

Megger GmbH
Weststraße 59
52074 Aachen
T. +49 (0) 241 91380 500
E. info@megger.de

Megger USA - Valley Forge
400 Opportunity Way
Phoenixville, PA 19460
USA
T. +1 610 676 8500
F. +1 610 676 8610

Megger USA - Dallas
4545 West Davis Street
Dallas TX 75237
USA
T. 800 723 2861 (USA only)
T. +1 214 333 3201
F. +1 214 331 7399
E. USsales@megger.com

Megger AB
Rinkebyvägen 19, Box 724,
SE-182 17
DANDERYD
T. +46 08 510 195 00
E. seinfo@megger.com

Megger USA - Fort Collins
4812 McMurry Avenue
Suite 100
Fort Collins CO 80525
USA
T. +1 970 282 1200

This instrument is manufactured in the United Kingdom.

The company reserves the right to change the specification or design without prior notice.

Megger is a registered trademark

The Bluetooth[®] word mark and logos are registered trademarks owned by Bluetooth SIG, Inc and is used under licence.