

# Megger<sup>®</sup>



## **DLRO2 and DLRO2X**

**Ducter™ Low Resistance Ohmmeter 2 A**

*User Guide*

**This document is copyright of:**

Megger Limited, Archcliffe Road, Dover, Kent CT17 9EN. ENGLAND  
T +44 (0)1304 502101 F +44 (0)1304 207342 [www.megger.com](http://www.megger.com)

Megger Ltd reserves the right to alter the specification of its products from time to time without notice. Although every effort is made to ensure the accuracy of the information contained within this document it is not warranted or represented by Megger Ltd. to be a complete and up-to-date description.

For Patent information about this instrument refer to the following web site:

**[megger.com/patents](http://megger.com/patents)**

This manual supersedes all previous issues of this manual. Please ensure that you are using the most recent issue of this document. Destroy any copies that are of an older issue.

## **Declaration of Conformity**

Hereby, Megger Instruments Limited declares that radio equipment manufactured by Megger Instruments Limited described in this user guide is in compliance with Directive 2014/53/EU. Other equipment manufactured by Megger Instruments Limited described in this user guide is in compliance with Directives 2014/30/EU and 2014/35/EU where they apply.

The full text of Megger Instruments EU declarations of conformity are available at the following internet address:

**[megger.com/eu-dofc](http://megger.com/eu-dofc)**

# Contents

<b>1. Introduction</b>	<b>7</b>
1.1 Product Description	7
1.2 Features	7
1.3 Difference Meter	7
1.4 Applications	8
1.5 Company web site	9
<b>2. Safety Warnings</b>	<b>10</b>
2.1 Warnings, Cautions and Notes	10
2.1.1 Warnings	10
2.1.2 Cautions	10
2.1.3 Notes	10
2.2 Safety warnings	10
2.3 Test lead safety warnings:	11
2.4 Installation category definitions:	11
2.5 Safety, Hazard and Warning Symbols on the Instrument	12
2.5.1 Warning Icons	12
<b>3. Instrument Controls</b>	<b>13</b>
3.1 Instrument Layout DLRO2 and DLRO2X	13
3.2 Instrument Rotary Controls DLRO2	14
3.3 Instrument Rotary Controls DLRO2X	14
3.4 Instrument Display	15
3.5 Leads, power and USB connections	16
3.6 The Difference Meter	17
3.7 Difference Meter example of operation	17
<b>4. Setting up the DLRO2 and DLRO2X</b>	<b>19</b>
4.1 Warnings and exception conditions	19
4.2 Power	19
4.2.1 First use	19
4.2.2 Turn the instrument on and off	19
4.2.3 Battery options	19
4.2.4 Setting Date and Time (DLRO2X)	19
4.2.5 Setting test limits (DLRO2X)	20
4.2.6 Test limit warning (DLRO2X)	21
<b>5. Data storage (DLRO2X only)</b>	<b>22</b>
5.1 Create folder for test results	22
5.2 Save test results	23
5.3 Auto Save test results	23
5.4 Save test results to USB stick	24
5.5 Review Asset results	25

5.6	Testing with CertSuite Asset via Bluetooth®.....	26
5.7	Creating a CertSuite Asset account .....	26
5.8	Sending test results to CertSuite Asset.....	26
<b>6.</b>	<b>Tests: Inductive mode .....</b>	<b>27</b>
6.1	Manual stop.....	27
6.1.1	First test.....	27
	Second test.....	27
6.2	Auto stop .....	28
6.2.1	First test .....	28
6.2.2	Second test.....	29
<b>7.</b>	<b>Tests: Resistance mode.....</b>	<b>30</b>
7.1	Auto-start, bidirectional / unidirectional resistance mode .....	30
7.1.1	Post auto-start, unidirectional test:.....	31
7.1.2	Post auto-start, bidirectional test: .....	31
7.2	Manual, bidirectional / unidirectional resistance mode.....	32
7.2.1	For a unidirectional test:.....	33
7.2.2	For a bidirectional test:.....	33
7.2.3	After the test:.....	33
<b>8.</b>	<b>Tests: Long leads mode .....</b>	<b>34</b>
8.1	Long leads mode - auto and manual start.....	34
8.1.1	For manual mode .....	35
8.1.2	For auto mode .....	35
<b>9.</b>	<b>Tests: Noise rejection mode (DLRO2X).....</b>	<b>37</b>
9.1	Confidence Meter™.....	37
<b>10.</b>	<b>Error and Warning Conditions.....</b>	<b>39</b>
10.1	Error code categorisation.....	39
10.2	On screen error messages .....	39
10.2.1	Error screen A .....	39
10.2.2	Error screen B.....	39
10.2.3	Fuse failure.....	39
<b>11.</b>	<b>Settings .....</b>	<b>40</b>
11.1	General settings.....	40
11.2	Test Limit Pass Colour setting (DLRO2X) .....	41
11.3	Bluetooth settings (DLRO2X).....	42
11.5	Date and Time settings (DLRO2X) .....	42
11.6	Language settings .....	42
11.7	Instrument Information .....	43
11.8	Firmware update .....	43

<b>12. Maintenance</b> .....	<b>44</b>
12.1 General Maintenance.....	44
12.2 Cleaning.....	44
12.3 Battery.....	44
12.3.1 Battery status.....	44
12.3.2 12 V Supply.....	45
12.3.3 Battery Charging.....	45
<b>12.3.4 Battery error screens</b> .....	<b>45</b>
12.4 Battery Replacement.....	46
12.4.1 Replace batteries and remove isolation tab.....	46
12.5 Restore Factory Settings.....	47
<b>13. Specifications</b> .....	<b>48</b>
<b>14. Accessories and Equipment</b> .....	<b>50</b>
14.1 Included Accessories.....	50
14.2 Optional Accessories.....	50
14.3 Download PowerDB.....	51
<b>15. Calibration, Repair and Warranty</b> .....	<b>52</b>
15.1 Returns procedure.....	52
<b>16. Decommissioning</b> .....	<b>53</b>
16.1 WEEE Directive.....	53
16.2 Battery disposal.....	53

# 1. Introduction

This user guide details the operational and functional details of the **Megger** DLRO2 and DLRO2X Ducter Low Resistance Ohmmeter 2 A. Please read this user guide fully before attempting to use the DLRO2 units.

## 1.1 Product Description

The DLRO2 range are tough and truly hand held 2 A low resistance ohmmeters, designed to provide fast, accurate and repeatable measurements even in electrically noisy environments.

The DLRO2 range have been designed for ease of use, they can be operated by non-technical users with minimal training.

DLRO2	DLRO2X
There are three main measurement modes:	There are four main measurement modes:
<ul style="list-style-type: none"> <li>■ Normal resistance (<math>\mu\Omega</math>)</li> </ul>	<ul style="list-style-type: none"> <li>■ Normal resistance (<math>\mu\Omega</math>)</li> </ul>
<ul style="list-style-type: none"> <li>■ Fast / long test lead (m<math>\Omega</math>)</li> </ul>	<ul style="list-style-type: none"> <li>■ Fast / long test lead (m<math>\Omega</math>)</li> </ul>
<ul style="list-style-type: none"> <li>■ Inductive resistance (<math>\mu\Omega</math>)</li> </ul>	<ul style="list-style-type: none"> <li>■ Inductive resistance (<math>\mu\Omega</math>)</li> </ul>
	<ul style="list-style-type: none"> <li>■ Noise rejection mode (m<math>\Omega</math>)</li> </ul>

The DLRO2 units are supplied with six HR6 rechargeable NiMH cells which can be charged in the instrument using the supplied external power supply. Non-rechargeable Alkaline AA cells can also be used.

For personal safety and to get the maximum benefit from this instrument, make sure that the safety warnings and instructions are read and understood before the instrument is used. *Refer to 2. Safety Warnings on page 10*

**NOTE :** This user guide includes instructions for all DLRO2 variants. Some facilities may not be available on your model of this equipment.

## 1.2 Features

- Noise rejection mode (DLRO2X only). *Refer to 9. Tests: Noise rejection mode (DLRO2X) on page 38*
- Data and results storage option (DLRO2X only). *Refer to 5. Data storage (DLRO2X only) on page 22*
- 'Difference Meter' for quick comparison of results. *Refer to 3.6 The Difference Meter on page 17*
- Rotary dial test function selection.
- Unidirectional or bidirectional test options on normal resistance test mode.
- Secondary display field showing either forward and reverse measurement results or previous two test results, allowing three test results to be on display at any time for easy comparison.
- Current reversal capability to cancel standing EMF.
- Noisy connection warning, showing when electrical noise or noise from poor clip / probe connections is present.
- Test currents selectable from 1 mA to 2 A
- Capable of 500 measurements from a single charge.
- Supplied with compact CAT III 600 V / CAT IV 300 V rated kelvin clip test leads.

## 1.3 Difference Meter

The Difference Meter allows repetitive measurements to be easily compared with an initial reference measurement. The Difference Meter translates percentage difference to a needle / pointer movement making it easy to see changes in value.

A new reference measurement can be set at any time at the push of a button.

*Refer to 3.6 The Difference Meter on page 17*

### 1.4 Applications

The DLRO2 range measures low resistance values in applications ranging from railways and aircraft to resistance of components in industry. Any metallic joint can be measured but users must be aware of measurement limitations depending on application. For example, if a cable manufacturer plans to make resistive measurements on a thin wire, a low test current should be selected to prevent heating the wire thereby changing its resistance.

This instrument is suited to measuring thick conductors, bonds and quality of welding.

Measurements on electric motors and generators will be inductive and require the user to understand the inductive mode and charging process before a correct result is achieved.

Electromagnetic noise induced into the leads can interfere with a reading. A noise icon alerts the user, but does not prevent a measurement.

The DLRO2X features a noise rejection mode that incorporates the Confidence Meter™ (*Refer to 9. Tests: Noise rejection mode (DLRO2X) on page 38*). This makes the DLRO2X ideal for testing in high noise applications such as wind turbines, switch yards, and heavy industrial locations.

When dissimilar metals are joined a galvanic effect is created. Users should select a bidirectional mode to make sure this effect is cancelled. The instrument measures with current flowing in both directions and averages the result.

- Aviation – Lightning protection testing measuring mΩ resistance between receptors. Wing tip to wing tip etc., using long test leads. Optional long cable reel test leads are available, can be used for assembly of components, interconnection of equipment, repair and maintenance.
- Wind turbines – Lightning protection, measuring mΩ resistance between wing tip to ground connection at base using long test leads. Optional long cable reel test leads are available.
- Rail – Tram and Underground - rolling stock and infrastructure, track high current joints, signalling systems.
- Marine - Power wiring systems, protection systems, ship to shore bonding, cathode protection system testing. Cable laying applications.
- Oil and gas pipelines - Bonding between welded joints, grounding systems.
- Automotive and EV - Battery connections, weld quality, quality of crimped connections, assembly robot welding cables.
- Cable manufacturers - Quality control, cable length.
- Component manufacturers - Quality control.
- Space exploration and engineering - structural metal to metal, ground network metal to metal, carbon fibre to metal, carbon fibre to carbon fibre.
- Data Centres - During electrical installation of main panel, generator and UPS systems. Verification of protective device contact resistance, busbar parallel feeds, busbar lapped joints, optimum resistance over torque and cable lug to busbar connections. During maintenance using trending data for all aspects of the above, verification after repair.
- Medical hand held opportunity - earthing and bonding systems for protection against microshock and macroshock.
- Panel / Switchgear Manufacturers - End of production line testing, site commissioning, maintenance and fault finding.
- Robotics - Wiring systems and connections which are subject to stress / movement / vibration, bonding of component parts to minimise static, grounding of machine, welding leads of robot spot welder.
- Electrical infrastructure - Cable resistance from one end, cable length, identification of parallel supplies while connected, cable to lug to connection fault finding, checking assembled connections main supply cables and panels, switch gear and protective devices, ups and changeover panels, interlinking busbars, interlinking cables, distribution and PDU boards, lightning protection systems, final circuits.



## 1.5 Company web site

Occasionally an information bulletin may be issued via the **Megger** web site. This may concern new accessories, new usage instructions or a software update. Please occasionally check on the **Megger** web site for anything applicable to your **Megger** instruments.

**[www.megger.com](http://www.megger.com)**

## 2. Safety Warnings

The safety instructions given in this document are indicative of safe practice and are not to be considered exhaustive. Additionally, they are not intended to replace local safety procedures in the region where the instrument is used. If the equipment is used in a manner not specified by the manufacturer, the protection provided by the equipment may be impaired. There are no user replaceable parts within the DLRO2.

### 2.1 Warnings, Cautions and Notes

This user guide follows the internationally recognized definition of warnings, cautions and notes. These instructions must be adhered to at all times.

#### 2.1.1 Warnings

Warnings alert the reader to hazardous situations where injury to personnel can occur. They are set in red type to make them stand out. They are placed before the item to which they relate and repeated at each applicable occasion.

#### 2.1.2 Cautions

Cautions alert the reader to situations where equipment damage may result if a process is not followed properly. They are set in bold type. They are placed before the item to which they relate and repeated at each applicable occasion.

#### 2.1.3 Notes

Notes give additional important information that will help the reader. They are not used when a Warning or Caution is applicable. They are not safety related and may be placed either before or after the associated text as required.

### 2.2 Safety warnings

These safety warnings must be read and understood before the instrument is used. Retain for future reference.

**WARNING : This instrument must be operated only by suitably trained and competent people. Protection provided by the instrument may be impaired if it is not used in a manner specified by the manufacturer.**

- Local Health and Safety Legislation requires users of this equipment and their employers to carry out valid risk assessments of all electrical work to identify potential sources of electrical danger and risk of electrical injury such as inadvertent short circuits. Where the assessments show that the risk is significant the use of fused test leads may be appropriate.
- If battery power is lost during the test, then the user will no longer be warned that the load is being discharged. The user must check by independent means that the load is discharged before breaking connection.
- Disconnect all test leads and switch the instrument OFF before opening the battery cover. Covers must be in place before reconnecting the test leads.
- Ensure every cell in the battery compartment is of identical type. Never mix rechargeable and non-chargeable cells.
- This product is not intrinsically safe. Do not use it in an explosive atmosphere.
- Protection provided by the instrument may be impaired if it is not used in a manner specified by the manufacturer.
- The voltage warning function will operate only if the instrument is switched on and working correctly. In the absence of an indication do not assume that there are no hazardous voltages.
- The voltage indicator and current discharge features must be regarded as additional safety features and MUST not substitute the normal safe working practice which MUST be followed.
- The instrument must not be used if any part of it is damaged or if the terminal shutter is missing.

- The circuit under test must be switched off, de-energized, securely isolated and proved dead before test connections are made.
- Circuit connections, exposed conductive parts and other metalwork of an installation or equipment under test must not be touched during testing.
- Only **Megger** approved test leads with right-angled instrument connectors must be used with this instrument. Test leads must be at least 1 m in length and provide a total loop impedance  $\geq 26 \text{ m}\Omega$ .
- When inductive loads are measured it is essential that the current carrying leads are securely clamped to the item being tested and that they are not removed before any stored charge has been discharged at the end of the test. Failure to comply with these instructions might result in an arc being produced which might be dangerous for the instrument and the operator.
- All test leads, probes and crocodile clips must be in good order, clean and with no broken or cracked insulation. Verify the integrity of the test leads before use.
- The safe maximum limit of a measurement connection is that of the lowest rated component in the measurement circuit formed by the instrument, test leads and any accessories.
- Ensure that hands remain behind finger guards of probes and clips.

### 2.3 Test lead safety warnings:

- Test leads, including crocodile clips, must be in good condition, clean, dry, and free of broken or cracked insulation. The lead set or its components must not be used if any part of it is damaged.
- The safe maximum limit of a measurement connection is that of the lowest rated component in the measurement circuit formed by the instrument, test leads and any accessories.

### 2.4 Installation category definitions:

**CAT IV** – Measurement category IV: Equipment connected between the origin of the low-voltage mains supply and distribution panel.







**CAT III** – Measurement category III: Equipment connected between the distribution panel and electrical outlets.

**CAT II** – Measurement category II: Equipment connected between the electrical outlets and user's equipment.

Measurement equipment may be safely connected to circuits at the marked rating or lower. The connection rating is that of the lowest rated component in the measurement circuit.



## 2.5 Safety, Hazard and Warning Symbols on the Instrument

This paragraph details the various safety and hazard icons on the instrument's outer case.

Icon	Description
	Warning: High Voltage, risk of electric shock
	Caution: Refer to User Guide.
	Equipment complies with current EU directives.
	Equipment complies with current UKCA directives.
	Equipment complies with current 'C tick' requirements.
	Do not dispose of in the normal waste stream.
	Equipment protected throughout by double insulation.
IP54	IP rating

### 2.5.1 Warning Icons

This paragraph details the warning icons that can show on the display.

Icon	Warning	Description
	External Voltage Warning	If an external voltage is applied between the terminals and the instrument is set to ON, the external voltage warning will flash on the display. This is a warning that the item under test is live, it might be dangerous so testing is disabled. The external voltage warning message will flash if more than 5 V potential difference is applied between the voltage terminals and the current terminals. This warning will not show if all terminals are at the same external voltage.  NOTE: The warning will not operate if the instrument is set to OFF.
	Internal Error Warning	Internal Error Warning. To clear the error, switch the instrument OFF and then back ON. Contact <b>Megger</b> if this does not clear the error.
	Read the User Guide	Refer to the user guide if this message shows.

### 3. Instrument Controls

#### 3.1 Instrument Layout DLRO2 and DLRO2X

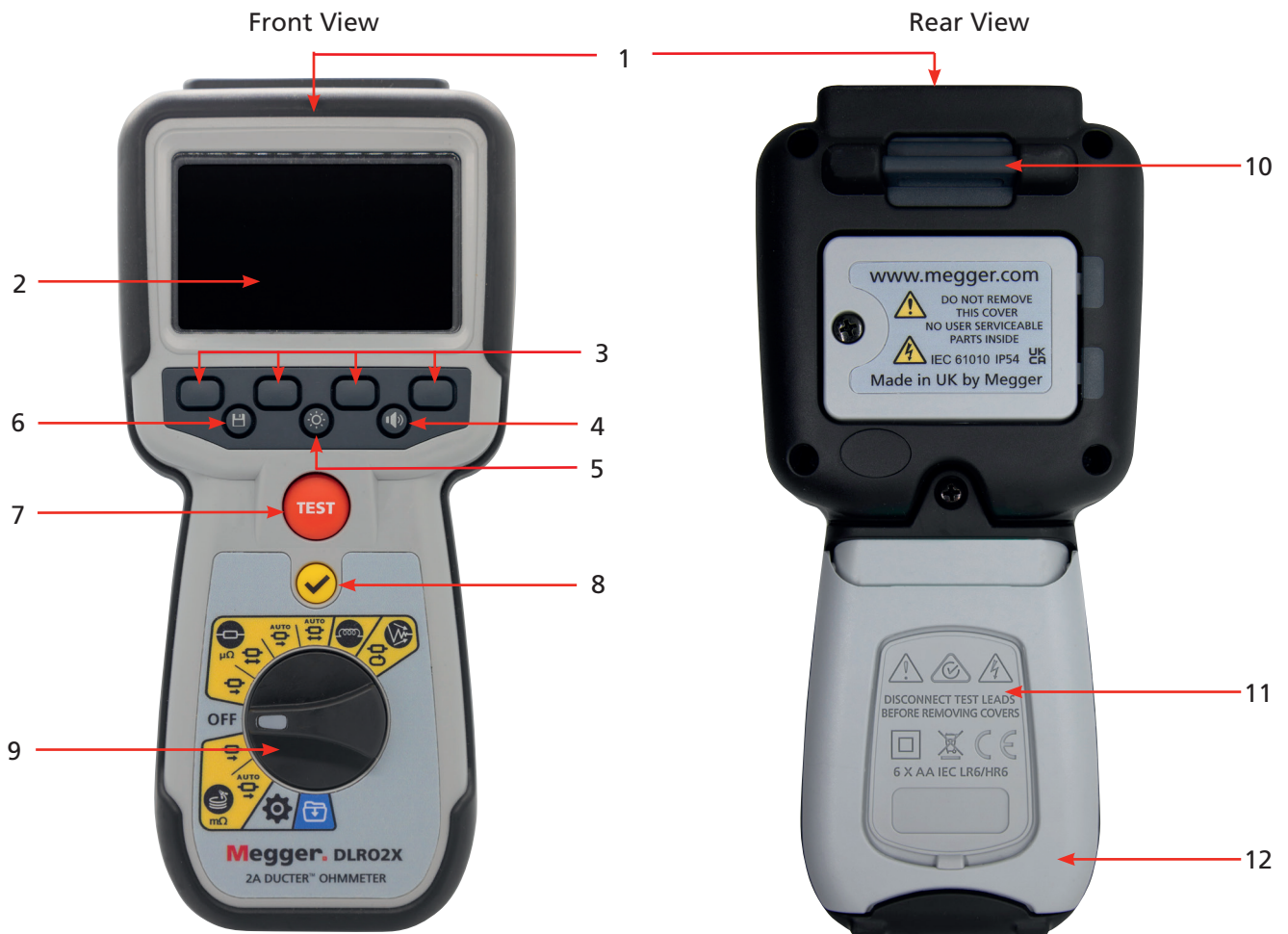

Item	Description	Item	Description
1	External electrical connections. <i>Refer to 3.5 Leads, power and USB connections on page 16</i>	10	Attachment point for strap
2	Display	11	Battery cover
3	Soft keys (multifunction)	12	Stand
4	Test Limits On or Off (DLRO2X)		
5	Back-light control		
6	Save results / Auto Save On (DLRO2X)		
7	Test		
8	TICK button		
9	Rotary selection switch		

### 3.2 Instrument Rotary Controls DLRO2

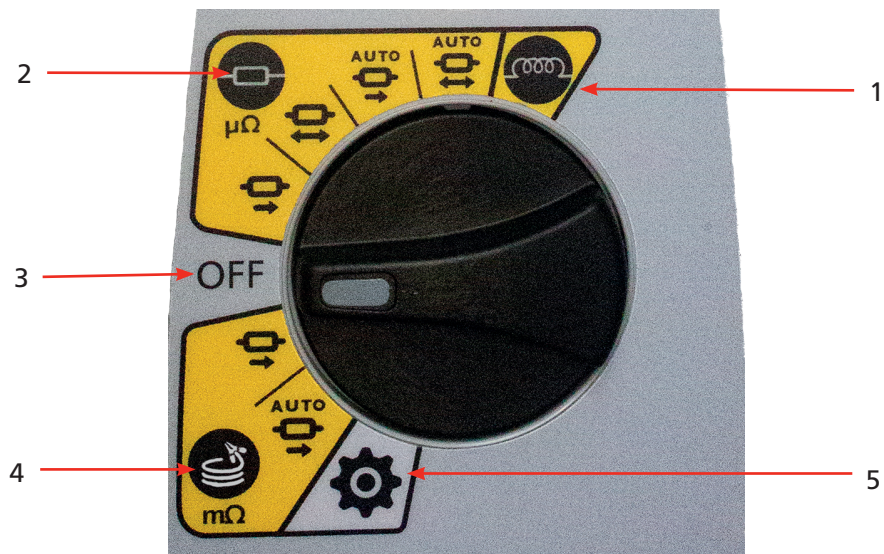

Item	Description	Item	Description
<b>Rotary switch positions</b>			
1	Inductive mode	4	Long leads mode
2	Normal resistance mode	5	Settings mode (grey)
3	Off position		

### 3.3 Instrument Rotary Controls DLRO2X

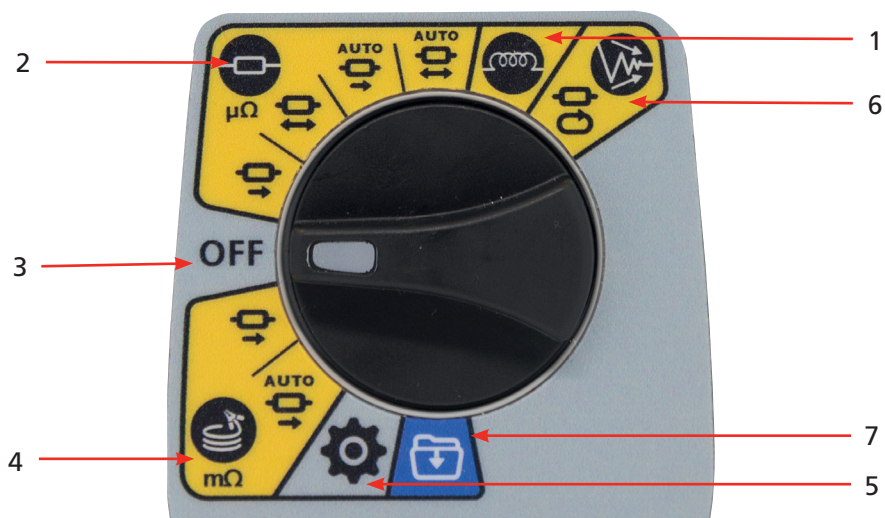

Item	Description	Item	Description
<b>Rotary switch positions</b>			
1	Inductive mode	5	Settings mode (grey)
2	Normal resistance mode	6	Noise rejection mode
3	Off position	7	Data storage mode (blue)
4	Long leads mode		

### 3.4 Instrument Display

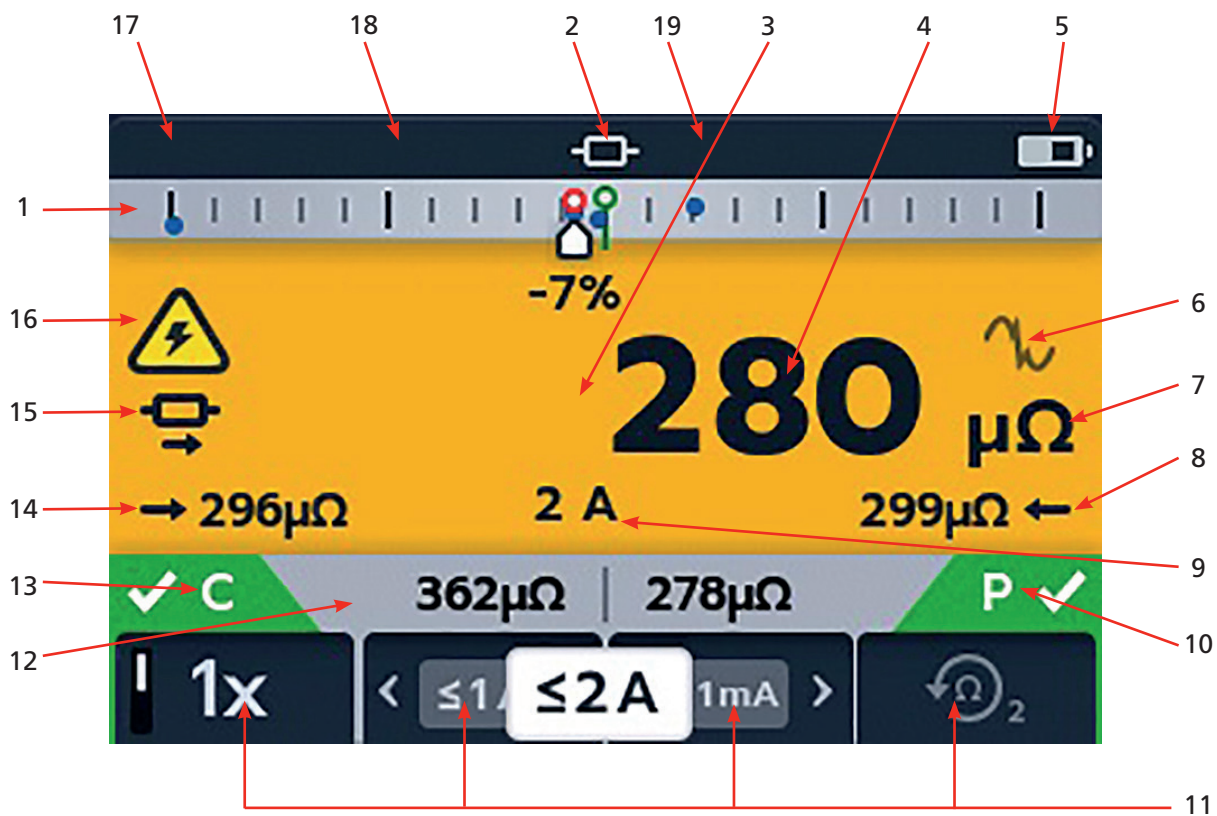

Item	Description	Item	Description
1	Difference Meter. (Refer to 3.6 The Difference Meter on page 17) Confidence Meter™ on DLRO2X (Refer to 9. Tests: Noise rejection mode (DLRO2X) on page 38)	11	Soft keys functions (dependant on rotary selection switch position)
2	Operating mode	12	Secondary field
3	Primary field	13	C continuity indicator
4	Latest result	14	Forward measurement result
5	Battery condition indicator	15	Unidirectional or bidirectional selection
6	Noise indicator	16	Inductive charge warning
7	Units of measure (for latest result)	17	Time (DLRO2X only)
8	Reverse measurement result	18	Auto Save activated (DLRO2X only)
9	Selected test current	19	Test Limits warning indicator (DLRO2X only)
10	P continuity indicator		

## Instrument Controls

### Confidence Meter™

When High noise mode is selected on the DLRO2X the Difference Meter becomes the Confidence Meter™. Refer to 9. Tests: Noise rejection mode (DLRO2X) on page 38

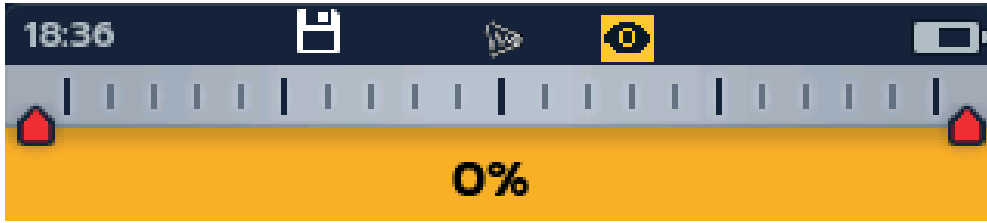

### 3.5 Leads, power and USB connections

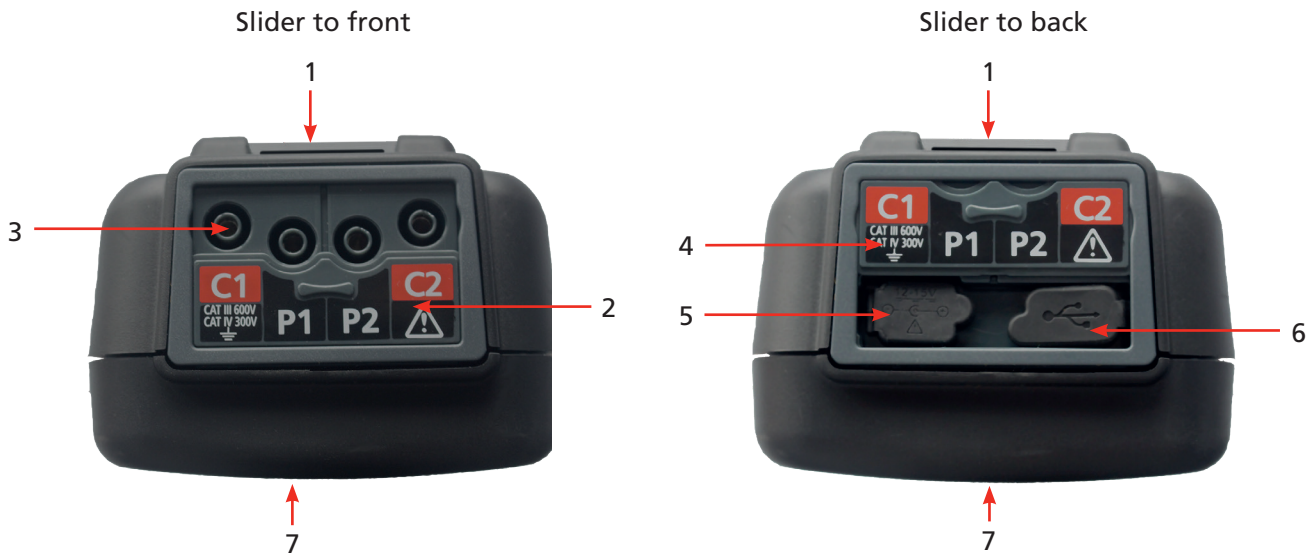

Item	Description	Item	Description
1	Rear attachment point for strap	4	Slider in rear position
2	Slider in front position	5	Battery charger connection
3	Connections: C1, P1, P2, C2	6	USB port (firmware updates or Data transfer (DLRO2X only) via USB stick)
		7	Front



### 3.6 The Difference Meter

The Difference Meter is a feature on the DLRO2 / DLRO2X that is displayed at the top of the primary screen (marked '1' on the diagram).

The Difference Meter works in inductive and resistive modes only. It can be toggled off and on in the instrument settings, giving space for other characters in the primary field to be displayed in a larger format making them easier to read, if required. Refer to 9.1 General Settings on page 28.

Repetitive measurements can be easily compared with an initial reference measurement. The Difference Meter translates percentage difference to a needle / pointer movement making it very easy to see change. The green marker shows the initial or reference reading. Noisy results are shown with a red marker. Good results are shown with a blue marker. When testing, pressing the TICK button (✓) sets the latest reading as the reference reading and cancels all other readings recorded on display, including those on the Difference Meter and the secondary field.

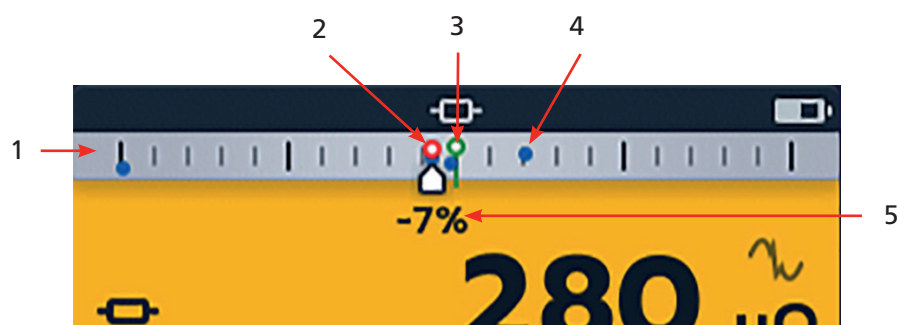

Item	Description		Item	Description	
1	Difference Meter		4	Blue result marker shows that noise is not present. Open circle for latest result / solid circle for previous result	○ ●
2	Red result marker shows that noise is present. Open circle for latest result / solid circle for previous result	○ ●	5	Latest measurement showing percentage difference compared to initial reference measurement	🏠 -7%
3	Reference measurement, green	📍			

**NOTE :** All markers are positioned in chronological order. The most recent is positioned high on the Difference Meter line, the oldest is positioned lowest.

### 3.7 Difference Meter example of operation

This explanation of the Difference Meter is written in reference to resistance mode but the explanation applies equally to inductive mode.

Resistance measurement is selected. The Difference Meter is inactive. Continuity is indicated for C and P leads



## Instrument Controls

First measurement is complete. The Difference Meter is now active. The first measurement is shown as a green ring at the centre of the scale with +0% below.



A second measurement is made, the Difference Meter shows result relative to reference measurement (+30% in this case) showing an increase. Shown as a blue ring

**NOTE :** For each successful measurement the needle leaves a blue marker on the Difference Meter (a red marker if the reading contains noise).

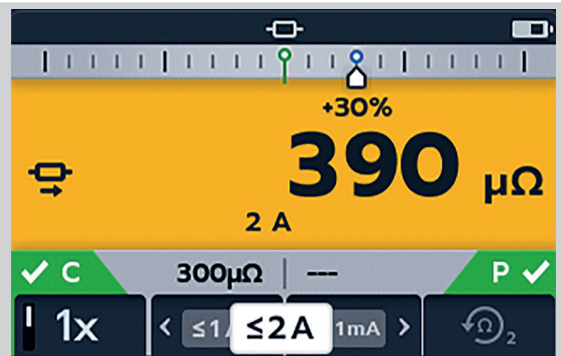

Third measurement is made, the Difference Meter shows it's result relative to the first (>+1000% in this case) showing an increase.

The 1000% difference shows clearly that something isn't right. Check the leads, connections, unit under test, etc.

**NOTE :** The units on the main display have changed from  $\mu\Omega$  to  $m\Omega$  and are now indicated in blue to highlight the change.



Fourth measurement is made, the Difference Meter shows it's result, again relative to the first measurement.

The new reading is -1% showing a possible return to the expected result.

**NOTE :** The units on the main display have changed back to  $\mu\Omega$  and are shown in blue indicating another change.



Fifth measurement is made, the Difference Meter shows it's result, relative to the reference measurement. This reading is now just -1% lower than the reference measurement.

**NOTE :** The units remained unchanged as  $\mu\Omega$  and are shown in black.

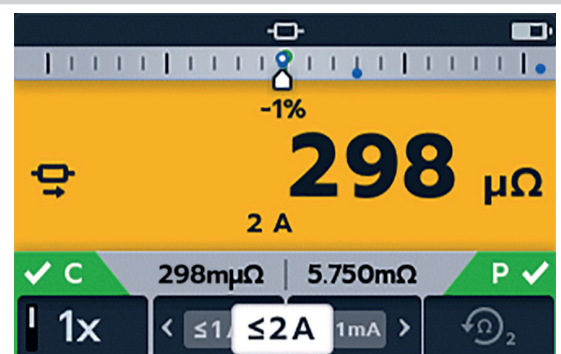

## 4. Setting up the DLRO2 and DLRO2X

Before each use visually inspect all equipment about to be used. Check the instrument is in good condition and there is no visible damage to either the instrument or the test leads. Confirm the instrument case, test leads and connectors are in good condition with no damaged or broken insulation

### 4.1 Warnings and exception conditions

Refer to 10. Error and Warning Conditions on page 40

### 4.2 Power

#### 4.2.1 First use

**NOTE :** Before the DLRO2 can be turned on the battery isolation tab must be removed.

1. Remove the battery cover.
2. Pull the battery isolation tab clear of the batteries.
3. Replace cover.

For further details on accessing the battery panel, Refer to 12.4 Battery Replacement on page 47.

#### 4.2.2 Turn the instrument on and off

1. Turn the instrument ON by rotating the rotary switch to the required operating mode (away from the OFF position).
2. Turn the instrument OFF by rotating the rotary switch to the OFF position.

#### 4.2.3 Battery options

**CAUTION : Do not attempt to recharge alkaline cells, this action is a high potential fire hazard.**

The DLRO2 is powered by Internal batteries,

- These cells may be used:
  - 6 x LR6 1.5 V Alkaline (AA)
  - 6 x IEC HR6 1.2 V NiMH

The DLRO2 is charged using the supplied mains adapter (NiMH cells only), which will work at voltages between 100 V and 240 V AC. Ensure the correct battery type is selected in the setting menu. Charging will only occur if the battery type is set to NiMH. Refer to 11. Settings on page 41.

**WARNING : Charge NiMH cells only between 0 °C and 40 °C ambient temperature.**

#### 4.2.4 Setting Date and Time (DLRO2X)

To set the Date and Time please Refer to 11.4 Date and Time settings (DLRO2X) on page 43

## Setting up the DLRO2 and DLRO2X

### 4.2.5 Setting test limits (DLRO2X)

Switch the rotary switch to the settings mode (Refer to 9.1 General settings on page 28).



1. Use the arrow keys to select the Lower Test Limit and click the TICK button (✓) to select.

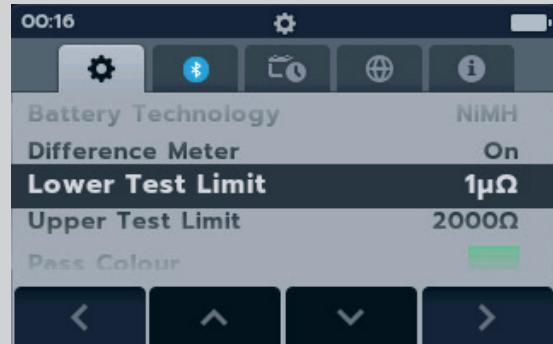

2. Use the soft keys 1 or 4 to move the selector left or right to choose the Units of measurement and the limit required. Use the up and down arrows (soft keys 2 and 3) to select the numbers..

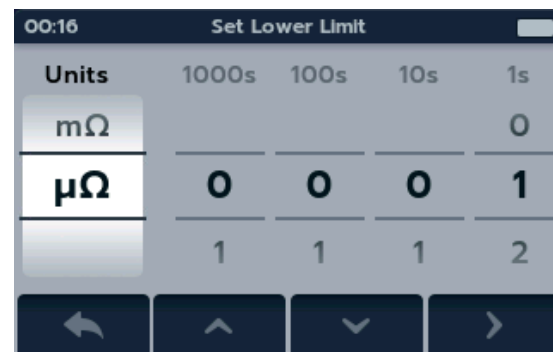

3. When the selection is complete use soft key 4 to click the TICK (✓) and to save your test limit settings.



4. Go back to the main Settings menu and do the same for the Upper Test Limit.



#### 4.2.6 Test limit warning (DLRO2X)

When the test limit is reached a visual and audible warning will appear on the display. This can be set to three settings:

1. Off (shown)
2. Visual warning
3. Visual and audible warning



When the visual warning is activated an eye symbol  will appear at the top of the display.



When the visual and audible warning is activated this symbol  will appear at the top of the display.



## 5. Data storage (DLRO2X only)

The DLRO2X can save results to a folder which can then be transferred onto a USB data stick to transfer to your PC.

### 5.1 Create folder for test results

1. Turn rotary switch to select the Data Storage mode.



The Default Asset ID can be used to save results or a new one can be created.

2. To create a new Asset ID, click the + key.

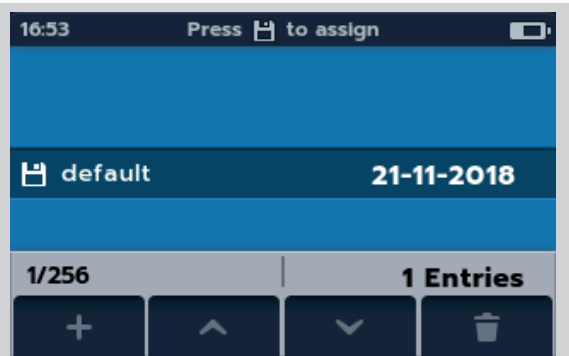

3. Use the soft keys to move the cursor around the keyboard and click the TICK button (✓) to select.



4. Press SAVE (SAVE) and the new Asset ID will appear on the Data storage home page. Use the up and down arrows to select the Asset folder that you wish to save your results in. The Asset with the SAVE icon (SAVE) next to it will be used for saving results. (Refer to 5.3 Auto Save test results on page 23)

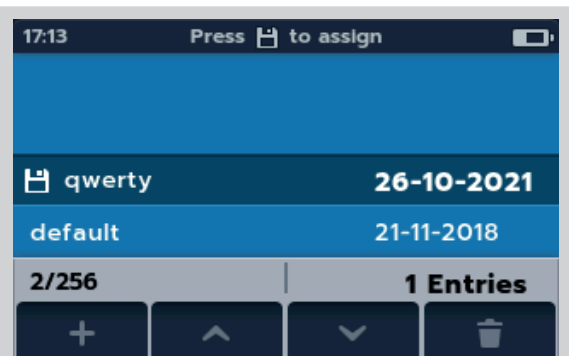

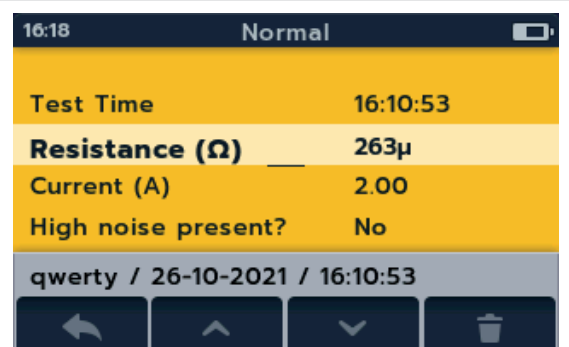

5. To view the results, click the TICK button (✓).

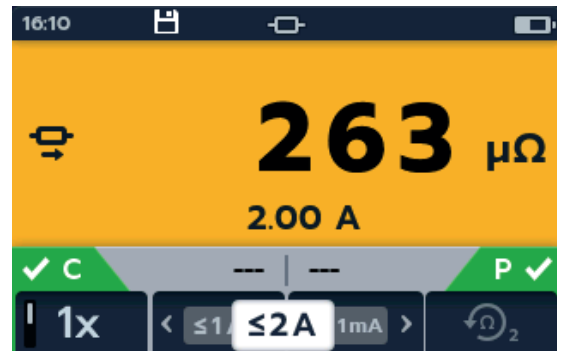

## 5.2 Save test results

1. To save your test results when the test has completed press the SAVE button .



2. On the Data storage page use the soft keys to select the Asset ID that you require the results to be added to and click the TICK button ()

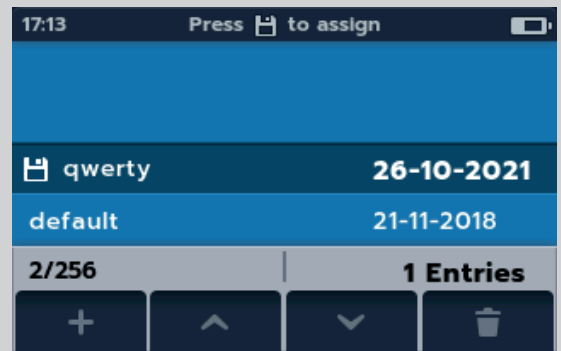

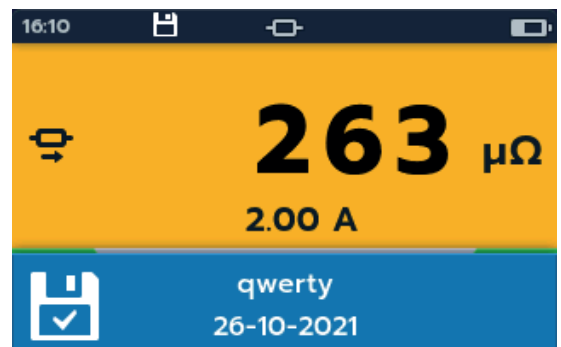

3. You will then see confirmation that the results have been saved.

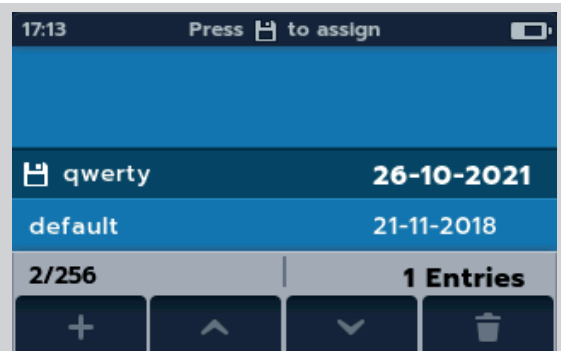

## 5.3 Auto Save test results

1. On the Data storage page use the soft keys to select the Asset ID that the Auto Saved results will be added to. The SAVE icon () will appear next to the chosen Asset ID.



2. Before starting the test, press the SAVE () button. The Auto Save icon will appear at the top of the screen.



## Data storage (DLRO2X only)

3. Run the test and the results will automatically be saved to the previously selected Asset ID.



4. When the results are saved in the Asset ID a pop up will appear with the Asset ID name.

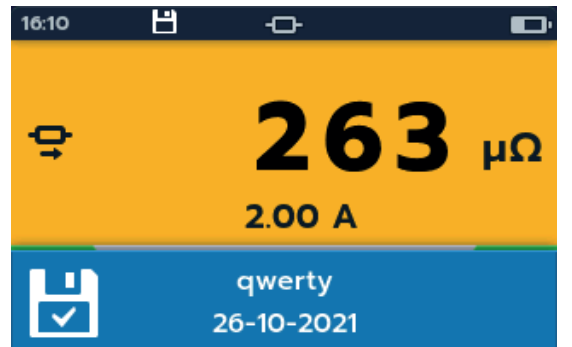

5. To view the results, turn the rotary switch to Data Storage mode, select the Asset ID and click the TICK button (👉) until the desired results are on screen.

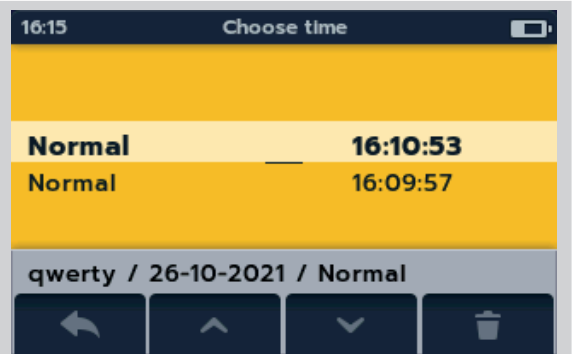

### 5.4 Save test results to USB stick

1. To save your test results to a USB stick you must first insert the USB stick into the USB socket.
2. The Disk icon will appear above soft key 1.
3. Use the soft keys to select the Asset ID that you require to be copied to the USB stick and click soft key 1.



4. Use soft key 2 to select the Asset ID to copy to the USB stick, or click soft key 3 if you want ALL Assets to copy to USB.



5. When the data has copied to the USB stick a message will appear. The USB stick can be removed to transfer the data to your PC.

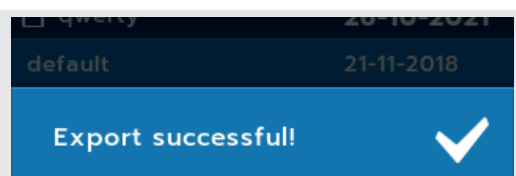



## 5.5 Review Asset results

1. On the Data storage page use the soft keys to select the Asset ID that you want to open and click the TICK button (✓).

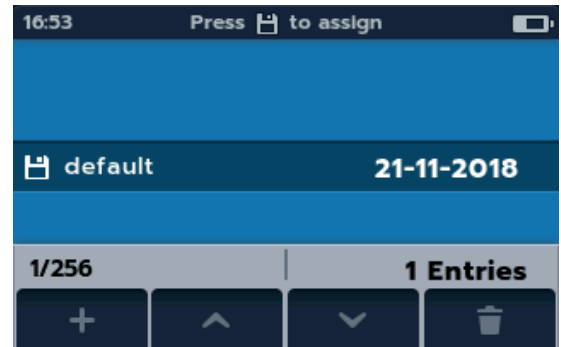

2. Select the date of the test results that you want to review.

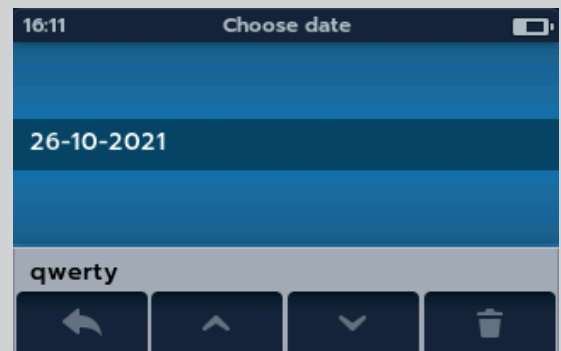

3. Select the type of test from the list.

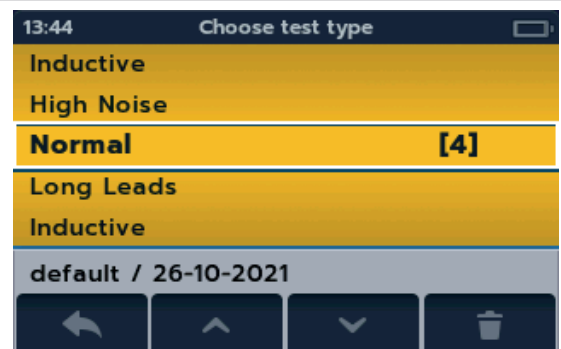

4. Choose the time that the test was taken.



5. The results for that test on the chosen date will appear on screen. Use the soft keys to navigate up and down or delete the results.

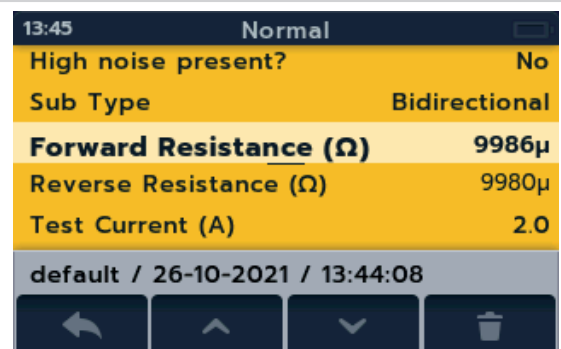

## 5.6 Testing with CertSuite Asset via Bluetooth®

The instrument can be connected to a range of remote devices for receiving the test results and passing them to the cloud-based Megger CertSuite Asset software. They are:

- Android phones and tablets
- Windows laptops and desktops

Each result can be transferred from the instrument to a mobile device running CertSuite™ in a browser, from which they are automatically transferred to the cloud if a network is available, or immediately a mobile network is detected if not available at that time.

Test results on the mobile device are synchronized with the cloud system every 90 seconds to reduce any risk of data loss from the mobile device.

A summary of the installation sequence is:

1. Create an account on the CertSuite™ web site. Refer to 5.7 Creating a CertSuite Asset account on page 26
2. Switch on the Bluetooth® mode on the S1. Refer to 11.3 Bluetooth settings (DLRO2X) on page 43
3. Open the browser on your mobile device or Windows PC and log in to your account using the details from (1) above.
4. Connect CertSuite™ to your DLRO2X from within CertSuite Asset by clicking on Get Data.

Visit **CertSuite.info** to create an account for CertSuite Asset, or scan the QR code below:



**NOTE :** The instrument does NOT need to be connected to a mobile device. The CertSuite™ software should find the instrument if the DLRO2X and mobile device Bluetooth® are active.

## 5.7 Creating a CertSuite Asset account

Before CertSuite Asset can be used an account has to be created. This can be done by going to **www.CertSuite.info** and select the **FREE TRIAL** option. Follow the guidance on the CertSuite™ web site.

Keep a record of your account information and password as you will need this when using CertSuite Asset on mobile devices.

If necessary, any assistance can be accessed through the CertSuite™ (**www.CertSuite.info**) or Megger web sites (**www.megger.com**) and Megger technical support (**uksupport@megger.com**).

## 5.8 Sending test results to CertSuite Asset

Once the instrument and CertSuite Asset are connected, results can be transferred to the mobile device. While the test is being run, the app builds a graph of the test results. It can store client's details, asset details, photos and comments.

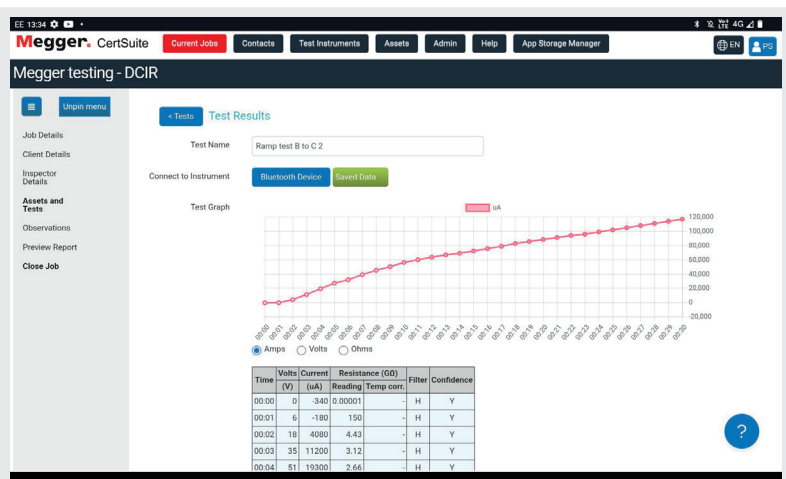

## 6. Tests: Inductive mode

Inductive test mode allows users to measure resistance of an inductive load (i.e. motors, small power transformers, etc.).

**Test current can measure up to 1 A.**

**NOTE :** Pre-charging; before any measurement can be made, the circuit needs to be 'pre-charged'. This is carried out at a low current (1 mA) and is indicated on the display by an animated sequence of chevrons (< << <<< <<<<). The animation will be displayed until the pre-charge phase is complete.

**WARNING :** When inductive loads are measured it is essential that the current carrying leads are securely clamped to the item being tested and that they are not removed before any stored charge has been discharged at the end of the test. Failure to comply with these instructions might result in an arc being produced which might be dangerous for the instrument and the operator.

### 6.1 Manual stop

1. Turn rotary switch to select the inductive mode position.





#### 6.1.1 First test

**NOTE :** To AUTO SAVE results click the SAVE (  ) button now (Refer to 5. Data storage (DLRO2X only) on page 22).

Inductive test screen appears, 'Inductive Mode' shows in secondary field for a short time then disappears.

**NOTE :** Soft key 1 toggles manual / auto stop.

2. Select MANUAL on soft key 1.
3. Connect C1-C2 and P1-P2 to the instrument and the unit under test.

C and P indicators show red background with  for no continuity or green background with  for good continuity. Proceed when both show . The continuity indicators are active during the test and will update if continuity changes.



## Tests: Inductive mode

4. To start the test press the TEST button.

Resistance and current values continually up date on screen. The current starts at 1 mA and can reach a maximum of 1 A if a higher current is required for the resistance being measured.



### End of the test

To stop the test press the TEST button. **NOTE:** The TICK button (✓) will set a new reference value.

**Click SAVE now if you wish to record your results.**

**WARNING : Do not disconnect test leads until discharge is completed.**



During the discharge phase, the buttons and rotary switch will be inactive. While discharging is still in progress a warning symbol (⚡) will flash on the left of the screen and an audible warning buzzer will sound. Do not remove the test leads until discharge is complete and the warning disappears.

### 6.1.2 Second test

1. To start the test press the TEST button.

The animated chevron sequence will be displayed during the pre-charge phase of the measurement, to be replaced by resistance and current values updating as the instrument auto-ranges.



Readings continue to update until a stable measurement is achieved.

2. When the result is stable press the TEST button.

The Difference Meter records the reading.



### End of the test

To stop the test press the TEST button. **NOTE:** The TICK button (✓) will set a new reference value.

**Click SAVE now if you wish to record your results.**

**WARNING : Do not disconnect test leads until discharge is completed.**



During the discharge phase, the buttons and rotary switch will be inactive. While discharging is still in progress a warning symbol (⚡) will flash on the left of the screen and an audible warning buzzer will sound. Do not remove the test leads until discharge is complete and the warning disappears.

**NOTE :** If continuity is lost from either the C or P connection during a test, this screen will be displayed for 3 seconds. The DLRO2 will then return to the start of the test.

**TEST FAILED**  
Continuity lost during test



## 6.2 Auto stop

1. Turn rotary switch to select the inductive mode position.

**NOTE :** To AUTO SAVE results click the SAVE (  ) button now (Refer to 5. Data storage (DLRO2X only) on page 22).



### 6.2.1 First test

Inductive test screen appears, 'Inductive Mode' shows in secondary field for a short time then disappears.



**NOTE :** Soft key 1 toggles MANUAL / AUTO.



2. Select AUTO on soft key 1.



3. Connect C1-C2 and P1-P2 to the instrument and the unit under test.

C and P indicators show red background with  for no continuity or green background with  for good continuity. Proceed when both show . The continuity indicators are active during the test and will update if continuity is lost.

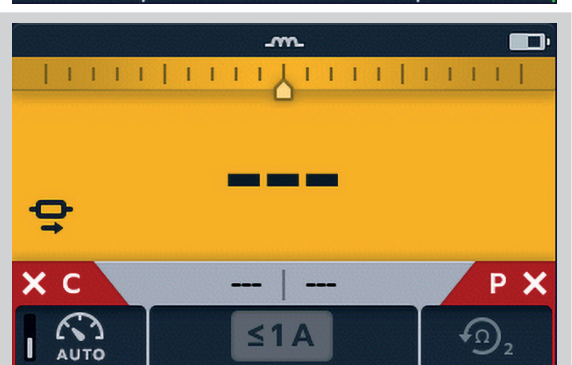

4. To start the test press the TEST button.

During the test results will live update on screen. The test will stop automatically when the instrument determines that the reading has been stable for long enough and is unlikely to change significantly; the user can override the instrument and stop the test at any time by pressing the TEST button.

The Difference Meter is active.

When the test is stopped the displayed result is static.



## Tests: Inductive mode

### End of the test

When the test stops, either automatically or after the user has pressed the TEST button, the instrument will enter the discharge phase.

**Click SAVE now if you wish to record your results.**

**WARNING : Do not disconnect test leads until discharge is completed.**



During the discharge phase, the buttons and rotary switch will be inactive. While discharging is still in progress a warning symbol () will flash on the left of the screen and an audible warning buzzer will sound. Do not remove the test leads until discharge is complete and the warning disappears.

**NOTE :** The TICK button () will set a new reference value.

### 6.2.2 Second test

1. To start the test press the TEST button.

Previous result moves to secondary display. Primary display shows 3 dashes till a new valid reading is received.

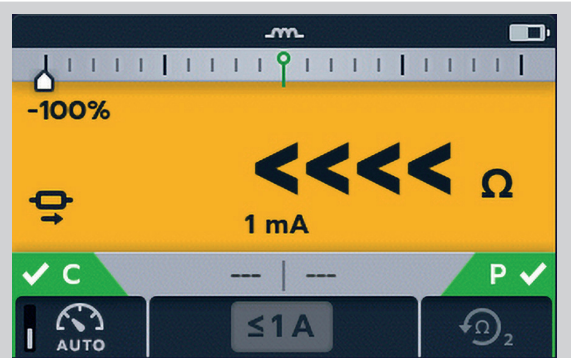

The readings will update until a stable measurement is achieved, at which point the instrument will automatically stop the test. The test can also be stopped at any time by pressing the TEST button

After the test, the Difference Meter records the reading and primary screen will show the result.

**NOTE :** 'Two previous results' in the secondary screen, left is previous result and right is the result before that.

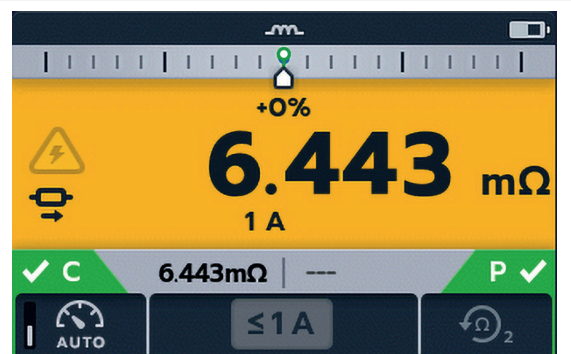

**CAUTION : If the reading is unstable the DLRO may not auto stop. The user will need to manually stop the test.**

When the test stops, either automatically or after the user has pressed the TEST button, the instrument will enter the discharge phase.

**Click SAVE now if you wish to record your results.**

**WARNING : Do not disconnect test leads until discharge is completed.**



During the discharge phase, the buttons and rotary switch will be inactive. While discharging is still in progress a warning symbol () will flash on the left of the screen and an audible warning buzzer will sound. Do not remove the test leads until discharge is complete and the warning disappears.

**NOTE :** The TICK button () will set a new reference value.

## 7. Tests: Resistance mode

Resistance mode measures the resistance of a unit under test in a forward current direction (unidirectional mode) or forward and reverse direction (bidirectional mode). In manual start mode, the test will be carried out when the TEST button is pressed. In auto start mode the DLRO2 will start the test automatically as soon as continuity is detected, however it will not automatically start testing if continuity is established before the test mode is selected.

### 7.1 Auto-start, bidirectional / unidirectional resistance mode

1. Turn rotary switch to select either the auto-start, bidirectional resistance mode position or auto-start, unidirectional resistance mode position.

**NOTE :** To AUTO SAVE results click the SAVE (  ) button now (Refer to 5. Data storage (DLRO2X only) on page 22).

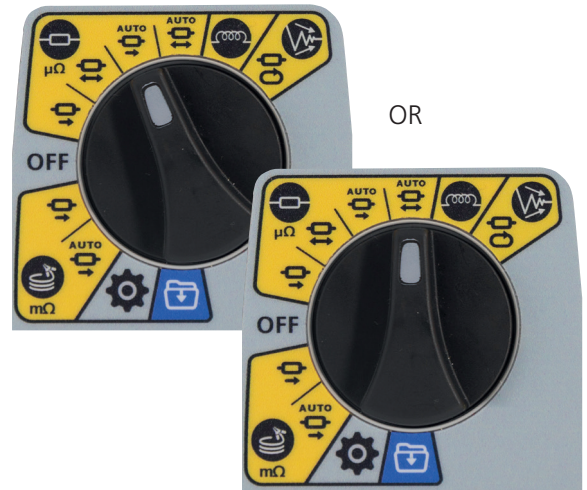



Resistance test screen appears, 'Auto-start, Bidirectional Resistance Mode' or 'Auto-start, Unidirectional Resistance Mode' shows in secondary field for a short time then disappears.

**NOTE :** Soft key 1 toggles continuous / single test.  
Soft keys 2 / 3 cycles through current ratings; default is 2 A, selectable 1 A, 100 mA, 10 mA, 1 mA.  
In bidirectional, soft key 4 toggles between 'Display previous 2 results' and 'Forward and reverse direction'.



2. Select test settings using the soft keys.

3. Connect C1-C2 and P1-P2 to the instrument and the unit under test.

C and P indicators show red background with  for no continuity or green background with  for good continuity.

When continuity is detected on both circuits, the C and P indicators will both be greyed out and the test will start automatically.

If required, to stop the test press the TEST button.



## Tests: Resistance mode

The dashes (or an old result) will flash until a new result is displayed.

During the test, continuity indicators will fade and soft keys will be inactive.

For bidirectional tests, the dashes (or the previous result) and left hand arrow will flash while the instrument performs a reading in the forward direction. When the forward measurement is complete, it is shown next to the left hand arrow, and then the right hand arrow and the dashes (or the previous result) flash to indicate that the test current has been reversed.

For unidirectional tests, the dashes (or the previous result) will flash until a result is ready.

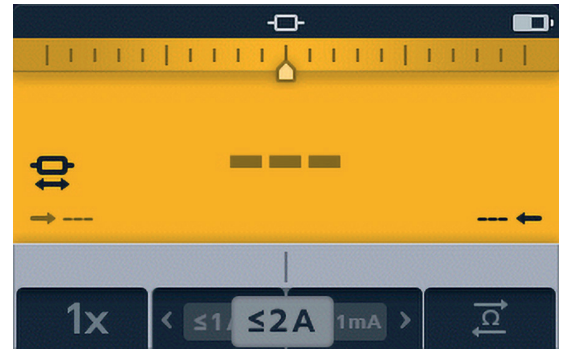

### 7.1.1 Post auto-start, unidirectional test:

After an auto-start, unidirectional test the C and P continuity indicators will be grey if continuity was maintained. This indicates the C or P lead must be disconnected and reconnected to restart the test.

- Note:** Test button will start another test.
- Soft key 1 toggles continuous / single test.
- Soft keys 2 / 3 cycles through current ratings; default is 2 A, selectable 1 A, 100 mA, 10 mA, 1 mA.
- Soft key 4 is inactive.

The TICK button (👉) sets new reference value.



### 7.1.2 Post auto-start, bidirectional test:

After an auto-start, bidirectional test the C and P continuity indicators will be grey. This indicates the C or P lead must be disconnected and reconnected to start the next test.

If an auto-start test is interrupted by pressing the TEST button C and P continuity indicator will turn grey. This indicates the C or P lead must be disconnected and reconnected to restart the test. Alternatively press the TEST button to start another test.



Continuity on C or P has been lost. Re-establish continuity to start a new test.





## 7.2 Manual, bidirectional / unidirectional resistance mode

1. Turn rotary switch to select either the bidirectional resistance mode position or unidirectional resistance mode position.

**NOTE :** To AUTO SAVE results click the SAVE (  ) button now (Refer to 5. Data storage (DLRO2X only) on page 22).

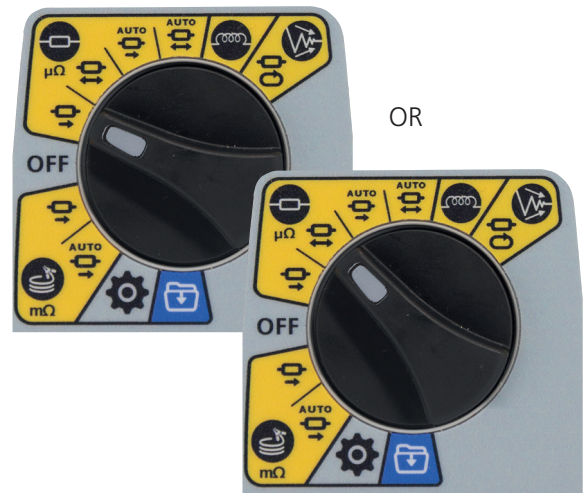

Resistance test screen appears, 'Bidirectional Resistance Mode' or 'Unidirectional Resistance Mode' shows in secondary field for a short time then disappears.



**NOTE :** Soft key 1 toggles continuous / single test.  
Soft keys 2 / 3 cycles through current ratings; default is 2 A, selectable 1 A, 100 mA, 10 mA, 1 mA.  
Soft key 4 is only active in bidirectional resistance mode and toggles between 'Display previous 2 results' / 'Forward and reverse direction'.

In unidirectional resistance mode soft key 4 is inactive and will default to 'Display previous 2 results'.



2. Select test settings using the soft keys.

3. Connect C1-C2 and P1-P2 to the instrument and the unit under test.

C and P indicators show red background with  for no continuity or green background with  for good continuity.



Proceed when both show .

4. To start the test press the TEST button.

If required, to stop the test press the TEST button.



## Tests: Resistance mode

### 7.2.1 For a unidirectional test:

As the test starts, continuity indicators will fade.

Dashes or previous value will flash on the main display until result appears.

On the secondary display dashes or previous results will flash until a new result is ready.

The soft keys will not operate during this test.

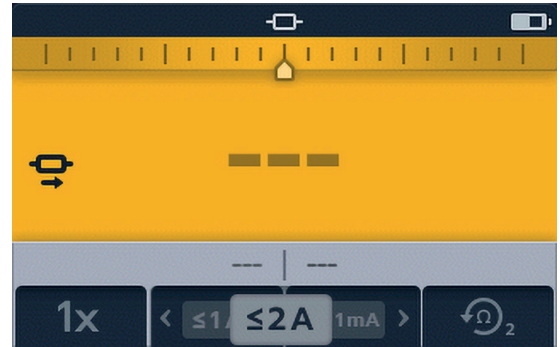

### 7.2.2 For a bidirectional test:

As the test starts, continuity indicators will fade.

The left arrow with dashes will flash first until a result appears, then the right arrow with dashes will flash until a result appears.

Dashes or previous value will flash on the main display until average of the two results appears.

On the secondary display dashes or previous results will flash until a new result is ready.

The soft keys will not operate during this test.

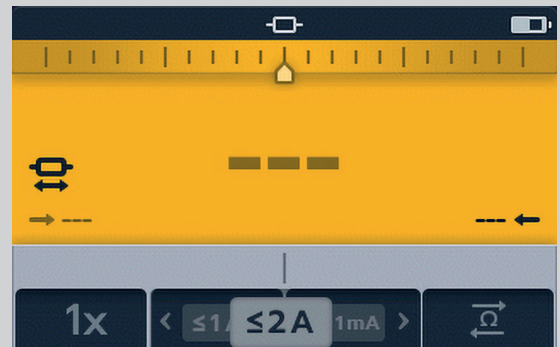

### 7.2.3 After the test:

For a single test the result is displayed constant in the main field.

**Click SAVE now if you wish to record your results.**

To perform another test press the TEST button (continuity indicators must be green).

**NOTE :** Soft key 1 toggles continuous / single test.

Soft keys 2 / 3 cycles through current ratings; default is 2 A, selectable 1 A, 100 mA, 10 mA, 1 mA.

Soft key 4 is only active in bidirectional resistance mode and toggles between 'Display previous 2 results' / 'Forward and reverse direction'.

TICK button sets new reference value.

For a continuous test results in the secondary screen will keep updating. Tests will be performed back to back.

'Two previous results' in the secondary screen, left is previous result and right is the result before that.

To stop the test press the TEST button.

If continuity is maintained, pressing the TEST button will start a new test

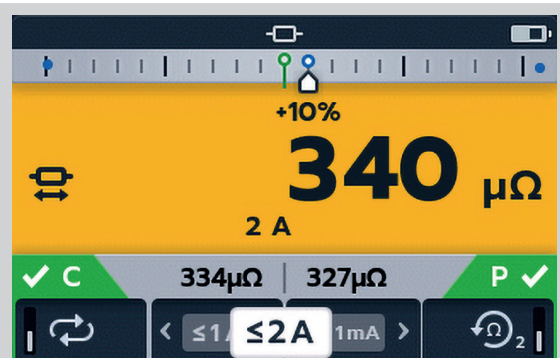

## 8. Tests: Long leads mode

Long leads resistance test mode has been designed for use with test leads of very long length.

The Difference Meter is disabled in long leads mode.

All readings are displayed in mΩ.

Minimum current is 1 A.

Restricted to single tests.

In long leads mode, all soft keys are inactive. The test is pre-set to single measurement, 1 A with previous 2 results displayed.

### 8.1 Long leads mode - auto and manual start

1. Turn rotary switch to select the long leads mode, either MANUAL or AUTO position.

**NOTE :** To AUTO SAVE results click the SAVE (  ) button now (Refer to 5. Data storage (DLRO2X only) on page 22).

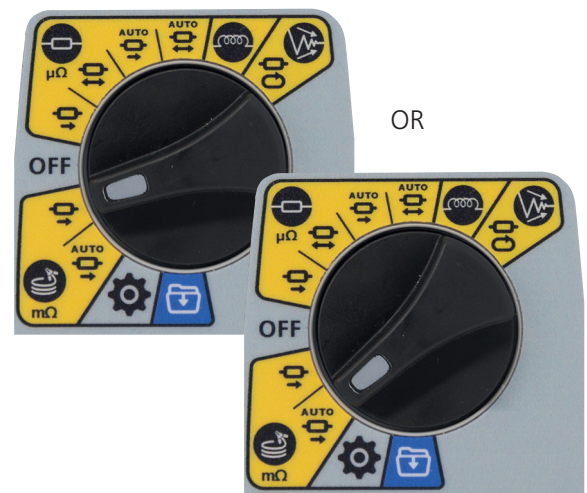

Long leads test screen appears, either 'Long Leads Mode - Manual Start' or 'Long Leads Mode - Auto Start' will show in the secondary field for a short time, the text then disappears to reveal the previous results fields.

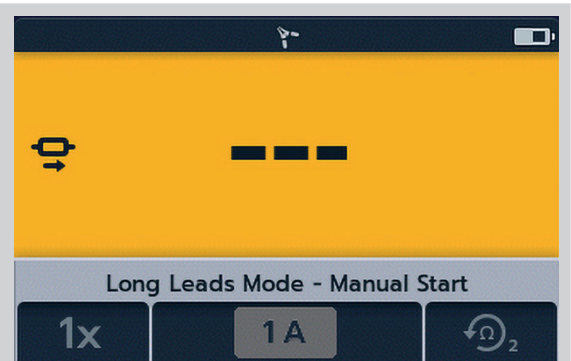

2. Connect C1-C2 and P1-P2 to the instrument and the unit under test.

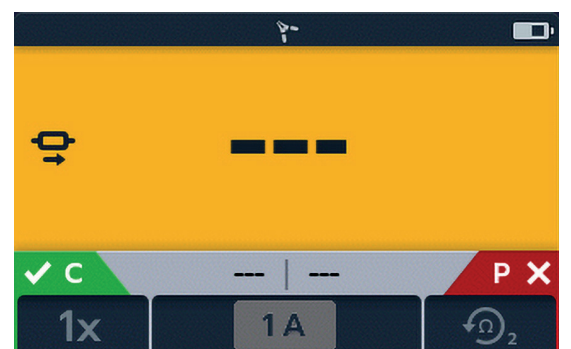

## Tests: Long leads mode

C and P indicators show red background with **✗** for no continuity or green background with **✓** for good continuity.

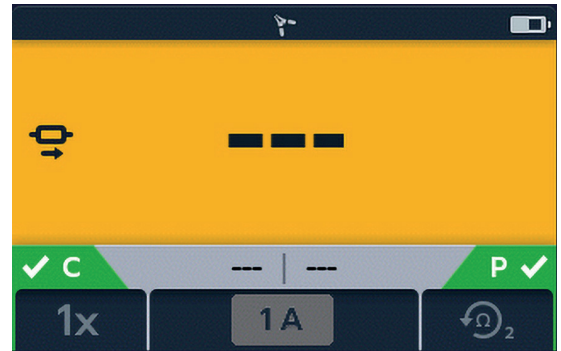

### 8.1.1 For manual mode

Proceed when both show green background with **✓**.

3. To start the test press the TEST button.

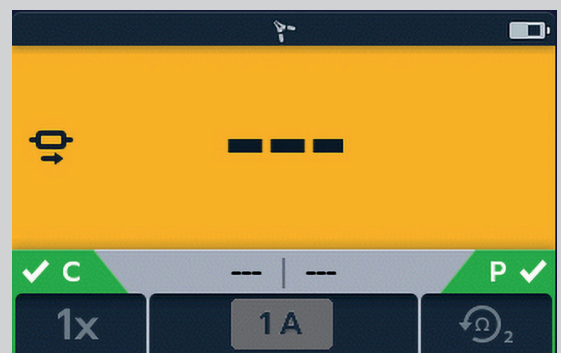

During the test, continuity indicators will fade.

The dashes (or an old result) will flash until a new result is displayed.

On the secondary display dashes or previous results will flash until a new result is ready.

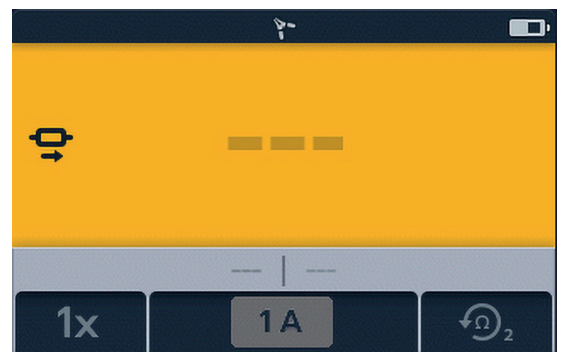

For a single test the result is displayed constant in the main field. No latest results are displayed in the secondary field unless multiple tests have been made in this sequence.

If continuity is maintained, pressing the TEST button will start a new test.

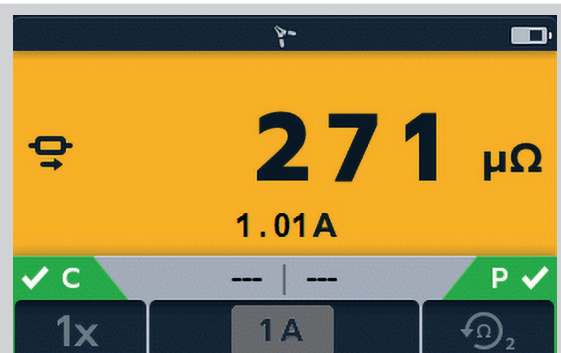

### 8.1.2 For auto mode

In auto-start mode the instrument will start the test when continuity is established. If both C and P continuity is made before the test mode is selected, the continuity flags will be shown in grey – this means that the user must disconnect and reconnect or press the TEST button to start the test.

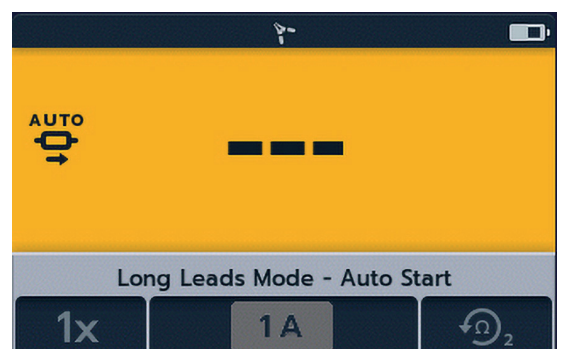

During the test, continuity indicators will fade.

The dashes (or an old result) will flash until a new result is displayed.

On the secondary display dashes or previous results will flash until a new result is ready.

The test will run automatically.

If required, to stop the test press the TEST button or break continuity.

For a single test the result is displayed constant in the main field. No latest results are displayed in the secondary field unless multiple tests have been made in this sequence.

**NOTE :** The TICK button (👉) will clear the previous results in the secondary fields.

Two previous results appear in the secondary fields, left is the previous result and right is the result before that.

For auto single tests the continuity indicators are grey, indicating that to repeat the test the leads must be disconnected and reconnected again.

If the test has been stopped by the TEST button the continuity indicators will be grey.

If continuity already is shown on the C and P connectors press the TEST button to re-start the test.

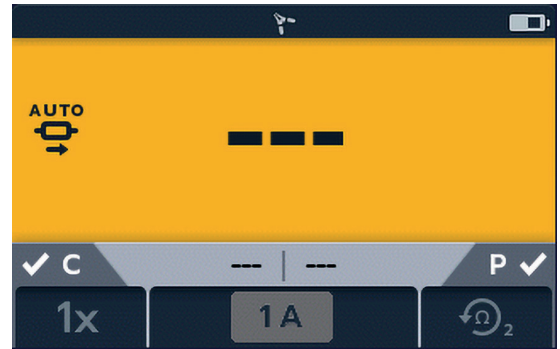

## 9. Tests: Noise rejection mode (DLRO2X)

If the high noise indicator  appears on the display while using either the normal mode, long test lead mode or the inductive mode, then the measurement is being affected by noise and the results may not be reliable. Noise can also cause consecutive readings to vary significantly. The cause of this is usually from a noise current flowing through the connection or joint being measured, or the induction of noise into the test leads. Interfering noise current will result in measurements that are not repeatable, varying, out of specification and not useable.

To assist with this situation the DLRO2X is equipped with a **noise rejection test mode**. In this test mode the current is passed continuously and in one direction only. The instrument then feeds a stream of measurements into our patented Confidence Meter™. The measurement is then refined until a stable, accurate measurement is obtained.

- All readings are displayed in mΩ.
- Minimum current is 1 A.
- Restricted to single tests.
- In high noise mode, all soft keys are inactive.
- The test is pre-set to single measurement, 1 A with previous 2 results displayed.

### 9.1 Confidence Meter™

1. If it is not possible to obtain a stable, accurate measurement in the normal, long lead or inductive test modes, turn the rotary switch to select the noise rejection mode , which will take a series of measurements and feed them into the Confidence Meter™.

**NOTE :** To AUTO SAVE results click the SAVE (  ) button now (Refer to 5. Data storage (DLRO2X only) on page 22).



2. Connect C1-C2 and P1-P2 to the instrument and the unit under test. Proceed when both show green background with .

The test current applied will be continuous and up to 1A, so for this reason the instrument will start the measurement with a charging cycle similar to the inductive test mode. The test current will then be increased as high as possible, up to 1A.

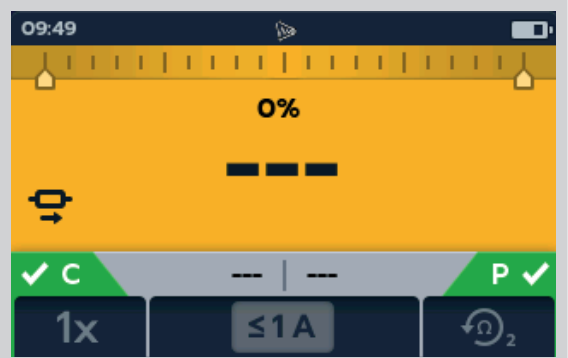

3. To start the test press the TEST button. Once the first measurements start to appear on the display the Confidence Meter™ will start to operate. At the top of the display two markers will indicate the level of confidence the instrument has with the measurement. Starting far apart at 0% confidence.



4. As the Confidence Meter™ starts to calculate and average out the measurements the displayed value will become more stable and the markers will start to move inwards as the confidence percentage increases. The markers also change colour as they move inwards, starting at red and changing to yellow and then green as confidence increases. In cases where noise levels are high or varying the pointers may move outwards and inwards as confidence fluctuates.



5. When the test stops the instrument will enter the discharge phase.

**WARNING : Do not disconnect test leads until discharge is completed.**

During the discharge phase, the buttons and rotary switch will be inactive. While discharging is still in progress a warning symbol (⚡) will flash on the left of the screen and an audible warning buzzer will sound. Do not remove the test leads until discharge is complete and the warning disappears.



6. The Confidence Meter™ will read 100%. The test leads can be disconnected and the results can be saved by clicking the SAVE (💾) button.

When confidence reaches 100% the measurement will stop and the instrument will apply a discharge cycle, just in case the test piece was inductive. When complete the final value will be displayed and held, at this point the test limits, if enabled, will be applied and a pass or fail indicated.



In the event that noise is very high testing may continue for up to 5 minutes. If after this time 100% confidence has not been reached, the instrument will stop the test and indicate the level of confidence achieved and the best measurement value it has been possible to obtain. Should the user wish to stop the test earlier, the user can press the TEST button at any time.

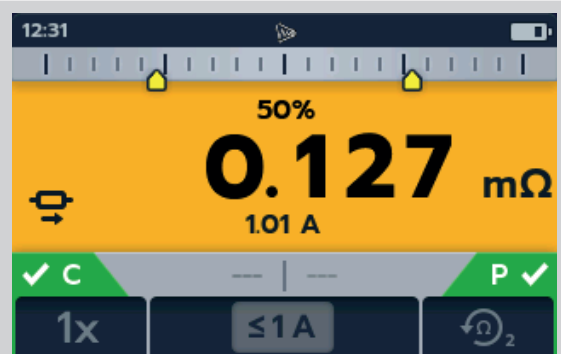

There may be occasions where the measured value is actually stable, but the Confidence Meter™ is still indicating a lower level of confidence, such as 50% for example. In this situation the user may be happy with the stable value and choose to stop the test by pressing the TEST button. This is usually because the Confidence Meter™ is trying to resolve the measurement to a higher resolution than is currently displayed.

## 10. Error and Warning Conditions

If an error code appears on the display follow the on screen instructions.

### 10.1 Error code categorisation

Item	Number Range	Description	User Action
1	1 - 999	Non dismissible errors	Restart unit to recover.
2	1000 - 1999	User dismissible errors	Press  to continue
3	2000 - 2999	Auto dismissible errors	eg voltage present warning disappears when voltage goes
4	3000 - ....	Logged only errors	No user intervention

### 10.2 On screen error messages

#### 10.2.1 Error screen A

1. Error code.
2. Error text, where applicable, explains what went wrong.

Remove the message by pressing the TICK button ().

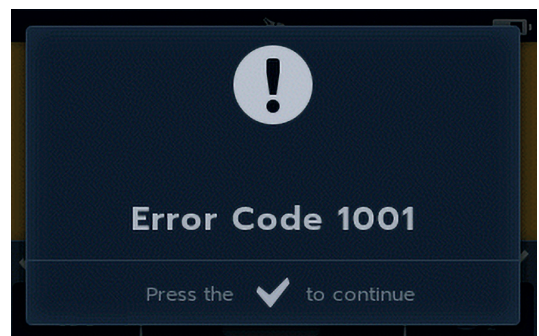

#### 10.2.2 Error screen B

1. Error code.
2. Error text, switch the DLRO2 OFF then back ON. If the problem persists contact **Megger**.

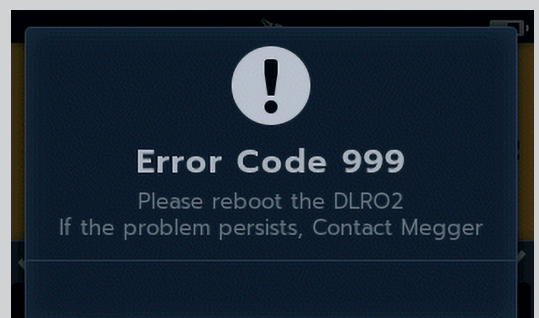

#### 10.2.3 Fuse failure

The fuses in DLRO2 are not user replaceable. If there is no continuity between the C terminals this will indicate that the internal fuse has been blown. The unit must be returned to Megger to be repaired. Refer to 15. Calibration, Repair and Warranty on page 53.



## 11. Settings

In this section various user settings can be adjusted or accessed.

### 11.1 General settings

Switch the rotary switch to the settings mode (Refer to 9.1 General settings on page 28).



Go to the general settings tab . Use soft keys 1 and 4 to choose the next tab along the top of the settings screen.

Use soft keys 2 and 3 to move up and down the items in the general settings tab.

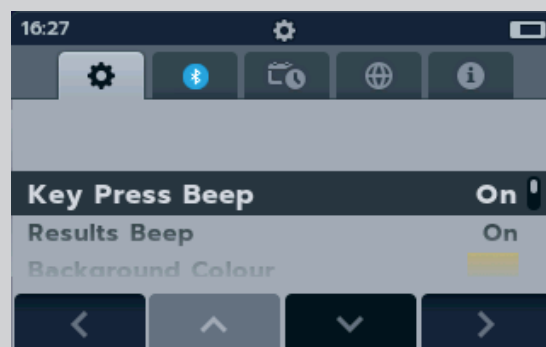

#### General settings

Key Press Beep	Can be set on or off.
Results Beep	Can be set on or off.
Background Colour	Toggle between yellow and white using the tick button.
Backlight Timer	Use soft keys 2 and 3 to select from off up to 60 seconds (default is 20 seconds).
Battery Technology	Toggle between NiMH and alkaline using the tick button.
Difference Meter	Toggle ON and OFF using the tick button.
Lower Test Limit	Choose $\mu\Omega$ , m $\Omega$ or $\Omega$ ranging from 1s to 9000s (default is 1 $\mu\Omega$ ). Refer to 4.2.5 Setting test limits (DLRO2X) on page 20
Upper Test Limit	Choose $\mu\Omega$ , m $\Omega$ or $\Omega$ ranging from 1s to 9000s (default is 2000 $\Omega$ ). Refer to 4.2.5 Setting test limits (DLRO2X) on page 20
Pass Colour	For colour blind users the pass colour can be changed from green to blue
Restore Factory Settings	Select using the TICK button (✓). When the prompt screen appears, press and hold the TICK button (✓) for 3 seconds.
Calibration	Not user accessible.

## 11.2 Test Limit Pass Colour setting (DLRO2X)

When a test is complete the result will be shown in the Default Green colour. Some people who are colour blind may not be able to distinguish between green and red but can between blue and red.

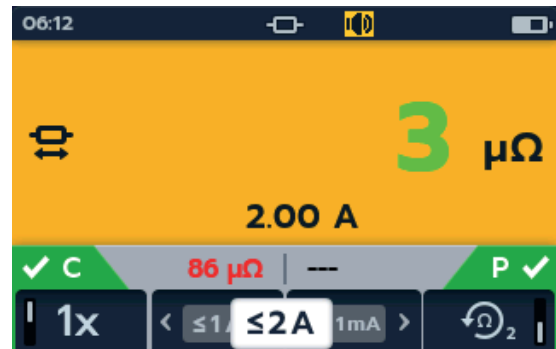

1. The Pass Colour can be changed to Blue which is easier to read by colour blind users. Select **Pass Colour** on the Settings menu and press the TICK button (✓).

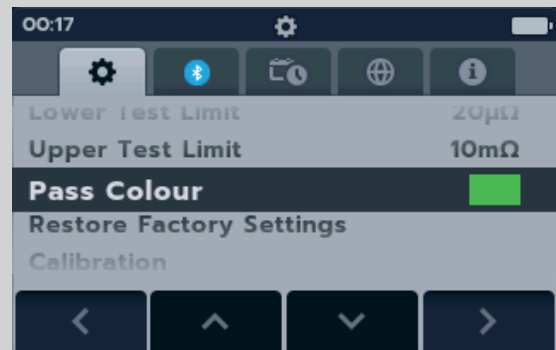

2. The Pass Colour will change to Blue.

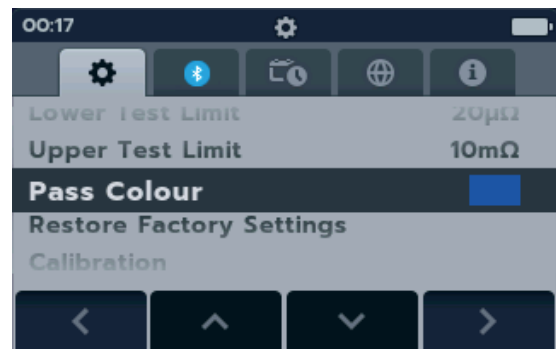

3. Now, when a test is complete, the result will be shown in the Blue colour.

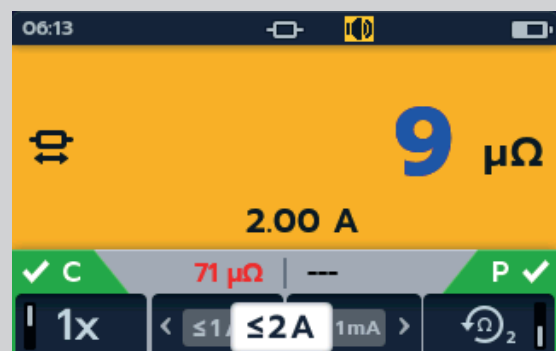

4. The colour of the result when a test fails will always be Red and cannot be changed.

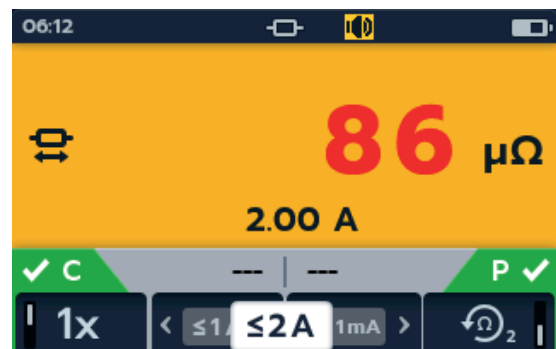

### 11.3 Bluetooth settings (DLRO2X)

Go to the bluetooth settings tab .

Use soft key 2 to select required setting as listed below.

Press the TICK button (👉) to choose which one to edit.

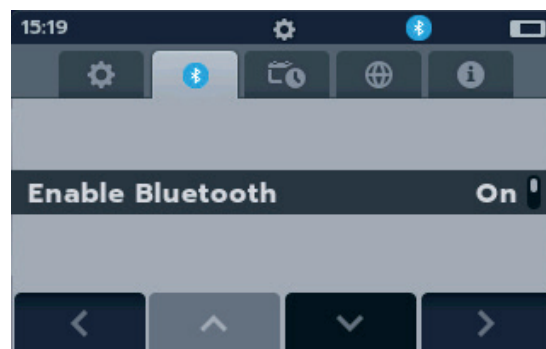

#### Bluetooth settings

Bluetooth	Turn Bluetooth on or off
Bluetooth Name	Name your unit for connecting to other Bluetooth devices

### 11.4 Date and Time settings (DLRO2X)

Go to the Date and Time settings tab .

Use soft key 2 to select required setting as listed below.

Press the TICK button (👉) to choose which one to edit.

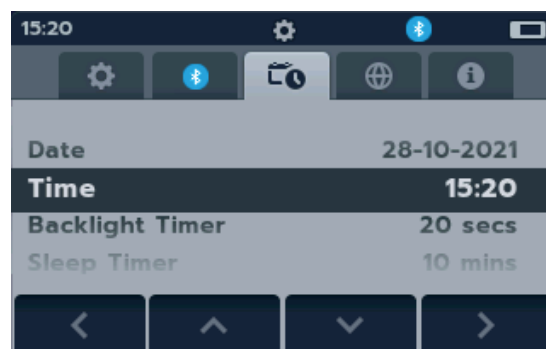

#### Date and Time settings

Date	Set the date using the soft keys and the TICK button (👉) to select.
Time	Set the date using the soft keys and the TICK button (👉) to select.
Backlight Timer	Set to either 0, 20 secs or 60 secs before backlight dims.
Sleep Timer	Press the tick button and navigate using soft keys 2 and 3. Use the tick button to set.

### 11.5 Language settings

Switch the rotary switch to the settings mode (Refer to 9.1 General settings on page 28).

Go to the language settings tab .

Use soft keys 2 and 3 to highlight a language, and press the TICK button (👉) to select the highlighted language. Available languages are English, French, German, Spanish, Latin American, Portuguese, Dutch and Italian.

Changing the set language changes the on screen display language and the keyboard layout.

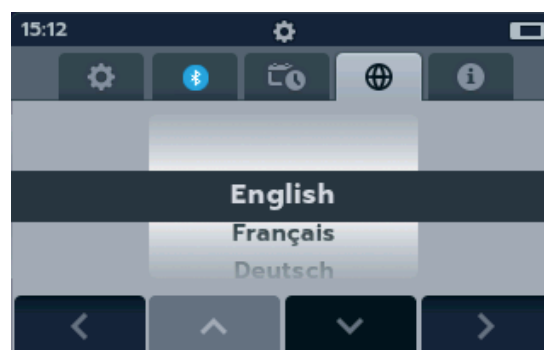

## 11.6 Instrument Information

Go to the instrument information tab .

Instrument information is read only, displaying:

- Product serial number
- Date of calibration
- Measurement version
- GUI version

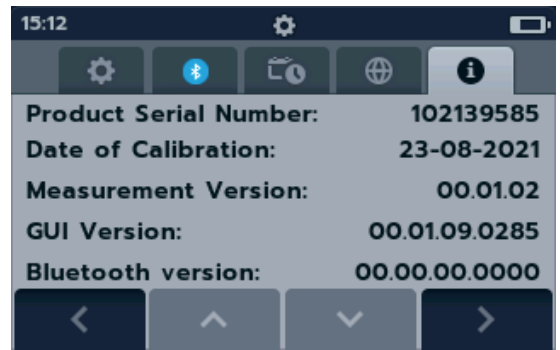

## 11.7 Firmware update

The USB port on top of the DLRO2 range is for firmware updates.

There are two parts to a firmware update; the first part updates the user interface while the second part updates the measurement firmware. A firmware update file may include either or both of these. Connect a USB flash drive to the DLRO2 with the firmware update file in the root directory. The DLRO2 will automatically update when the instrument is turned on if a firmware update file is found on the USB flash drive.



1. Plug the USB flash drive in to the USB slot at the top of the instrument. Turn OFF. Wait 3 seconds and turn back ON.
2. The boot loader screen will be displayed when the instrument starts up.
3. Press [OK] to upgrade firmware or [TEST] to cancel.
4. The unit will progress through various stages.

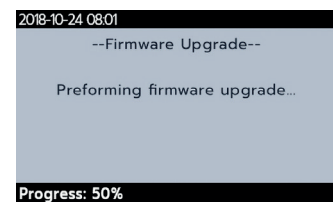
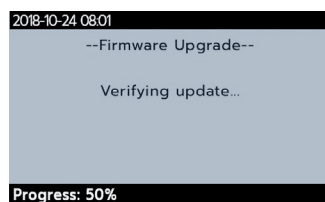
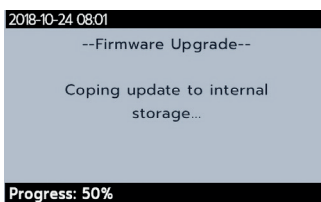
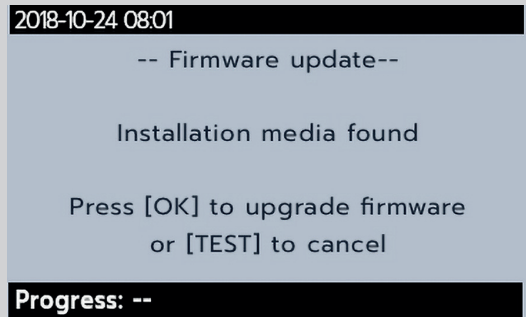

5. When complete, remove the USB flash drive.
6. Restart the DLRO2 (turn off and on).
7. If a measurement firmware update is to be performed, then the measurement firmware update screen will display. At the end of the firmware update, the instrument will automatically restart.

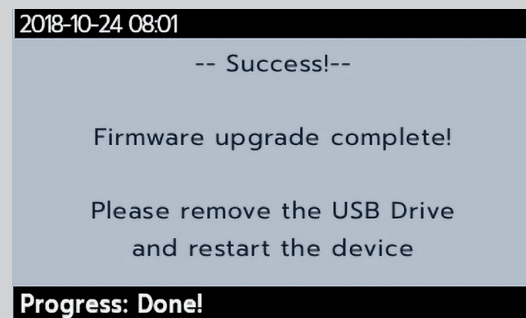

## 12. Maintenance

**NOTE :** There are no user replaceable parts within the DLRO2.

### 12.1 General Maintenance

- Test leads should be checked before use for damage and continuity.
- Ensure the unit is kept clean and dry after use.
- Close all covers when not in use.

### 12.2 Cleaning

1. Disconnect from mains power.
2. Wipe the instrument with a clean cloth dampened with either water or isopropyl alcohol (IPA).

### 12.3 Battery

**WARNING :** Always set the instrument to Off and remove test leads before batteries are removed or installed.

**CAUTION :** Old batteries must be disposed of in accordance with local regulations.

**CAUTION :** Only use approved batteries as defined below.

Replacement battery types are: 6 x IEC HR6 NiMH (rechargeable) or LR6 AA Alkaline (non rechargeable). Refer to Specifications on page 34.

Battery technology (battery type) can be selected between alkaline or NiMH. When changing between battery types always ensure the correct type is selected in the settings menu, failure to do this may result in incorrect battery level indication and may prevent charging. Refer to 9. Settings on page 28

To help maintain the health, reliability and longevity of the installed batteries:

- Ensure if using rechargeable batteries they are fully charged before use (charger supplied).
- Store batteries in a cool, dry place. Batteries can be damaged when exposed to heat.

#### 12.3.1 Battery status

**WARNING :** Do not recharge Alkaline batteries.

The battery condition icon is positioned at the top right hand corner of display. This icon is displayed at all times when the DLRO2 is switched on. When running the icon will indicate state of charge, the icon will be filled in proportion to the state of charge.

When the battery is in a good state of charge the battery icon will be white and in a low state of charge the battery icon will flash.

When the battery is very low a large red battery icon will appear in the primary field with the message '**Battery low please charge or replace to continue**'. No tests will be able to be performed but changes to settings and data handling can be carried out. The battery must be recharged (NiMH) or replaced (Alkaline) before the DLRO2 can be used.

When the battery is charging, it will show an animation of the battery from empty to full, then repeats. Once the battery is full, the animation stops.

The maximum charging time for NiMH batteries is 6 hours, normal charging time is approximately 4 hours.

### 12.3.2 12 V Supply

When charging NiMH rechargeable batteries, only use the power supply provided by **Megger**. Other power supplies will not function with the DLRO2. The **Megger** power supply is designed to preserve the functions and accuracy of the DLRO2.

### 12.3.3 Battery Charging

When charging NiMH rechargeable batteries, only use the power supply provided by **Megger**. Other power supplies will not function with the DLRO2. The **Megger** power supply is designed to preserve the functions and accuracy of the DLRO2.

**WARNING : ONLY NiHM batteries are rechargeable.**

When charging the DLRO2 while the instrument is OFF, an animated battery will display across the screen to show charging is taking place. Once the battery is fully charged the screen will display a solid green battery.

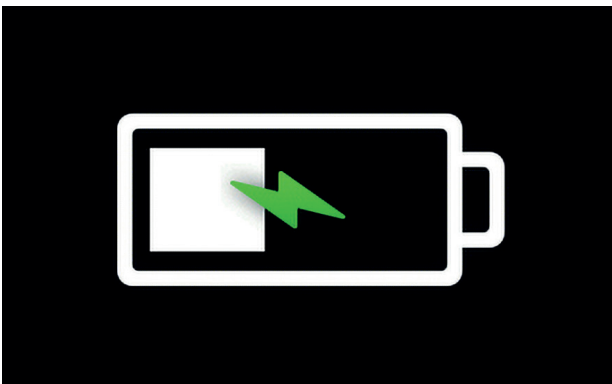

Battery charging

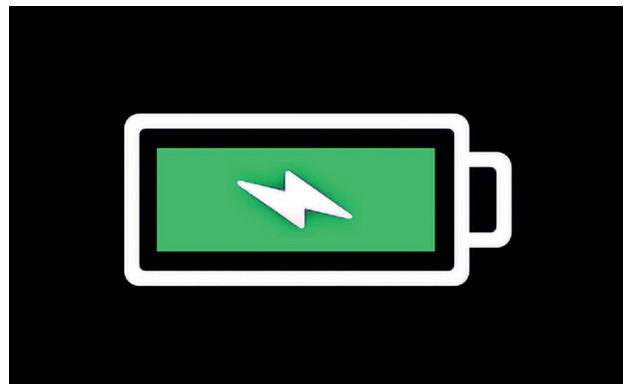

Battery fully charged

When charging the DLRO2 while the instrument is ON, an animated battery will display in the top right hand corner of the screen. Tests cannot be performed while the charger is connected. If the TEST button is pressed the buzzer will sound. However the Settings are fully accessible while the instrument is charging.

### 12.3.4 Battery error screens

#### Battery Low

The battery is too low to perform a test.

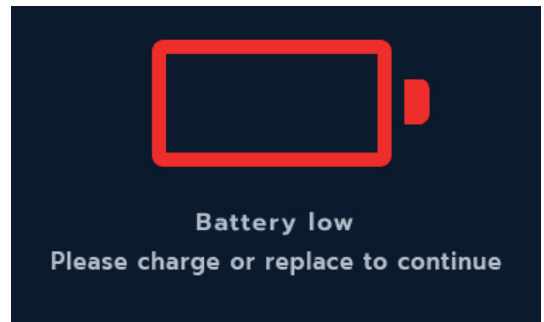

#### Charging Fault

A generic charging fault warning screen.

Turn off and disconnect the charger. Then reconnect and try again.

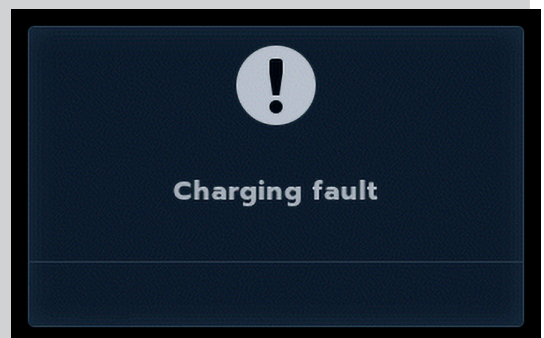

## 12.4 Battery Replacement

**WARNING :** Remove all test leads before removing the battery cover.

**CAUTION :** Batteries should not be left in the instrument if remaining unused for an extended period.

No.	Description	Quantity
1	Screw, captive	1
2	Cover, battery	1
3	Battery isolation tab	1
4	Batteries	6

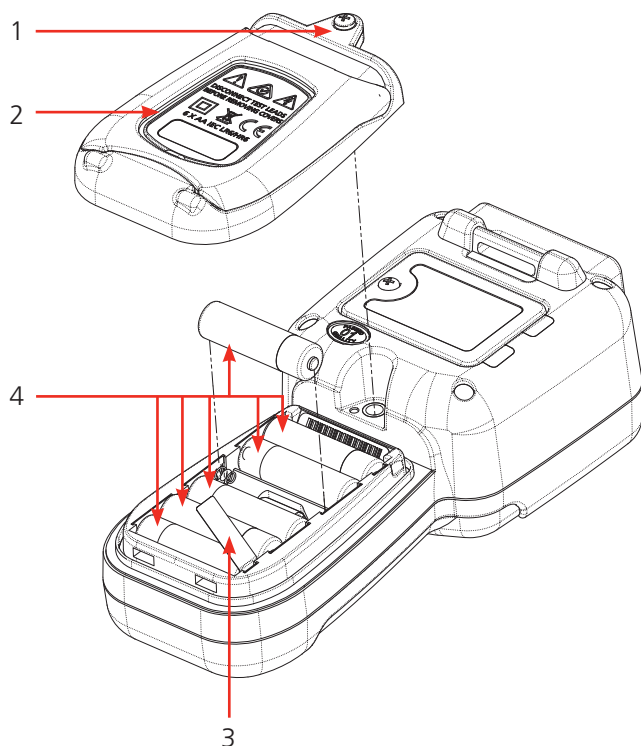

### 12.4.1 Replace batteries and remove isolation tab

The batteries are housed in the lower section of the DLRO2, behind the rotary switch. Looking at the back of the instrument, the lower (battery) cover incorporates a stand and has the replacement cell types written on it.

**NOTE :** If using the DLRO2 for the first time remove and discard the battery isolation tab (3).

1. Remove the test leads and ensure the DLRO2 is switched off.
2. Slacken one captive cross-point screw (1) which is centred at the top of the cover.
3. Battery cover (2) will now lift away from the top.
4. Ease out of lugs at the bottom of the cover.
5. The six batteries (4) can now be lifted out of the compartment.

**CAUTION :** Ensure the new cells are replaced in the correct polarity as indicated on the cells and battery compartment.

**CAUTION :** Ensure all batteries are of the same type, do not mix NiMH or Alkaline.

1. Replace all six batteries (4).
2. Replace the battery cover (2) in reverse order to above.
3. Re-secure with screw (1).
4. If the type of batteries has changed (NiMH or Alkaline) ensure the battery technology setting is changed.  
*Refer to 11. Settings on page 41.*

## 12.5 Restore Factory Settings

The unit can be reset back to factory settings to remove any personalised settings that have been created.

**WARNING : Resetting the device will DELETE all stored results. Back up all results to USB stick and remove the USB stick before continuing to reset the unit.**

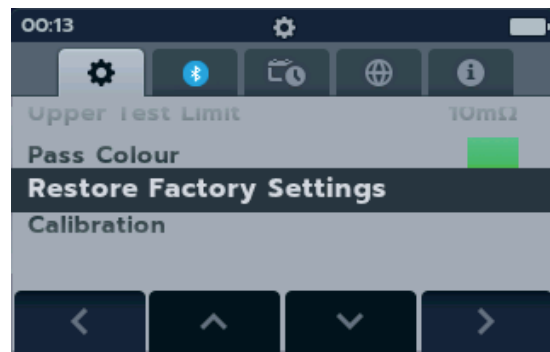

1. Hold the TICK button (✓) for 3 seconds to confirm that you want to restore to factory settings.

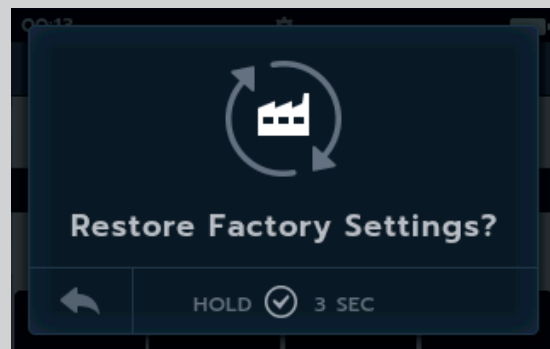

2. Confirm that you wish to delete all the saved results on the unit by pressing soft key 4.

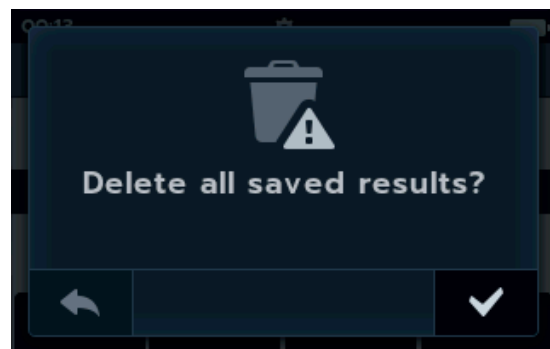

3. The unit will restart





## 13. Specifications

Specification	Detail				
<b>PHYSICAL</b>					
<b>Dimensions:</b>	228 x 105 x 75 mm (8.98 x 4.1 x 2.95 in)				
<b>Display:</b>	Full LCD colour screen with user configurable backlight.				
<b>Weight:</b>	905 grams (with batteries)				
<b>SAFETY AND ELECTRICAL PROTECTION</b>					
<b>Safety rating</b>	CATIII 600 V / CATIV 300 V to EN 61010, IEC 61010-031 : 2015, IEC 61010-030 Safety category rating valid to altitude of 3000 m				
<b>Live voltage</b>	Active live voltage protection to 600 V between any test terminals without blowing a fuse. Live voltage warning on display and audible when >5 V is applied between any test terminals. Fuse protected to 1000 V, fuses are not user changeable.				
<b>LOW RESISTANCE MEASUREMENT</b>					
<b>Resistance measurement test modes:</b>	Normal test mode, Fast mΩ/long test lead mode and Inductive test mode (Resistance of inductive loads)				
<b>Overall resistance range:</b>	1 μΩ – 2000 Ω				
<b>Max resistance across C terminals:</b>	2 A with up to 1.1 Ω total resistance and 1 A with up to 3.2 Ω total resistance				
<b>Basic accuracy:</b>	Bi-directional test current mode: + /- 1% +/- 2 digits Uni-directional test current mode: + /- 1% +/- 10 digits Inductive mode or unidirectional mode will introduce an undefined error if an external EMF is present				
<b>Resistance measurement ranges:</b>					
Full Scale Resistance	Test Current	Resolution	Normal Resistance Mode	Inductive Mode	Long Test Lead Mode (1 A only)
15000 μΩ	2.00 A	1 μΩ	✓		
120.00 mΩ	2.00 A	0.01 mΩ	✓		
1000.0 mΩ	2.00 A	0.1 mΩ	✓		
30.000 mΩ	1.00 A	0.001 mΩ	✓	✓	✓
220.00 mΩ	1.00 A	0.01 mΩ	✓	✓	✓
2000.0 mΩ	1.00 A	0.1 mΩ	✓	✓	✓
300.00 mΩ	100 mA	0.01 mΩ	✓		
2500.0 mΩ	100 mA	0.1 mΩ	✓		
20.000 Ω	100 mA	0.001 Ω	✓	✓	
3000.0 mΩ	10.0 mA	0.1 mΩ	✓		
24.000 Ω	10.0 mA	0.001 Ω	✓		
200.00 Ω	10.0 mA	0.01 Ω	✓	✓	
30.000 Ω	1.00 mA	0.001 Ω	✓		
240.00 Ω	1.00 mA	0.01 Ω	✓		
2000.0 Ω	1.00 mA	0.1 Ω	✓	✓	
<b>TEST CURRENT OUTPUT</b>					
<b>Normal resistance test mode</b>					
<b>Current ranges:</b>	2 A, 1 A, 100 mA, 10 mA and 1 mA				
<b>Maximum compliance output voltage:</b>	3.24 V (1 A mode) 2.2 V (2 A mode)				

## Specifications

Specification	Detail
<b>Current output accuracy:</b>	Normal and Inductive mode: $\pm 10\%$ , Long test lead mode: $+10\% -0\%$ At all battery conditions except with low battery indication
<b>Thermal EMF / Seebeck effect compensation:</b>	Yes, average of forward and reverse test current measurements
<b>ENVIRONMENT</b>	
<b>Noise immunity:</b>	Less than 1% $\pm 20$ digits additional error with 80 mV peak 50/60 Hz with on screen noise indicator. Less than 1% $\pm 20$ digits additional error with 80 mV peak 400 Hz with on screen noise indicator. Noise rejection mode (DLRO2X) = 60 mV peak random noise.
<b>EMC:</b>	IEC61326-1, industrial specification IEC61326-2-2
<b>Dust and moisture ingress:</b>	IP54 to IEC60529 in use
<b>Altitude:</b>	Operational to 3000 m
<b>Temperature:</b>	Operational range 0 °C to 50 °C, Storage range -20 °C to 50 °C
<b>Humidity:</b>	Operational to 95 % Storage to 90 %
<b>DATA STORAGE:</b>	
<b>Total maximum test measurement records:</b>	8 million
<b>Maximum Asset ID references:</b>	256
<b>Maximum test measurement records per asset, per day:</b>	256
<b>Note:</b> continuous tests will contain multiple test measurements	
<b>POWER SUPPLY</b>	
Rechargeable 6 x HR6 Ni MH batteries with in unit fast charge (also ability to use non-rechargeable Alkaline AA batteries (LR6))	
<b>Battery charge time:</b>	< 4 hours
<b>Battery life:</b>	>1000 bi-directional tests at 2 A into a 1 $\Omega$ load
<b>BATTERY CHARGER ADAPTOR:</b>	
<b>Mains / line input voltage:</b>	100-240 V
<b>Mains / line input frequency:</b>	47-63 Hz
<b>Output:</b>	12 V DC 1.2 A 14.4 W max.
<b>Type:</b>	Travel adaptor / interchangeable plug adaptor
<b>Plug types:</b>	Australia, USA, Europe and UK plugs
<b>CONNECTIONS</b>	
<b>Test terminals:</b>	4 X 4 mm shrouded sockets
<b>Data:</b>	USB (For firmware updates and data transfer (DLRO2X only)) User may update instrument firmware to latest version themselves
<b>Battery charger:</b>	2.5 mm DC jack connector
<b>LANGUAGES</b>	
<b>User Interface:</b>	English, French, German, Spanish, Latin American, Portuguese, Dutch and Italian
<b>User guide:</b>	English, French, German and Spanish

## 14. Accessories and Equipment

### 14.1 Included Accessories

Item	Order No.
DLRO2, Ducter Low Resistance Ohmmeter 2 A	1012-280
DLRO2X part number is	1013-795
<b>Test leads:</b>	
Kelvin clip lead set, CAT III 600 and CAT IV 300	1011-928
Kelvin probe lead set CAT III 600 and CAT IV 300	1011-929
<b>Accessories:</b>	
240 V charger power supply	1002-736
Batteries: Six 1.2 V NiMH AA 2000mAH	1002-735
USB memory stick (with user guide)	
Hanging hook and strap	1012-068
Soft pouch	1012-063

### 14.2 Optional Accessories

Item	Order No.
<b>Test leads:</b>	
Set of 4 Kelvin probe pins. Replacement probe tips.	1012-064
4 right angled adaptors to allow hook terminated (E.g. KC100) leads to fit DLRO2	1012-511
10 A Fused test probe and clip lead set	1013-224
DLRO2 current and potential leadset 2m. 2 x red lead, 2 x blk lead, 2 x grabber clip, 2 x probe	1011-673
KC50C-KIT Kelvin clamp/probe reel (50 m)	1013-211
KC100C-KIT Kelvin clamp/probe reel (100 m)	1013-212
KC50E Extension reel (50 m)	1013-213
Full calibration certificate DLRO2	1013-170
UKAS calibration certificate DLRO2	1013-169
Full calibration certificate DLRO2X	1014-436
UKAS calibration certificate DLRO2X	1014-437

### 14.3 Download PowerDB

You can now download direct from the Megger website to ensure that you have the most recent version available. Visit [megger.com/powerdb](http://megger.com/powerdb)

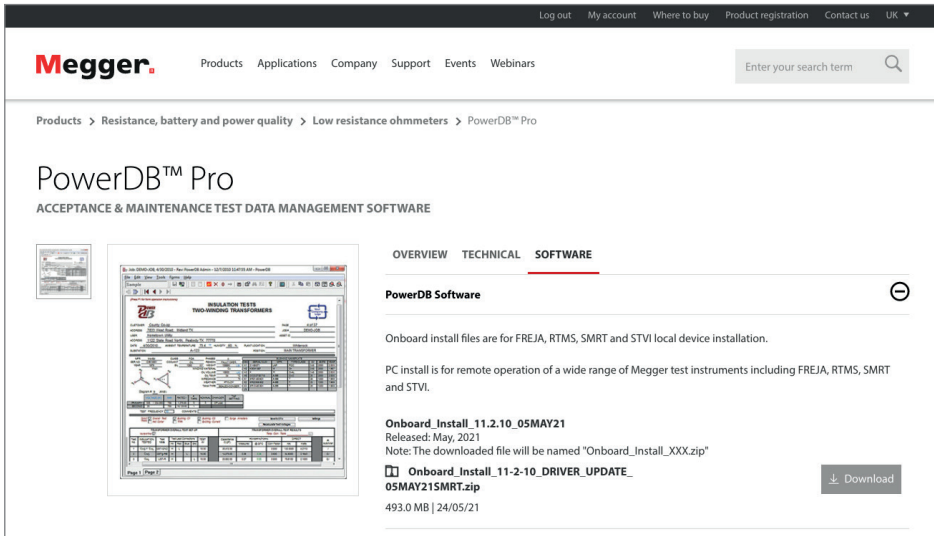

The latest edition will be at the top. Click the “download” button beside the file.

This will ask if you want to open or save the file. By clicking “Save” you will begin to download the installation package, then just follow the onscreen instructions to complete installation.

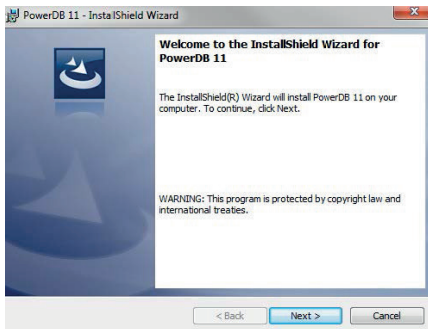

## 15. Calibration, Repair and Warranty

**Megger** operate fully traceable calibration and repair facilities to make sure your instrument continues to provide the high standard of performance and workmanship that is expected. These facilities are complemented by a worldwide network of approved repair and calibration companies, which offer excellent in-service care for your **Megger** products.

For service requirements for **Megger** instruments contact:

### **Megger Limited**

Archcliffe Road  
Dover  
Kent  
CT17 9EN  
UK  
Tel: +44 (0) 1304 502 243  
Fax: +44 (0) 1304 207 342

### OR **Megger Valley Forge**

400 Opportunity Way  
Phoenixville,  
PA 19460  
U. S. A.  
Tel: +1 610 676 8579  
Fax: +1 610 676 8625

### 15.1 Returns procedure

**WARNING : Remove the battery cells before shipping this instrument.**

UK and USA Service Centres

1. When an instrument requires recalibration, or in the event of a repair being necessary, a Returns Authorisation (RA) number must first be obtained from one of the addresses shown above. The following information is to be provided to enable the Service Department to prepare in advance for receipt of your instrument and to provide the best possible service to you:
  - Model (for example, DLRO2).
  - Serial number (found on the display under settings, device information, or on the rear cover and by the batteries or on the calibration certificate).
  - Reason for return (for example, calibration required, or repair).
  - Details of the fault if the instrument is to be repaired.
2. Make a note of the RA number. A returns label can be emailed or faxed to you if required.
3. Pack the instrument carefully to prevent damage in transit.
4. Before the instrument is sent to **Megger**, freight paid, make sure that the returns label is attached or that the RA number is clearly marked on the outside of the package and on any correspondence. For items being returned outside of the UK and USA please send copies of the original purchase invoice and packing simultaneously by airmail to expedite clearance through customs. In the case of instruments which require repair outside the warranty period, an immediate quotation can be provided when obtaining the RA number.
5. Track the progress on line at **www.megger.com**.

## 16. Decommissioning

---

### 16.1 WEEE Directive

The crossed out wheeled bin symbol placed on **Megger** products is a reminder not to dispose of the product at the end of its life with general waste.



**Megger** is registered in the UK as a Producer of Electrical and Electronic Equipment. The Registration No is WEE/ HE0146QT.

For further information about disposal of the product consult your local **Megger** company or distributor or visit your local **Megger** website.

### 16.2 Battery disposal

The crossed out wheeled bin symbol placed on a battery is a reminder not to dispose of batteries with general waste when they reach the end of their usable life.

The battery, is located under the battery cover on the back of the instrument. To remove the battery follow the instructions in *Refer to 12.4 Battery Replacement on page 47.*

For disposal of batteries in other parts of the EU contact your local **Megger** branch or distributor.

**Megger** is registered in the UK as a producer of batteries (registration No.: BPRN00142).

For further information see [www.megger.com](http://www.megger.com)

## 17. Worldwide Sales Offices

Sales Office	Telephone	Email
UK	T. +44 (0)1 304 502101	E. UKsales@megger.com
USA – Dallas	T. +1 214 333 3201	E. USsales@megger.com
USA – Valley Forge	T. +1 214 333 3201	E. USsales@megger.com
USA – Dallas	T. +1 214 333 3201	E. USsales@megger.com
DEUTSCHLAND – Aachen	T. +49 (0) 241 91380 500	E. info@megger.de
SVERIGE	T. +46 08 510 195 00	E. seinfo@megger.com
AUSTRALIA	T. + 61 2 9397 5900	E.
中国	T. +86 512 6556 7262	E. meggerchina@megger.com
中国 - 香港	T. +852 26189964	E. meggerchina@megger.com
ČESKÁ REPUBLIKA	T. +420 222 520 508	E. info.cz@megger.com
AMÉRICA LATINA	T. +1 214 330 3293	E. csasales@megger.com
ESPAÑA	T. +34 916 16 54 96	E. info.es@megger.com
SUOMI	T. +358 08 510 195 00	E. seinfo@megger.com
LA FRANCE	T. +01 30 16 08 90	E. infos@megger.com
ΕΛΛΑΔΑ	T. +49 (0) 9544 68 0	E. sales@sebakmt.com
MAGYARORSZÁG	T. +36 1 214-2512	E. info@megger.hu
ITALIA	T. +49 (0) 9544 68 0	E. sales@sebakmt.com
日本	T. +44 (0)1 304 502101	E. UKsales@megger.com
한국	T. +1-800-723-2861	E. sales@megger.com
ضاي رلا بة رب رل	T. +966 55 111 6836	E. MESales@megger.com
ن ب ر ل بة ك ل م م	T. +973 17440620	E. MESales@megger.com
NEDERLAND	T. +46 08 510 195 00	E. seinfo@megger.com
NORGE	T. +46 08 510 195 00	E. seinfo@megger.com
POLSKA	T. +48 22 2809 808	E. info.pl@megger.com
PORTUGAL	T. +34 916 16 54 96	E. info.es@megger.com
ROMÂNIA	T. +40 21 2309138	E. info.ro@megger.com
РОССИЯ	T. +7 495 2 34 91 61	E. sebaso@sebaspectrum.ru
SLOVENSKO	T. +421 2 554 23 958	E. info.sk@megger.com
SOUTH AFRICA	T. + 27 (031) 576 0360	E. sales.rsa@megger.com
TÜRKIYE	T. +46 08 510 195 00	E. seinfo@megger.com

## Local Sales office

---

Megger Limited  
Archcliffe Road  
Dover  
Kent  
CT17 9EN  
ENGLAND  
T. +44 (0)1 304 502101  
F. +44 (0)1 304 207342

## Manufacturing sites

---

Megger Limited  
Archcliffe Road  
Dover  
Kent  
CT17 9EN  
ENGLAND  
T. +44 (0)1 304 502101  
F. +44 (0)1 304 207342

Megger GmbH  
Weststraße 59  
52074 Aachen  
GERMANY  
T. +49 (0) 241 91380 500  
E. info@megger.de

Megger Valley Forge  
400 Opportunity Way  
Phoenixville,  
PA 19460  
USA  
T. +1 610 676 8500  
F. +1 610 676 8610

Megger USA - Dallas  
4545 West Davis Street  
Dallas TX 75237  
USA  
T. 800 723 2861 (USA only)  
T. +1 214 333 3201  
F. +1 214 331 7399  
E. USsales@megger.com

Megger AB  
Rinkebyvägen 19, Box 724,  
SE-182 17 Danderyd  
SWEDEN  
T. +46 08 510 195 00  
E. seinfo@megger.com

Megger USA - Fort Collins  
4812 McMurry Avenue  
Suite 100  
Fort Collins CO 80525  
USA  
T. +1 970 282 1200

**This instrument is manufactured in the United Kingdom.**

**The company reserves the right to change the specification or design without prior notice.**

**Megger is a registered trademark**

**The Bluetooth<sup>®</sup> word mark and logos are registered trademarks owned by Bluetooth SIG. Inc., and is used under licence.**